

ENERO
2024

TARIFA
GENERAL
N° 105

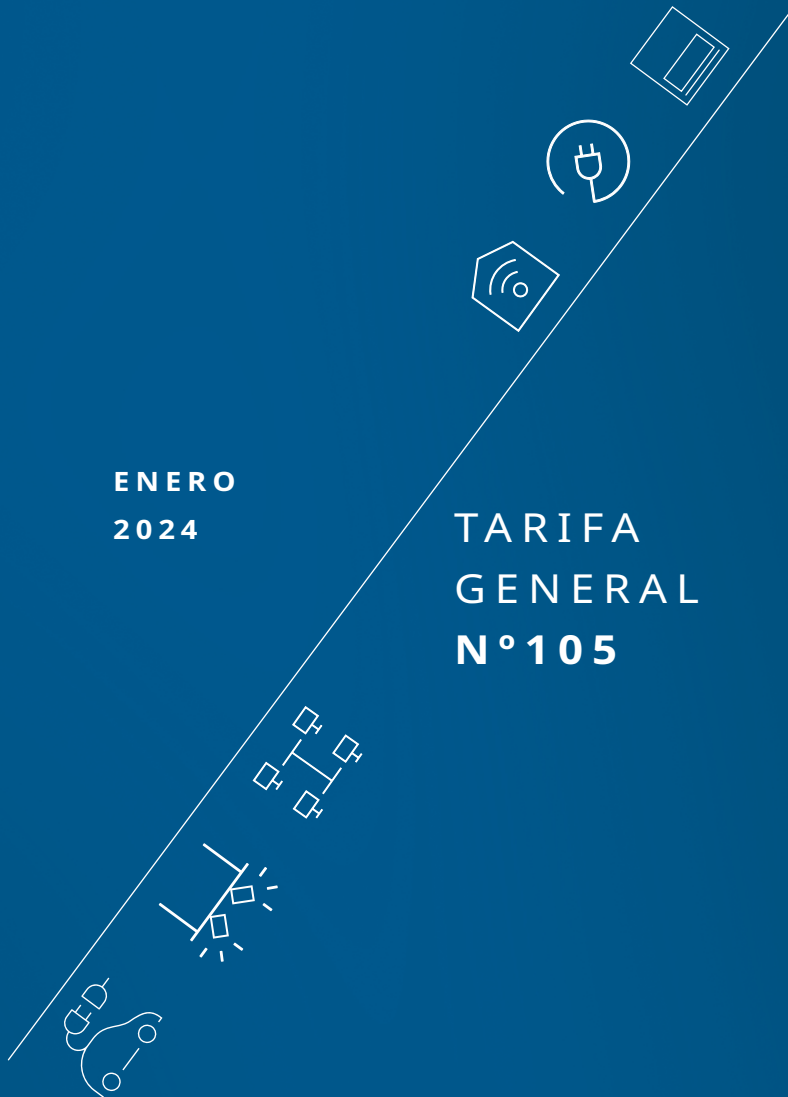

simon

ENERO
2024

TARIFA
GENERAL
N°105

NOVEDADES



COLECCIONES DE MECANISMOS

Soluciones USB Tipo C Powe Delivery

Completamos la gama de soluciones de carga USB tipo C con tecnología PowerDelivery.

Aumento de potencia de todos los cargadores A+C de 18 a 30W manteniendo la referencia ya existente.

Soluciones que combinan enchufe y puerto de carga USB en formato modular y kit de 2, 3 y 4 elementos.

USB tipo C en formato estrecho de un módulo para Simon|100 y Simon|270.



Simon|100

P. 48



Base de enchufe con cargador USB tipo C



Doble cargador USB tipo A+C



Cargador USB tipo C de un módulo

Simon|270

P. 68

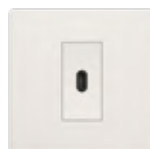

Simon|82

P. 68



Simon|270

P. 51

Acabado Blanco Mate

Todas las referencias de producto de Simon|270 ahora también en acabado blanco mate (-190). También para estética mínima.



Base de enchufe IP44

P. 51

Base de enchufe tradicional con tapa incluida y protección IP44 para entornos exigentes.



Base euroamericana

P. 51

Completamos la gama de bases internacionales para la serie Simon|270 incluyendo la base euroamericana en formato CLEAN.





ACCESORIOS

P. 51 Extensibles y prolongadores

Extensibles con 3 tomas y puertos de carga USB de 20 o 40 metros con protección IP55 y prolongadores con 2 o 4 tomas de 1,4 a 10 metros con protección IP44.



P. 51 Bases múltiples

Ampliación de gama de las bases múltiples y actualización de referencias existentes. Nuevo packaging fajín y Eruslot.



NOVEDADES



CONECTIVIDAD

P. 132 Simon | 400

Simon | K45 amplia su gama con puntos de conexión individuales de diseño compacto y circular que se integran en el mobiliario ocupando el mínimo espacio. La combinación de las tomas panelables individuales disponibles con cargador USB A+C y base de enchufe, se adaptan a las necesidades de cada puesto de trabajo.



P. 132 Nuevo cargador USB A+C 18W

Simon | K45 amplia su oferta de gama con las tomas de carga USB A+C para ofrecer una solución más completa para puestos de trabajo. Compatibles con 500 Cima gracias al adaptador de gama.





P. 132 **Caja de suelo metálica**

Fabricada con acero galvanizado, la caja de suelo metálica es un producto robusto y duradero. Está diseñada para entornos que requieren soportar grandes cargas y muy transitados como edificios del sector terciario (hoteles, hospitales, retail, etc).

Simon | **500**
Cima

Simon | **K45**



P. 132 **Bases internacionales**

Simon | K45 incorpora nuevas bases internacionales. Compatibles con Simon | 500 Cima gracias al adaptador de gama.



Británica



Sudafricana



Israelí



Suiza



Danesa

NOVEDADES



ILUMINACIÓN INTERIOR

P. 132 Simon | 712

El nuevo downlight lineal 712 se presenta en dos tamaños y dos formatos de instalación diferentes: empotrado y trimless. La versión trimless con sistema X-Less, lo convierte en una luminaria versátil ya que permite una completa integración en la pared o el techo. Además, permite una rotación del módulo lumínico de hasta 45° para lograr un efecto wall washer o su uso como baliza.



P. 132 Simon | 729

Luminaria modular que proporciona una iluminación homogénea y uniforme en espacios amplios, y un control del deslumbramiento.



P. 132 Simon | 719

Downlight de integración neutra y sutil que proporciona una iluminación general en entornos domésticos.





P. 132 Simon | 860

La nueva versión Simon | 860 se actualiza con CRI 90 para todas sus referencias y amplia su gama incorporando las versiones Tuneable White, que permite ajustar la temperatura de color de la luz para simular luz natural, y la versión con luz indirecta, diseñada para crear ambientes confortables y de bienestar.

Se añade también a la oferta de producto los nuevos tramos ciegos en forma de T y X para crear y configurar sistemas modulares con diferentes formas estructurales que se adaptan perfectamente a cualquier espacio.



P. 132 Simon | 650 Simon | 629

Los proyectores Simon | 650 y Simon | 629 están diseñados para entornos retail y pueden combinarse en espacios amplios o grandes superficies.



NOVEDADES



RECARGA VEHÍCULO ELÉCTRICO

Simon | Xenon

P. 79 Diseñado y concebido para crear una red de cargadores, Simon | Xenon te ayudará a convertir los aparcamientos en apuestas de sostenibilidad para evolucionar hacia una movilidad eléctrica más limpia y respetuosa.



P. 81 Simon | Neon

Accesorio módem 4G
Accesorio analizador SPL Trifásico
(Sirven para cualquier gama de producto Recarga de Vehículo Eléctrico)





Simon | SM34

Toda una vida juntos en casa Ahora también en tu garaje

El nuevo cargador para tu vehículo eléctrico



Controla la carga desde
la app Plug&Drive



Carga compatible
con tus placas solares



Servicio de instalación
por un especialista



Descubre más
sobre Simon SM34

simon
LIGHT UP EMOTIONS

www.simonelectric.com



CONECTIVIDAD PUESTOS DE TRABAJO		ILUMINACIÓN INTERIOR	
SIMON 400		SISTEMAS DE ILUMINACIÓN	
Kits	90	Simon Slim&Drop	134
Tomas de conexión individual	93	Simon 860	136
Placas	93	Simon 810	138
SIMON 500 CIMA		DOWNLIGHTS	
Kits	94	Simon ARCH	141
Bases eléctricas	96	Simon HOLE	142
Protección y Placas	97	Simon 703	143
Cajas de pared	99	Simon 704	144
Cajas de suelo	100	Simon 800	144
Registros	101	Simon 725	145
Torretas	102	Simon 640	145
Minicolumnas	102	PROYECTORES	
Columnas	102	Simon 640 Suspendida	146
Envolvertes Metálicos	103	Simon 650	146
SIMON K45		Simon Point	147
Teleblock	103	Simon 615	148
Ofiblock Plus	104	Simon 629	148
Ofiblock Compact	105	Simon 740	149
Ofiblock Line	105	CARRIL	
Cajas de Superficie y Empotrar	107	Simon 899 Monofásico / trifásico	149
Cajas de Suelo Estancas IP66	107	PARED - TECHO	
Cajas de Suelo Simon K45 Profundidad reducida	107	Simon MOOD	151
Minicolumna	108	Simon SLIM	152
Columnas	108	Simon LOOP	152
Envolvertes Metálicos Simon K45	109	Simon 707	152
Mecanismos, interruptores, bases de enchufe, bases eléctricas y protección	107	Simon 712	152
Placas	111	Simon 717	153
SIMON CANALIZACIÓN		Simon 719	153
Minicanal de PVC y PVC libre de halógenos (LSZH)	116	TECHOS MODULARES	
Minicanal de aluminio	116	Simon 720	154
Canal pasacables de PVC	117	Simon 726	155
Canal pasacables de aluminio	118	Simon 729	155
Canal Cablomag de PVC K45 - Clipaje directo -	119	INDUSTRIALES	
Canal Cablomag de aluminio K45 - Clipaje directo -	120	Simon 816	156
Canal de PVC K45 - Clipaje directo -	120	Simon 716	156
Canal de aluminio K45 - Clipaje directo -	122	Simon 780	157
Sistema DCS en interiores - Canal de suelo-	123		
Organizador cableado	124		
SIMON CABLEADO ESTRUCTURADO			
Electroblock	124		
Voz, Datos y Multimedia	125		
SIMON CABLEADO ELÉCTRICO			
Sistema conexión rápida	126		
Cajas distribuidoras	127		
Organizador de cableado	127		

RELACIÓN NUMÉRICA DE ARTÍCULOS

ÍNDICE GENERAL - RELACIÓN NUMÉRICA POR ARTÍCULO

ARTÍCULO	PRECIO €	PIEZAS CAJA	PÁGINA	ARTÍCULO	PRECIO €	PIEZAS CAJA	PÁGINA	ARTÍCULO	PRECIO €	PIEZAS CAJA	PÁGINA	ARTÍCULO	PRECIO €	PIEZAS CAJA	PÁGINA
00160-31	1,40	50	87	0640141-000	1278,62	1	86	0660142-100	1395,00	1	87	10000008-138	15,14	1	60
00165-31	2,39	30	87	0640141-100	1432,67	1	86	0660211-000	2110,00	1	87	10000008-230	16,48	1	60
00502-35	2,66	25	87	0640142-000	1401,86	1	86	0660212-000	2280,00	1	87	10000008-238	16,48	1	60
00531-32	2,66	25	87	0640142-100	1555,91	1	86	0660231-000	1730,00	1	86	10000010-130	10,78	1	60
00579-31	2,52	20	87	0640321-000	1735,63	1	86	0660231-100	1970,00	1	86	10000010-138	10,78	1	60
00579-32	2,56	20	87	0640341-000	1535,37	1	86	0660232-000	1900,00	1	87	10000010-230	11,46	1	60
00588-31	2,25	20	87	0640341-100	1689,42	1	86	0660232-100	2140,00	1	87	10000010-238	11,46	1	60
00588-32	2,24	20	88	0641121-000	1682,23	1	86	0660321-000	1650,00	1	87	10000017-130	11,70	1	60
00590-31	5,16	10	88	0641121-100	1836,28	1	86	0660341-000	1440,00	1	86	10000017-138	11,70	1	60
04900-31	7,10	10	88	0641122-000	1805,47	1	86	0660341-100	1560,00	1	87	10000017-230	12,43	1	60
05070-39	303,31	1	88	0641122-100	1959,52	1	86	0690000-003	28,00	1	86	10000017-238	12,43	1	60
05073-39	43,05	1	88	0641141-000	1481,96	1	86	0690000-004	64,00	1	86	10000037-130	15,72	1	60
05505-30	14,94	1	88	0641141-100	1636,01	1	86	0691100-000	328,40	1	86	10000037-138	15,72	1	60
05505-38	14,94	1	88	0641142-000	1605,20	1	86	0691200-000	328,40	1	86	10000037-230	16,72	1	60
05562-39	41,12	1	88	0641142-100	1759,25	1	86	0691300-000	328,40	1	86	10000037-238	16,72	1	60
05563-30	44,66	1	88	0641321-000	1938,98	1	86	0692100-000	607,75	1	86	10000040-130	15,36	1	60
05705-39	4,55	10	88	0641341-000	1738,71	1	86	0692200-000	607,75	1	86	10000040-138	15,36	1	60
0602102-039	344,88	1	85	0641341-100	1892,76	1	86	0692300-000	607,75	1	86	10000040-230	16,35	1	60
0602142-039	520,05	1	85	0650021-000	738,60	1	86	0692600-000	647,55	1	86	10000040-238	16,35	1	60
0602212-039	684,28	1	85	0650021-100	865,00	1	86	0692M00-000	647,55	1	86	10000041-130	15,11	1	60
0620211-100	4196,14	1	85	0650022-000	797,00	1	86	0693010-000	521,90	1	86	10000041-138	15,11	1	60
0620212-100	4612,26	1	85	0650022-200	943,85	1	86	0693020-000	561,15	1	86	10000041-230	16,05	1	60
0620213-100	4719,89	1	85	0650041-000	708,95	1	86	0693030-000	130,35	1	86	10000041-238	16,05	1	60
0620231-100	3735,73	1	85	0650041-100	809,95	1	86	0693040-000	396,00	1	86	10000042-130	15,84	1	60
0620232-100	4158,05	1	85	0650042-000	722,55	1	86	0693050-000	474,50	1	86	10000042-138	15,84	1	60
0620233-100	4226,23	1	85	0650042-100	838,05	1	86	0693060-000	392,80	1	86	10000047-130	15,36	1	60
0621211-100	4412,66	1	85	0650042-300	920,20	1	86	0693070-000	471,40	1	86	10000047-138	15,36	1	60
0621211-300	4885,10	1	85	0650042-400	995,20	1	86	0694002-000	3030,15	1	86	10000047-230	16,35	1	60
0621212-100	4825,87	1	85	0650141-000	842,80	1	86	0695000-010	56,50	1	86	10000047-238	16,35	1	60
0621213-100	4922,98	1	85	0650141-100	968,05	1	86	0695000-020	82,20	1	86	10000049-130	19,95	1	60
0621231-100	3952,26	1	85	0650142-000	869,90	1	86	0695000-030	54,45	1	86	10000049-138	19,95	1	60
0621231-300	4424,70	1	85	0650142-100	996,20	1	86	0695000-040	170,30	1	86	10000049-230	21,26	1	60
0621232-100	4371,66	1	85	0650142-300	1052,05	1	86	0695000-050	54,45	1	86	10000049-238	21,26	1	60
0621233-100	4468,76	1	85	0650221-000	995,45	1	86	0695000-060	170,30	1	86	10000050-130	19,95	1	60
0630211-100	3683,34	1	85	0650222-000	997,95	1	86	0696000-130	216,55	1	86	10000050-138	19,95	1	60
0630212-100	4155,89	1	85	0651021-000	819,50	1	86	0697000-085	211,25	1	86	10000050-230	21,26	1	60
0630213-100	4367,07	1	85	0651021-100	944,85	1	86	0697000-095	268,25	1	86	10000050-238	21,26	1	60
0630231-100	3229,12	1	85	0651022-000	847,30	1	86	0697000-105	274,90	1	86	10000051-130	11,05	1	60
0630232-100	3701,68	1	85	0651022-200	996,10	1	86	0697000-115	351,90	1	86	10000051-138	11,05	1	60
0630233-100	3860,44	1	85	0651041-000	764,45	1	86	0697000-125	243,90	1	86	10000051-230	11,76	1	60
0631211-100	3896,95	1	85	0651041-100	894,70	1	86	07068-31	15,55	5	87	10000051-238	11,76	1	60
0631211-300	4363,03	1	85	0651042-000	793,90	1	86	10000001-039	10,82	5	60	10000053-130	11,71	1	60
0631212-100	4369,51	1	85	0651042-100	920,20	1	86	10000002-039	16,43	5	60	10000053-138	11,71	1	60
0631213-100	4466,61	1	85	0651042-300	977,90	1	86	10000005-130	11,63	1	60	10000053-230	12,45	1	60
0631231-100	3442,74	1	85	0651042-400	1051,05	1	86	10000005-138	11,63	1	60	10000053-238	12,45	1	60
0631231-300	3908,82	1	85	0660121-000	1400,00	1	87	10000005-230	12,37	1	60	10000068-130	15,36	1	60
0631232-100	3915,29	1	85	0660121-100	1520,00	1	87	10000005-238	12,37	1	60	10000068-138	15,36	1	60
0631233-100	4012,40	1	85	0660122-000	1485,00	1	87	10000006-130	14,82	1	60	10000068-230	16,35	1	60
0640121-000	1478,88	1	86	0660122-100	1605,00	1	87	10000006-138	14,82	1	60	10000068-238	16,35	1	60
0640121-100	1632,93	1	86	0660141-000	1190,00	1	86	10000006-230	15,75	1	60	10000072-130	15,29	1	60
0640122-000	1602,12	1	86	0660141-100	1310,00	1	86	10000006-238	15,75	1	60	10000072-138	15,29	1	60
0640122-100	1756,17	1	86	0660142-000	1275,00	1	87	10000008-130	15,14	1	60	10000072-230	16,26	1	60

ARTÍCULO	PRECIO €	PIEZAS CAJA	PÁGINA	ARTÍCULO	PRECIO €	PIEZAS CAJA	PÁGINA	ARTÍCULO	PRECIO €	PIEZAS CAJA	PÁGINA	ARTÍCULO	PRECIO €	PIEZAS CAJA	PÁGINA
10000072-238	16,26	1	60	10000467-039	17,29	5	60	10001060-138	12,93	1	61	10001432-039	66,10	1	60
10000078-130	15,76	1	60	10000468-039	17,29	5	60	10001060-230	14,43	1	61	10001458-039	68,07	1	60
10000078-138	15,76	1	60	10000470-039	39,18	5	60	10001060-238	14,43	1	61	10001610-130	13,09	1	56
10000078-230	16,76	1	60	10000471-039	39,18	5	60	10001080-130	55,02	1	61	10001610-138	13,09	1	56
10000078-238	16,76	1	60	10000472-039	39,18	5	60	10001080-138	55,02	1	61	10001610-230	13,66	1	56
10000091-130	14,18	1	60	10000526-039	23,07	5	60	10001080-230	60,82	1	61	10001610-238	13,66	1	56
10000091-138	14,18	1	60	10000544-039	23,40	5	60	10001080-238	60,82	1	61	10001620-130	19,87	1	56
10000091-230	15,09	1	60	10000546-230	38,56	1	60	10001090-130	13,59	1	61	10001620-138	19,87	1	56
10000091-238	15,09	1	60	10000546-238	38,56	1	60	10001090-138	13,59	1	61	10001620-230	20,71	1	56
10000101-039	7,62	10	60	10000550-039	25,37	5	60	10001090-230	14,46	1	61	10001620-238	20,71	1	56
10000110-130	11,60	1	60	10000560-039	32,18	1	60	10001090-238	14,46	1	61	10001630-130	27,87	1	56
10000110-138	11,60	1	60	10000561-039	25,66	1	60	10001091-130	11,41	1	61	10001630-138	27,87	1	56
10000110-230	12,34	1	60	10000562-039	35,38	1	60	10001091-138	11,41	1	61	10001630-230	27,80	1	56
10000110-238	12,34	1	60	10000563-039	44,54	1	60	10001091-230	12,14	1	61	10001630-238	27,80	1	56
10000133-039	15,24	10	60	10000564-039	46,50	1	60	10001091-238	12,14	1	61	10001640-130	34,00	1	56
10000133-130	10,78	1	61	10000565-039	25,66	1	60	10001093-130	11,41	1	61	10001640-138	34,00	1	56
10000133-138	10,78	1	61	10000566-039	97,57	1	60	10001093-138	11,41	1	61	10001640-230	34,52	1	56
10000133-230	11,46	1	61	10000567-039	93,35	1	60	10001093-230	12,14	1	61	10001640-238	34,52	1	56
10000133-238	11,46	1	61	10000610-130	10,63	1	56	10001093-238	12,14	1	61	10001800-130	8,41	1	61
10000137-130	21,71	1	61	10000610-138	10,63	1	56	10001094-130	13,01	1	61	10001800-138	8,41	1	61
10000137-138	21,71	1	61	10000610-230	11,09	1	56	10001094-138	13,01	1	61	10001800-230	8,96	1	61
10000137-230	23,10	1	61	10000610-238	11,09	1	56	10001094-230	13,83	1	61	10001800-238	8,96	1	61
10000137-238	23,10	1	61	10000620-130	14,78	1	56	10001094-238	13,83	1	61	10001910-039	4,61	5	56
10000150-039	7,87	10	60	10000620-138	14,78	1	56	10001095-130	13,59	1	61	10001920-039	5,72	5	56
10000168-130	19,95	1	61	10000620-230	15,42	1	56	10001095-138	13,59	1	61	10002020-130	92,79	1	62
10000168-138	19,95	1	61	10000620-238	15,42	1	56	10001095-230	14,46	1	61	10002020-138	92,79	1	62
10000168-230	21,26	1	61	10000630-130	19,31	1	56	10001095-238	14,46	1	61	10002020-230	100,58	1	62
10000168-238	21,26	1	61	10000630-138	19,31	1	56	10001096-130	13,66	1	61	10002020-238	100,58	1	62
10000169-130 ^h	19,95	1	61	10000630-230	19,44	1	56	10001096-138	13,66	1	61	10002021-130	90,57	1	62
10000169-138 ^h	19,95	1	61	10000630-238	19,44	1	56	10001096-230	14,53	1	61	10002021-138	90,57	1	62
10000169-230 ^h	21,26	1	61	10000640-130	23,45	1	56	10001096-238	14,53	1	61	10002021-230	98,18	1	62
10000169-238 ^h	21,26	1	61	10000640-138	23,45	1	56	10001097-130	13,80	1	61	10002021-238	98,18	1	62
10000201-039	8,97	10	60	10000640-230	22,95	1	56	10001097-138	13,80	1	61	10002034-130	85,32	1	62
10000211-039	9,74	10	60	10000640-238	22,95	1	56	10001097-230	14,66	1	61	10002034-138	85,32	1	62
10000251-039	17,83	10	60	10000800-130	4,21	1	61	10001097-238	14,66	1	61	10002034-230	92,49	1	62
10000296-039 ^h	51,56	1	60	10000800-138	4,21	1	61	10001150-039	50,58	1	60	10002034-238	92,49	1	62
10000306-039	93,07	1	62	10000800-230	4,48	1	61	10001196-130	14,65	1	61	10002035-130	95,82	1	62
10000314-039	112,34	1	62	10000800-238	4,48	1	61	10001196-138	14,65	1	61	10002035-138	95,82	1	62
10000316-039	144,56	1	62	10000801-039	10,15	5	60	10001196-230	15,58	1	61	10002035-230	103,86	1	62
10000317-039	133,83	1	62	10000810-130	217,05	1	62	10001196-238	15,58	1	61	10002035-238	103,86	1	62
10000321-039	96,15	1	62	10000810-138	217,05	1	62	10001197-130 ^h	13,01	1	61	10002036-130	107,59	1	62
10000322-039	90,51	1	62	10000811-130	235,54	1	62	10001197-138	13,01	1	61	10002036-138	107,59	1	62
10000380-039	42,69	1	60	10000811-138	235,54	1	62	10001197-230	13,83	1	61	10002036-230	115,53	1	62
10000381-039	51,30	1	60	10000910-039	2,26	5	56	10001197-238	13,83	1	61	10002036-238	115,53	1	62
10000382-039 ^h	39,52	1	60	10000920-039	2,99	5	56	10001296-130 ^h	13,06	1	61	10002037-130	107,59	1	62
10000431-039	8,91	10	60	10000930-039	3,97	5	56	10001296-138 ^h	13,06	1	61	10002037-138	107,59	1	62
10000432-039	8,61	10	60	10000940-039	5,58	1	56	10001296-230 ^h	14,15	1	61	10002037-230	115,53	1	62
10000439-130	10,27	5	60	10001020-130	45,69	1	61	10001296-238 ^h	14,15	1	61	10002037-238	115,53	1	62
10000439-138	10,27	5	60	10001020-138	45,69	1	61	10001343-039	118,89	1	60	10002041-130	99,89	1	62
10000458-039	10,27	10	60	10001020-230	50,03	1	61	10001344-039	118,89	1	60	10002041-138	99,89	1	62
10000465-039	19,05	1	60	10001020-238	50,03	1	61	10001358-039	84,59	1	62	10002041-230	108,29	1	62
10000466-039	17,29	5	60	10001060-130	12,93	1	61	10001359-039	148,92	1	62	10002041-238	108,29	1	62

RELACIÓN NUMÉRICA DE ARTÍCULOS

ÍNDICE GENERAL - RELACIÓN NUMÉRICA POR ARTÍCULO

ARTÍCULO	PRECIO €	PIEZAS CAJA	PÁGINA	ARTÍCULO	PRECIO €	PIEZAS CAJA	PÁGINA	ARTÍCULO	PRECIO €	PIEZAS CAJA	PÁGINA	ARTÍCULO	PRECIO €	PIEZAS CAJA	PÁGINA
10002051-130	15,51	1	61	10010106-039	25,62	1	56	10020101-230	25,11	1	56	10020201-230	43,61	1	57
10002051-138	15,51	1	61	10010108-039	104,23	1	61	10020101-238	25,11	1	56	10020201-238	43,61	1	57
10002051-230	16,48	1	61	10010109-039	68,80	1	57	10020103-130	32,16	1	56	10020202-130	44,95	1	57, 59
10002051-238	16,48	1	61	10010111-039	43,82	1	57	10020103-138	32,16	1	56	10020202-138	44,95	1	57, 59
10002080-130	90,56	1	62	10010112-039	92,77	1	61	10020103-230	33,99	1	56	10020202-230	47,51	1	57, 59
10002080-138	90,56	1	62	10010113-039	93,49	1	57, 61	10020103-238	33,99	1	56	10020202-238	47,51	1	57, 59
10002080-230	98,17	1	62	10010115-039	86,40	1	57, 61	10020105-130	25,72	1	56	10020203-130	44,83	1	57
10002080-238	98,17	1	62	10010117-039	188,36	1	61	10020105-138	25,72	1	56	10020203-138	44,83	1	57
10002081-130	90,57	1	62	10010137-039 N	72,71	1	57	10020105-230	27,14	1	56	10020203-230	47,39	1	57
10002081-138	90,57	1	62	10010201-039	20,85	1	57, 59	10020105-238	27,14	1	56	10020203-238	47,39	1	57
10002081-230	98,18	1	62	10010202-039	20,06	1	57, 59	10020106-130	24,71	1	56	10020204-130	51,39	1	57, 59
10002081-238	98,18	1	62	10010203-039	20,45	1	57	10020106-138	24,71	1	56	10020204-138	51,39	1	57, 59
10002082-130	123,24	1	62	10010204-039	29,38	1	57, 59	10020106-230	26,00	1	56	10020204-230	54,34	1	57, 59
10002082-138	123,24	1	62	10010205-039	57,45	1	57	10020106-238	26,00	1	56	10020204-238	54,34	1	57, 59
10002082-230	128,38	1	62	10010206-039	62,45	1	57	10020109-130	31,24	1	56	10020205-130	43,51	1	57
10002082-238	128,38	1	62	10010207-039	72,02	1	57	10020109-138	31,24	1	56	10020205-138	43,51	1	57
10002083-130	123,24	1	62	10010208-039	50,68	1	57	10020109-230	33,00	1	56	10020205-230	45,99	1	57
10002083-138	123,24	1	62	10010209-039	151,43	1	57	10020109-238	33,00	1	56	10020205-238	45,99	1	57
10002083-230	133,51	1	62	10010210-039	93,12	1	57	10020111-130	25,43	1	57	10020206-130	56,85	1	57
10002083-238	133,51	1	62	10010211-039	133,27	1	57	10020111-138	25,43	1	57	10020206-138	56,85	1	57
10002135-130	165,25	1	62	10010212-039	81,19	1	58	10020111-230	26,83	1	57	10020206-230	60,15	1	57
10002135-138	165,25	1	62	10010214-039	29,78	1	59	10020111-238	26,83	1	57	10020206-238	60,15	1	57
10002135-230	180,13	1	62	10010216-039	52,17	1	59	10020112-130	98,65	1	61	10020207-130	56,85	1	57
10002135-238	180,13	1	62	10010238-039	61,16	1	58	10020112-138	98,65	1	61	10020207-138	56,85	1	57
10002181-130	170,69	1	62	10010248-039 N	143,84	1	58	10020112-230	106,41	1	61	10020207-230	60,15	1	57
10002181-138	170,69	1	62	10010249-039 N	93,53	1	58	10020112-238	106,41	1	61	10020207-238	60,15	1	57
10002181-230	186,04	1	62	10010254-039 N	58,91	1	58	10020113-130	58,73	1	57	10020208-130	45,14	1	57
10002181-238	186,04	1	62	10010255-039 N	67,94	1	58	10020113-138	58,73	1	57	10020208-138	45,14	1	57
10002214-039	65,60	1	55, 62	10010256-039 N	142,85	1	58	10020113-230	63,63	1	57	10020208-230	47,69	1	57
10002343-039	81,90	1	55, 62	10010258-039 N	87,84	1	58	10020113-238	63,63	1	57	10020208-238	47,69	1	57
10002432-039	101,98	1	62	10010301-039	30,77	1	58	10020114-130	105,92	1	61	10020209-130	92,94	1	57
10002544-039	41,60	5	60	10010302-039	29,59	1	58, 59	10020114-138	105,92	1	61	10020209-138	92,94	1	57
10002620-130	19,87	1	56	10010303-039	60,20	1	58	10020114-230	114,28	1	61	10020209-230	99,99	1	57
10002620-138	19,87	1	56	10010304-039	96,19	1	58	10020114-238	114,28	1	61	10020209-238	99,99	1	57
10002620-230	20,71	1	56	10010305-039	101,54	1	58	10020115-130	68,29	1	57	10020210-130	46,31	1	57
10002620-238	20,71	1	56	10010306-039	153,38	1	58	10020115-138	68,29	1	57	10020210-138	46,31	1	57
10002621-130	15,67	1	56	10010307-039	162,43	1	58	10020115-230	74,65	1	57	10020210-230	48,92	1	57
10002621-138	15,67	1	56	10010308-039	67,18	1	58	10020115-238	74,65	1	57	10020210-238	48,92	1	57
10002621-230	16,27	1	56	10010309-039	103,40	1	58	10020116-130	103,73	1	61	10020211-130	55,60	1	57
10002621-238	16,27	1	56	10010310-039	38,91	1	59, 60	10020116-138	103,73	1	61	10020211-138	55,60	1	57
10002801-039	9,86	5	60	10010333-039	151,13	1	59	10020116-230	111,88	1	61	10020211-230	66,30	1	57
10002860-039	87,40	1	55, 62	10010334-039	159,62	1	59	10020116-238	111,88	1	61	10020211-238	66,30	1	57
10002861-039	98,30	1	55, 62	10010335-039	70,30	1	59	10020117-130	192,39	1	61	10020212-130	58,44	1	58
10002862-039	109,20	1	55, 62	10010336-039 N	97,54	1	59	10020117-138	192,39	1	61	10020212-138	58,44	1	58
10002880-039	65,60	1	55, 62	10010401-039	39,70	1	59	10020117-230	208,14	1	61	10020212-230	61,83	1	58
10002890-039	295,30	1	55, 62	10010402-039	106,32	1	59	10020117-238	208,14	1	61	10020212-238	61,83	1	58
10002892-039	65,60	1	55, 62	10010403-039	150,08	1	59	10020137-130 N	30,36	1	57	10020213-130	41,40	1	59
10010101-039	11,17	1	56	10010411-039 N	141,58	1	59	10020137-138 N	30,36	1	57	10020213-138	41,40	1	59
10010102-039	20,05	1	56	10011432-039	70,38	5	60	10020137-230 N	32,07	1	57	10020213-230	43,61	1	59
10010103-039	20,11	1	56	10011458-039	72,48	5	60	10020137-238 N	32,07	1	57	10020213-238	43,61	1	59
10010104-039	37,86	1	56	10020101-130	23,85	1	56	10020201-130	41,40	1	57	10020215-130	51,27	1	59
10010105-039	10,78	1	56	10020101-138	23,85	1	56	10020201-138	41,40	1	57	10020215-138	51,27	1	59

ARTÍCULO	PRECIO €	PIEZAS CAJA	PÁGINA	ARTÍCULO	PRECIO €	PIEZAS CAJA	PÁGINA	ARTÍCULO	PRECIO €	PIEZAS CAJA	PÁGINA	ARTÍCULO	PRECIO €	PIEZAS CAJA	PÁGINA
10020215-230	54,21	1	59	10020302-230	68,32	1	58, 59	10020403-230	92,22	1	59	20000053-090	4,71	5	51
10020215-238	54,21	1	59	10020302-238	68,32	1	58, 59	10020403-238	92,22	1	59	20000053-098	5,37	5	51
10020216-130	51,50	1	59	10020303-130	64,76	1	58	10020411-130 ^N	82,25	1	59	20000053-190 ^N	5,37	5	51
10020216-138	51,50	1	59	10020303-138	64,76	1	58	10020411-138 ^N	82,25	1	59	20000087-090	7,79	10	51
10020216-230	54,45	1	59	10020303-230	68,50	1	58	10020411-230 ^N	87,00	1	59	20000087-093	9,77	10	51
10020216-238	54,45	1	59	10020303-238	68,50	1	58	10020411-238 ^N	87,00	1	59	20000087-098	8,89	10	51
10020218-130	58,44	1	59	10020304-130	63,26	1	58	10021108-130	110,85	1	61	20000087-190 ^N	8,89	10	51
10020218-138	58,44	1	59	10020304-138	63,26	1	58	10021108-138	110,85	1	61	20000088-090	7,96	10	51
10020218-230	61,83	1	59	10020304-230	66,90	1	58	10021108-230	119,75	1	61	20000088-093	11,44	10	51
10020218-238	61,83	1	59	10020304-238	66,90	1	58	10021108-238	119,75	1	61	20000088-098	10,41	10	51
10020238-130	41,60	1	58	10020305-130	61,58	1	58	10021209-130	92,94	1	57	20000088-190 ^N	10,41	10	51
10020238-138	41,60	1	58	10020305-138	61,58	1	58	10021209-138	92,94	1	57	20000090-090	23,49	1	52
10020238-230	43,99	1	58	10020305-230	65,12	1	58	10021209-230	99,99	1	57	20000090-091	36,96	1	52
10020238-238	53,89	1	58	10020305-238	65,12	1	58	10021209-238	99,99	1	57	20000090-093	29,04	1	52
10020248-130 ^N	54,03	1	58	10020306-130	113,01	1	58	10032108-130	443,05	1	62	20000090-094	36,96	1	52
10020248-138 ^N	54,03	1	58	10020306-138	113,01	1	58	10032108-138	443,05	1	62	20000090-095	36,96	1	52
10020248-230 ^N	64,42	1	58	10020306-230	122,09	1	58	10032108-230	465,26	1	62	20000090-096	36,96	1	52
10020248-238 ^N	64,42	1	58	10020306-238	122,09	1	58	10032108-238	465,26	1	62	20000090-097	36,96	1	52
10020249-130 ^N	56,79	1	58	10020308-130	63,14	1	58	10300-31	166,54	1	88	20000090-098	26,40	1	52
10020249-138 ^N	56,79	1	58	10020308-138	63,14	1	58	10301-31	96,52	1	88	20000090-190 ^N	26,40	1	52
10020249-230 ^N	60,08	1	58	10020308-230	66,80	1	58	10302-31	103,14	1	88	20000091-090	41,07	1	52
10020249-238 ^N	60,08	1	58	10020308-238	66,80	1	58	10303-31	211,26	1	88	20000091-098	46,10	1	52
10020250-130 ^N	50,04	1	59	10020309-130	67,11	1	58	10403-31	8,94	10	87	20000091-190 ^N	46,10	1	52
10020250-138 ^N	50,04	1	59	10020309-138	67,11	1	58	10404-31	10,71	10	87	20000094-090	70,35	1	52
10020250-230 ^N	52,91	1	59	10020309-230	70,97	1	58	10405-31	14,24	10	87	20000094-091	83,24	1	52
10020250-238 ^N	52,91	1	59	10020309-238	70,97	1	58	10431-31	2,05	30	87	20000094-093	79,27	1	52
10020254-130 ^N	53,63	1	58	10020310-130	71,02	1	59, 60	10436-31	21,35	5	87	20000094-094	83,24	1	52
10020254-138 ^N	53,63	1	58	10020310-138	71,02	1	59, 60	10437-31	17,08	5	87	20000094-095	83,24	1	52
10020254-230 ^N	56,74	1	58	10020310-230	75,16	1	59, 60	10442-31	2,66	20	87	20000094-096	83,24	1	52
10020254-238 ^N	56,74	1	58	10020310-238	75,16	1	59, 60	10451-31	2,52	30	87	20000094-097	83,24	1	52
10020255-130 ^N	53,63	1	58	10020333-130	60,40	1	59	10457-31	13,83	10	87	20000094-098	75,49	1	52
10020255-138 ^N	53,63	1	58	10020333-138	60,40	1	59	10462-31	12,43	10	87	20000094-190 ^N	75,49	1	52
10020255-230 ^N	56,74	1	58	10020333-230	63,88	1	59	10463-31	15,94	10	87	20000095-090	97,71	1	52
10020255-238 ^N	56,74	1	58	10020333-238	63,88	1	59	10464-31	20,90	10	87	20000095-091	115,60	1	52
10020256-130 ^N	87,67	1	58	10020335-130	108,09	1	59	10465-31	24,51	5	87	20000095-093	110,09	1	52
10020256-138 ^N	87,67	1	58	10020335-138	108,09	1	59	10475-31	33,25	5	87	20000095-094	115,60	1	52
10020256-230 ^N	94,33	1	58	10020335-230	116,77	1	59	10490-31	1,71	10	88	20000095-095	115,60	1	52
10020256-238 ^N	94,33	1	58	10020335-238	116,77	1	59	10498-31	3,20	10	88	20000095-096	115,60	1	52
10020257-130 ^N	87,67	1	58	10020336-130 ^N	63,31	1	59	10499-31	4,71	10	88	20000095-097	115,60	1	52
10020257-138 ^N	87,67	1	58	10020336-138 ^N	63,31	1	59	10502-31	5,85	25	88	20000095-098	104,85	1	52
10020257-230 ^N	94,33	1	58	10020336-230 ^N	66,95	1	59	10517-31	3,86	10	88	20000095-190 ^N	104,85	1	52
10020257-238 ^N	94,33	1	58	10020336-238 ^N	66,95	1	59	10517-39	1,72	10	88	20000096-090	51,22	1	51
10020258-130 ^N	43,68	1	58	10020401-130	83,80	1	59	10531-32	5,08	25	88	20000096-091	74,70	1	51
10020258-138 ^N	43,68	1	58	10020401-138	83,80	1	59	10559-32	0,84	20	88	20000096-093	63,22	1	51
10020258-230 ^N	46,15	1	58	10020401-230	88,67	1	59	10562-31	18,71	10	88	20000096-094	74,70	1	51
10020258-238 ^N	46,15	1	58	10020401-238	88,67	1	59	10579-32	1,47	50	88	20000096-095	74,70	1	51
10020301-130	60,16	1	58	10020402-130	82,48	1	59	10611-31	1,08	20	88	20000096-096	74,70	1	51
10020301-138	60,16	1	58	10020402-138	82,48	1	59	10613-31	1,10	20	88	20000096-097	74,70	1	51
10020301-230	63,42	1	58	10020402-230	87,26	1	59	10825-31	1,97	10	88	20000096-098	57,47	1	51
10020301-238	63,42	1	58	10020402-238	87,26	1	59	10826-31	3,42	10	88	20000101-090	4,73	10	49
10020302-130	64,59	1	58, 59	10020403-130	87,19	1	59	10827-31	4,37	10	88	20000101-091	9,75	5	49
10020302-138	64,59	1	58, 59	10020403-138	87,19	1	59	10828-31	10,78	10	88	20000101-093	7,66	5	49

RELACIÓN NUMÉRICA DE ARTÍCULOS

ÍNDICE GENERAL - RELACIÓN NUMÉRICA POR ARTÍCULO

ARTÍCULO	PRECIO €	PIEZAS CAJA	PÁGINA	ARTÍCULO	PRECIO €	PIEZAS CAJA	PÁGINA	ARTÍCULO	PRECIO €	PIEZAS CAJA	PÁGINA	ARTÍCULO	PRECIO €	PIEZAS CAJA	PÁGINA
20000101-094	9,75	5	49	20000187-091	30,84	5	52	20000251-190 ^N	19,13	20	49	20000434-091	19,18	10	50
20000101-095	9,75	5	49	20000187-093	24,24	5	52	20000254-090	22,40	5	49	20000434-093	13,17	10	50
20000101-096	9,75	5	49	20000187-094	30,84	5	52	20000254-098	31,68	5	49	20000434-094	19,18	10	50
20000101-097	9,75	5	49	20000187-095	30,84	5	52	20000254-190 ^N	31,68	10	49	20000434-095	19,18	10	50
20000101-098	6,85	10	49	20000187-096	30,84	5	52	20000296-090 ^N	55,88	1	51	20000434-096	19,18	10	50
20000101-190 ^N	6,85	20	49	20000187-097	30,84	5	52	20000296-091 ^N	77,92	1	51	20000434-097	19,18	10	50
20000102-090*	13,36	5	49	20000187-098	22,03	10	52	20000296-093 ^N	65,93	1	51	20000434-098	12,61	10	50
20000102-098	19,03	5	49	20000187-190 ^N	22,03	10	52	20000296-094 ^N	77,92	1	51	20000434-190 ^N	12,61	10	50
20000102-190 ^N	19,03	10	49	20000188-090	34,31	10	52	20000296-095 ^N	77,92	1	51	20000439-090 ^N	12,71	10	50
20000111-090*	11,17	5	49	20000188-091	50,85	5	52	20000296-096 ^N	77,92	1	51	20000439-098 ^N	15,26	10	50
20000111-098	15,89	5	49	20000188-093	39,98	5	52	20000296-097 ^N	77,92	1	51	20000455-090	9,21	10	51
20000111-190 ^N	15,89	10	49	20000188-094	50,85	5	52	20000296-098 ^N	59,94	1	51	20000455-091	21,53	10	51
20000134-090*	28,60	5	49	20000188-095	50,85	5	52	20000296-190 ^N	59,94	1	51	20000455-093	14,79	10	51
20000134-098	40,71	5	49	20000188-096	50,85	5	52	20000313-090	73,29	1	52	20000455-094	21,53	10	51
20000134-190 ^N	40,71	10	49	20000188-097	50,85	5	52	20000313-091	83,18	1	52	20000455-095	21,53	10	51
20000150-090	6,66	10	49	20000188-098	36,34	10	52	20000313-093	76,65	1	52	20000455-096	21,53	10	51
20000150-091	12,78	5	49	20000188-190 ^N	36,34	10	52	20000313-094	83,18	1	52	20000455-097	21,53	10	51
20000150-093	10,04	5	49	20000196-090	55,88	1	51	20000313-095	83,18	1	52	20000455-098	14,16	10	51
20000150-094	12,78	5	49	20000196-091	77,92	1	51	20000313-096	83,18	1	52	20000455-190 ^N	14,16	10	51
20000150-095	12,78	5	49	20000196-093	65,93	1	51	20000313-097	83,18	1	52	20000458-090	6,46	10	51
20000150-096	12,78	5	49	20000196-094	77,92	1	51	20000313-098	74,34	1	52	20000458-093	9,73	10	51
20000150-097	12,78	5	49	20000196-095	77,92	1	51	20000313-190 ^N	74,34	1	52	20000458-098	9,28	10	51
20000150-098	9,13	10	49	20000196-096	77,92	1	51	20000333-090	25,87	5	52	20000458-190 ^N	9,28	10	51
20000150-190 ^N	9,13	20	49	20000196-097	77,92	1	51	20000333-091	39,47	5	52	20000472-090	5,90	10	50
20000151-090	6,86	10	49	20000196-098	59,94	1	51	20000333-093	30,99	5	52	20000472-098	8,48	10	50
20000151-091	13,19	5	49	20000196-190 ^N	59,94	1	51	20000333-094	39,47	5	52	20000472-190 ^N	8,48	10	50
20000151-093	10,39	5	49	20000201-090	5,49	10	49	20000333-095	39,47	5	52	20000486-090	22,13	10	51
20000151-094	13,19	5	49	20000201-091	11,36	5	49	20000333-096	39,47	5	52	20000486-091	35,52	5	51
20000151-095	13,19	5	49	20000201-093	8,93	5	49	20000333-097	39,47	5	52	20000486-093	27,93	5	51
20000151-096	13,19	5	49	20000201-094	11,36	5	49	20000333-098	28,19	5	52	20000486-094	35,52	5	51
20000151-097	13,19	5	49	20000201-095	11,36	5	49	20000333-190 ^N	28,19	5	52	20000486-095	35,52	5	51
20000151-098	9,42	10	49	20000201-096	11,36	5	49	20000382-090 ^N	48,84	1	51	20000486-096	35,52	5	51
20000151-190 ^N	9,42	20	49	20000201-097	11,36	5	49	20000382-091 ^N	71,22	1	51	20000486-097	35,52	5	51
20000152-090	6,86	10	49	20000201-098	8,13	10	49	20000382-093 ^N	60,27	1	51	20000486-098	25,38	10	51
20000152-091	13,19	5	49	20000201-190 ^N	8,13	20	49	20000382-094 ^N	71,22	1	51	20000486-190 ^N	25,38	10	51
20000152-093	10,39	5	49	20000204-090	13,79	10	49	20000382-095 ^N	71,22	1	51	20000487-090	21,77	10	51
20000152-094	13,19	5	49	20000204-091	27,45	5	49	20000382-096 ^N	71,22	1	51	20000487-091	34,95	5	51
20000152-095	13,19	5	49	20000204-093	21,59	5	49	20000382-097 ^N	71,22	1	51	20000487-093	27,45	5	51
20000152-096	13,19	5	49	20000204-094	27,45	5	49	20000382-098 ^N	54,79	1	51	20000487-094	34,95	5	51
20000152-097	13,19	5	49	20000204-095	27,45	5	49	20000431-090	6,25	10	51	20000487-095	34,95	5	51
20000152-098	9,42	10	49	20000204-096	27,45	5	49	20000431-098	9,05	10	51	20000487-096	34,95	5	51
20000152-190 ^N	9,42	20	49	20000204-097	27,45	5	49	20000431-190 ^N	9,05	10	51	20000487-097	34,95	5	51
20000153-090	15,66	10	50	20000204-098	19,61	10	49	20000432-090	5,90	10	50	20000487-098	24,97	10	51
20000153-098	22,28	10	50	20000204-190 ^N	19,61	20	49	20000432-091	12,34	10	50	20000487-190 ^N	24,97	10	51
20000153-190 ^N	22,28	10	50	20000251-090	13,39	10	49	20000432-093	8,89	10	50	20000488-090	21,96	10	51
20000160-090	14,35	5	49	20000251-091	25,72	5	49	20000432-094	12,34	10	50	20000488-091	35,24	5	51
20000160-098	20,41	5	49	20000251-093	20,20	5	49	20000432-095	12,34	10	50	20000488-093	27,70	5	51
20000160-190 ^N	20,41	10	49	20000251-094	25,72	5	49	20000432-096	12,71	10	50	20000488-094	35,24	5	51
20000161-090	13,91	5	49	20000251-095	25,72	5	49	20000432-097	12,34	10	50	20000488-095	35,24	5	51
20000161-098	19,80	5	49	20000251-096	25,72	5	49	20000432-098	8,48	10	50	20000488-096	35,24	5	51
20000161-190 ^N	19,80	10	49	20000251-097	25,72	5	49	20000432-190 ^N	8,48	10	50	20000488-097	35,24	5	51
20000187-090	20,79	10	52	20000251-098	19,13	10	49	20000434-090	8,20	10	50	20000488-098	25,19	10	51

ARTÍCULO	PRECIO €	PIEZAS CAJA	PÁGINA	ARTÍCULO	PRECIO €	PIEZAS CAJA	PÁGINA	ARTÍCULO	PRECIO €	PIEZAS CAJA	PÁGINA	ARTÍCULO	PRECIO €	PIEZAS CAJA	PÁGINA
20000488-190 N	25,19	10	51	20000806-090	25,29	10	53	20001151-095	16,24	10	50	20001333-093	30,99	5	52
20000492-090 N	9,64	10	50	20000806-098	28,17	10	53	20001151-096	16,24	10	50	20001333-094	39,47	5	52
20000492-091 N	13,49	10	50	20000806-190 N	28,17	10	53	20001151-097	16,24	10	50	20001333-095	39,47	5	52
20000492-093 N	11,57	10	50	20000811-090	6,09	10	49	20001151-098	11,61	20	50	20001333-096	39,47	5	52
20000492-094 N	13,49	10	50	20000811-098	7,93	10	49	20001151-190 N	11,61	20	50	20001333-097	39,47	5	52
20000492-095 N	13,49	10	50	20000811-190 N	7,93	10	49	20001152-090	8,81	20	50	20001333-098	28,19	10	52
20000492-096 N	11,57	10	50	20000821-090	10,82	5	49	20001152-091	16,24	10	50	20001333-190 N	28,19	10	52
20000492-097 N	13,49	10	50	20000821-098	14,05	5	49	20001152-093	12,77	10	50	20001432-090 N	61,05	1	51
20000492-098 N	10,60	10	50	20000821-190 N	14,05	5	49	20001152-094	16,24	10	50	20001432-091 N	74,11	1	51
20000492-190 N	10,60	10	50	20000831-090	14,10	5	49	20001152-095	16,24	10	50	20001432-093 N	66,25	1	51
20000526-090	29,99	5	50	20000831-098	18,33	5	49	20001152-096	16,24	10	50	20001432-094 N	74,11	1	51
20000526-091	54,99	1	50	20000831-190 N	18,33	5	49	20001152-097	16,24	10	50	20001432-095 N	74,11	1	51
20000526-093	46,52	1	50	20000910-039	0,90	20	48	20001152-098	11,61	20	50	20001432-096 N	74,11	1	51
20000526-094	54,99	1	50	20000920-039	1,60	10	48	20001152-190 N	11,61	20	50	20001432-097 N	74,11	1	51
20000526-095	54,99	1	50	20000930-039	2,39	5	48	20001160-090	16,03	10	50	20001432-098 N	63,47	1	51
20000526-096	54,99	1	50	20000940-039	3,18	5	48	20001160-098	22,75	10	50	20001432-190 N	63,47	1	51
20000526-097	54,99	1	50	20000950-039	4,73	5	48	20001160-190 N	22,75	10	50	20001800-090	2,49	20	52
20000526-098	42,30	5	50	20000950-090 N	13,49	10	50	20001161-090	15,53	10	50	20001800-091	6,85	5	52
20000526-190 N	42,30	5	50	20000951-090	13,76	1	50	20001161-098	22,06	10	50	20001800-093	5,38	5	52
20000546-090	22,66	5	52	20000951-190 N	19,41	1	50	20001161-190 N	22,06	10	50	20001800-094	6,85	5	52
20000546-098	25,46	5	52	20000952-090	13,76	1	50	20001201-090	5,66	20	49	20001800-095	6,85	5	52
20000546-190 N	25,46	1	52	20000952-190 N	19,41	1	50	20001201-091	14,02	10	49	20001800-096	6,85	5	52
20000550-090	31,75	5	50	20001101-090	4,93	20	49	20001201-093	9,84	10	49	20001800-097	6,85	5	52
20000550-091	58,29	1	50	20001101-091	12,02	10	49	20001201-094	14,02	10	49	20001800-098	4,80	20	52
20000550-093	49,31	1	50	20001101-093	8,85	10	49	20001201-095	14,02	10	49	20001800-190 N	4,80	20	52
20000550-094	58,29	1	50	20001101-094	12,02	10	49	20001201-096	14,02	10	49	21000121-090	91,46	1	54
20000550-095	58,29	1	50	20001101-095	12,02	10	49	20001201-097	14,02	10	49	21000121-091	107,81	1	54
20000550-096	58,29	1	50	20001101-096	12,02	10	49	20001201-098	8,81	20	49	21000121-093	96,40	1	54
20000550-097	58,29	1	50	20001101-097	12,02	10	49	20001201-190 N	8,81	20	49	21000121-094	107,81	1	54
20000550-098	44,84	5	50	20001101-098	7,43	20	49	20001204-090	15,39	20	50	21000121-095	107,81	1	54
20000550-190 N	44,84	5	50	20001101-190 N	7,43	20	49	20001204-091	30,63	10	50	21000121-096	107,81	1	54
20000751-090	5,84	10	48	20001102-090	13,93	10	50	20001204-093	24,07	10	50	21000121-097	107,81	1	54
20000751-098	7,57	10	48	20001102-098	19,81	10	50	20001204-094	30,63	10	50	21000121-098	92,32	1	54
20000751-190 N	7,57	10	48	20001102-190 N	19,81	10	50	20001204-095	30,63	10	50	21000121-190 N	92,32	1	54
20000752-090	10,46	5	48	20001111-090	11,50	10	50	20001204-096	30,63	10	50	21000133-090	87,92	1	54
20000752-098	13,60	5	48	20001111-098	16,38	10	50	20001204-097	30,63	10	50	21000133-091	103,61	1	54
20000752-190 N	13,60	5	48	20001134-090	35,14	10	50	20001204-098	21,88	20	50	21000133-093	92,65	1	54
20000753-090	13,65	5	48	20001134-098	50,02	10	50	20001204-095 N	21,88	20	50	21000133-094	103,61	1	54
20000753-098	17,74	5	48	20001134-190 N	50,02	10	50	20001251-090	15,84	20	49	21000133-095	103,61	1	54
20000753-190 N	17,74	5	48	20001150-090	8,52	20	50	20001251-091	28,67	10	49	21000133-096	103,61	1	54
20000800-090	3,14	10	52	20001150-091	15,75	10	50	20001251-093	22,53	10	49	21000133-097	103,61	1	54
20000800-091	6,65	5	52	20001150-093	12,36	10	50	20001251-094	28,67	10	49	21000133-098	88,72	1	54
20000800-093	5,22	5	52	20001150-094	15,75	10	50	20001251-095	28,67	10	49	21000133-190 N	88,72	1	54
20000800-094	6,65	5	52	20001150-095	15,75	10	50	20001251-096	28,67	10	49	21000201-090	87,92	1	53
20000800-095	6,65	5	52	20001150-096	15,75	10	50	20001251-097	28,67	10	49	21000201-091	103,61	1	53
20000800-096	6,65	5	52	20001150-097	15,75	10	50	20001251-098	20,49	20	49	21000201-093	92,65	1	53
20000800-097	6,65	5	52	20001150-098	11,26	20	50	20001251-190 N	20,49	20	49	21000201-094	103,61	1	53
20000800-098	4,83	10	52	20001150-190 N	11,26	20	50	20001254-090	24,96	10	50	21000201-095	103,61	1	53
20000800-190 N	4,83	10	52	20001151-090	8,81	20	50	20001254-098	35,29	10	50	21000201-096	103,61	1	53
20000801-090	6,38	10	52	20001151-091	16,24	10	50	20001254-190 N	35,29	10	50	21000201-097	103,61	1	53
20000801-098	8,10	10	52	20001151-093	12,77	10	50	20001333-090	26,12	10	52	21000201-098	88,74	1	53
20000801-190 N	8,10	10	52	20001151-094	16,24	10	50	20001333-091	39,47	5	52	21000201-190 N	88,74	1	53

RELACIÓN NUMÉRICA DE ARTÍCULOS

ÍNDICE GENERAL - RELACIÓN NUMÉRICA POR ARTÍCULO

ARTÍCULO	PRECIO €	PIEZAS CAJA	PÁGINA	ARTÍCULO	PRECIO €	PIEZAS CAJA	PÁGINA	ARTÍCULO	PRECIO €	PIEZAS CAJA	PÁGINA	ARTÍCULO	PRECIO €	PIEZAS CAJA	PÁGINA
21000233-090	86,74	1	54	21000359-096	159,19	1	54	21001201-095	103,61	1	53	21001333-097	113,05	1	54
21000233-093	91,35	1	54	21000359-098	148,92	1	54	21001201-096	103,61	1	53	21001333-098	96,79	1	54
21000233-096	102,13	1	54	21000359-190	148,92	1	54	21001201-097	103,61	1	53	21001333-190	96,79	1	54
21000233-098	87,50	1	54	21000432-090	80,81	1	53	21001201-098	88,74	1	53	21001359-090	148,10	1	54
21000233-190	87,50	1	54	21000432-091	95,24	1	53	21001201-190	88,74	1	53	21001359-093	154,05	1	54
21000314-090	111,60	1	53	21000432-093	85,17	1	53	21001233-090	86,74	1	54	21001359-096	159,19	1	54
21000314-091	131,53	1	53	21000432-094	95,24	1	53	21001233-093	91,35	1	54	21001359-098	148,92	1	54
21000314-093	117,61	1	53	21000432-095	95,24	1	53	21001233-096	102,13	1	54	21001359-190	148,92	1	54
21000314-094	131,53	1	53	21000432-096	95,24	1	53	21001233-098	87,50	1	54	21010036-090	80,81	1	53
21000314-095	131,53	1	53	21000432-097	95,24	1	53	21001233-190	87,50	1	54	21010036-091	95,24	1	53
21000314-096	131,53	1	53	21000432-098	81,56	1	53	21001314-090	111,60	1	53	21010036-093	85,17	1	53
21000314-097	131,53	1	53	21000432-190	81,56	1	53	21001314-091	135,48	1	53	21010036-094	95,24	1	53
21000314-098	112,63	1	53	21000811-090	185,16	1	54	21001314-093	117,61	1	53	21010036-095	95,24	1	53
21000314-190	112,63	1	53	21000811-091	204,51	1	54	21001314-094	131,53	1	53	21010036-096	95,24	1	53
21000316-090	153,02	1	54	21000811-093	199,17	1	54	21001314-095	131,53	1	53	21010036-097	95,24	1	53
21000316-091	180,37	1	54	21000811-094	204,51	1	54	21001314-096	131,53	1	53	21010036-098	81,56	1	53
21000316-093	161,27	1	54	21000811-095	204,51	1	54	21001314-097	131,53	1	53	21010036-190	81,56	1	53
21000316-094	180,37	1	54	21000811-096	204,51	1	54	21001314-098	112,63	1	53	21011036-090	80,81	1	53
21000316-095	180,37	1	54	21000811-097	204,51	1	54	21001314-190	112,63	1	53	21011036-091	95,24	1	53
21000316-096	180,37	1	54	21000811-098	194,69	1	54	21001316-090	153,02	1	53	21011036-093	85,17	1	53
21000316-097	180,37	1	54	21000811-190	194,69	1	54	21001316-091	180,37	1	53	21011036-094	95,24	1	53
21000316-098	154,47	1	54	21000812-090	192,13	1	55	21001316-093	161,27	1	53	21011036-095	95,24	1	53
21000316-190	154,47	1	54	21000812-091	206,04	1	55	21001316-094	180,37	1	53	21011036-096	95,24	1	53
21000317-090	136,45	1	54	21000812-093	200,66	1	55	21001316-095	180,37	1	53	21011036-097	95,24	1	53
21000317-091	160,84	1	54	21000812-094	206,04	1	55	21001316-096	180,37	1	53	21011036-098	81,56	1	53
21000317-093	143,80	1	54	21000812-095	206,04	1	55	21001316-097	180,37	1	53	21011036-190	81,56	1	53
21000317-094	160,84	1	54	21000812-096	206,04	1	55	21001316-098	154,47	1	53	21021035-090	90,28	1	54
21000317-095	160,84	1	54	21000812-097	206,04	1	55	21001316-190	154,47	1	53	21021035-091	106,41	1	54
21000317-096	160,84	1	54	21000812-098	196,14	1	55	21001317-090	136,45	1	53	21021035-093	95,15	1	54
21000317-097	160,84	1	54	21000812-190	196,14	1	55	21001317-091	160,84	1	53	21021035-094	106,41	1	54
21000317-098	137,74	1	54	21001121-090	91,46	1	53	21001317-093	143,80	1	53	21021035-095	106,41	1	54
21000317-190	137,74	1	54	21001121-091	107,81	1	53	21001317-094	160,84	1	53	21021035-096	106,41	1	54
21000321-090	93,83	1	54	21001121-093	96,40	1	53	21001317-095	160,84	1	53	21021035-097	106,41	1	54
21000321-091	110,60	1	54	21001121-094	107,81	1	53	21001317-096	160,84	1	53	21021035-098	91,15	1	54
21000321-093	98,90	1	54	21001121-095	107,81	1	53	21001317-097	160,84	1	53	21021035-190	91,15	1	54
21000321-094	110,60	1	54	21001121-096	107,81	1	53	21001317-098	137,74	1	53	21032108-039	332,16	1	55, 62
21000321-095	110,60	1	54	21001121-097	107,81	1	53	21001317-190	137,74	1	53	21040035-090	98,58	1	54
21000321-096	110,60	1	54	21001121-098	92,32	1	53	21001321-090	93,83	1	53	21040035-091	116,17	1	54
21000321-097	110,60	1	54	21001121-190	92,32	1	53	21001321-091	110,60	1	53	21040035-093	103,88	1	54
21000321-098	94,71	1	54	21001133-090	87,92	1	54	21001321-093	98,90	1	53	21040035-094	116,17	1	54
21000321-190	94,71	1	54	21001133-091	103,61	1	54	21001321-094	110,60	1	53	21040035-095	116,17	1	54
21000333-090	95,91	1	54	21001133-093	92,65	1	54	21001321-095	110,60	1	53	21040035-096	116,17	1	54
21000333-091	113,05	1	54	21001133-094	103,61	1	54	21001321-096	110,60	1	53	21040035-097	116,17	1	54
21000333-093	101,08	1	54	21001133-095	103,61	1	54	21001321-097	110,60	1	53	21040035-098	99,50	1	54
21000333-094	113,05	1	54	21001133-096	103,61	1	54	21001321-098	94,71	1	53	21040035-190	99,50	1	54
21000333-095	113,05	1	54	21001133-097	103,61	1	54	21001321-190	94,71	1	53	21060035-090	137,52	1	54
21000333-096	113,05	1	54	21001133-098	88,72	1	54	21001333-090	95,91	1	54	21060035-091	170,01	1	54
21000333-097	113,05	1	54	21001133-190	88,72	1	54	21001333-091	113,05	1	54	21060035-093	147,20	1	54
21000333-098	96,79	1	54	21001201-090	87,92	1	53	21001333-093	101,08	1	54	21060035-094	170,01	1	54
21000333-190	96,79	1	54	21001201-091	103,61	1	53	21001333-094	113,05	1	54	21060035-095	170,01	1	54
21000359-090	148,10	1	54	21001201-093	92,65	1	53	21001333-095	113,05	1	54	21060035-096	154,55	1	54
21000359-093	154,05	1	54	21001201-094	103,61	1	53	21001333-096	113,05	1	54	21060035-097	170,01	1	54

ARTÍCULO	PRECIO €	PIEZAS CAJA	PÁGINA	ARTÍCULO	PRECIO €	PIEZAS CAJA	PÁGINA	ARTÍCULO	PRECIO €	PIEZAS CAJA	PÁGINA	ARTÍCULO	PRECIO €	PIEZAS CAJA	PÁGINA
21060035-098	140,19	1	54	27000630-095	21,38	1	47	2700620-030	6,12	10	65	2700679-038	4,15	5	64
21060035-190	140,19	1	54	27000630-096	21,38	1	47	2700620-031	6,30	10	65	2700679-109	4,15	5	64
26001-39	7,30	10	66	27000630-097	21,38	1	47	2700627-041	10,09	5	65	2700679-110	4,15	5	64
26101-39	4,49	10	66	27000630-098	10,18	5	47	2700627-042	21,34	5	65	2700679-111	4,15	5	64
26102-39	12,51	10	66	27000630-190	10,18	5	47	2700627-060	5,90	5	65	2700679-112	4,15	5	65
26104-39	12,51	10	66	27000640-090	10,48	1	47	2700627-071	3,42	5	65	2700751-030	6,58	10	65
26134-39	22,90	10	66	27000640-091	30,33	1	47	2700627-080	10,09	5	65	2700751-031	6,83	10	66
26150-39	4,67	10	66	27000640-093	15,88	1	47	2700627-081	10,09	5	65	2700752-030	11,82	5	66
26160-39	12,72	10	66	27000640-094	30,33	1	47	2700627-082	10,09	5	65	2700752-031	12,27	5	66
26201-39	5,47	10	66	27000640-095	30,33	1	47	2700627-084	10,09	5	65	2700753-030	15,36	5	66
26202-39	13,49	10	66	27000640-096	30,33	1	47	2700627-085	10,09	5	65	2700753-031	15,94	5	66
26204-39	13,55	10	66	27000640-097	30,33	1	47	2700627-086	10,09	5	65	2700802-037	9,83	10	64
26251-39	13,23	10	66	27000640-098	14,44	1	47	2700627-108	6,82	5	65	2700802-064	9,83	10	64
26254-39	21,36	10	66	27000640-190	14,44	1	47	2700627-112	3,42	5	65	2700950-030	8,85	5	64
26301-39	13,37	10	66	27000650-090	10,84	1	47	2700627-805	24,25	1	65	2700951-030	8,38	5	64
26333-39	25,33	10	66	27000650-091	41,02	1	47	2700630-030	10,07	10	65	2701090-030	25,75	1	64
26397-39	15,24	10	66	27000650-093	21,48	1	47	2700630-031	10,75	10	65	2701090-031	26,73	1	64
26398-39	10,78	10	66	27000650-094	41,02	1	47	2700637-041	13,12	5	65	2701090-038	26,97	1	64
26432-39	3,95	10	66	27000650-095	41,02	1	47	2700637-042	32,26	5	65	2701092-030	25,75	1	64
26458-39	3,79	10	66	27000650-096	41,02	1	47	2700637-060	8,88	5	65	2701092-031	26,73	1	64
26526-39	20,98	10	66	27000650-097	41,02	1	47	2700637-071	5,13	5	65	2701092-038	26,97	1	64
26550-39	22,21	10	66	27000650-098	19,52	1	47	2700637-080	13,12	5	65	2701093-030	25,75	1	64
26802-39	8,72	10	66	27000650-190	19,52	1	47	2700637-081	13,12	5	65	2701093-031	26,73	1	64
26803-39	8,72	10	66	2700091-030	30,95	1	64	2700637-082	13,12	5	65	2701093-038	26,97	1	64
26809-39	7,92	10	66	2700091-031	33,01	1	64	2700637-084	13,12	5	65	2701094-030	32,22	1	64
27000-31	7,34	20	62	2700091-038	32,15	1	64	2700637-085	13,12	5	65	2701094-031	33,45	1	64
27000-34	7,14	20	62	2700545-030	8,35	5	64	2700637-086	13,12	5	65	2701094-038	34,09	1	64
2700033-038	3,34	10	64	2700545-031	8,91	5	64	2700637-108	10,20	5	65	2701096-030	48,84	1	64
2700041-038	2,70	10	64	2700545-038	8,90	5	64	2700637-112	5,13	5	65	2701096-031	47,91	1	64
2700041-060	2,77	5	64	2700610-030	2,93	20	65	2700637-805	32,63	1	65	2701096-038	52,22	1	64
27000610-090	2,13	20	47	2700610-031	3,02	20	65	2700640-030	13,95	10	65	2701097-030	47,74	1	64
27000610-091	7,16	5	47	2700611-030	4,92	5	65	2700640-031	14,88	10	65	2701097-031	49,09	1	64
27000610-093	4,22	5	47	2700611-031	5,25	5	65	2700647-041	17,52	1	65	2701097-038	46,88	1	64
27000610-094	7,16	5	47	2700612-030	5,03	10	65	2700647-042	47,70	1	65	2701610-030	2,83	20	65
27000610-095	7,16	5	47	2700612-031	5,37	10	65	2700647-060	11,78	1	65	2701620-030	5,64	10	65
27000610-096	7,16	5	47	2700613-030	5,55	10	65	2700647-071	6,84	1	65	2701630-030	9,13	10	65
27000610-097	7,16	5	47	2700613-031	5,92	10	65	2700647-080	17,52	1	65	2701640-030	12,68	10	65
27000610-098	3,59	10	47	2700614-030	5,85	5	65	2700647-081	17,52	1	65	2702610-030	296,01	1	65
27000610-190	3,59	10	47	2700614-031	6,24	5	65	2700647-082	17,52	1	65	2702611-030	4,92	5	65
27000620-090	4,60	10	47	2700617-041	6,16	10	65	2700647-084	17,52	1	65	2702611-031	5,11	5	65
27000620-091	13,90	5	47	2700617-042	11,53	10	65	2700647-085	17,52	1	65	2702620-030	308,45	1	65
27000620-093	7,28	5	47	2700617-060	2,90	10	65	2700647-086	17,52	1	65	27028-32	4,67	20	62
27000620-094	13,90	5	47	2700617-071	1,62	10	65	2700647-108	13,59	1	65	27028-35	4,50	20	62
27000620-095	13,90	5	47	2700617-080	6,16	10	65	2700647-112	6,84	1	65	27036-35	5,98	5	62
27000620-096	13,90	5	47	2700617-081	6,16	10	65	2700647-805	39,30	1	65	2705010-030	5,29	10	79
27000620-097	13,90	5	47	2700617-082	6,16	10	65	2700670-033	3,24	20	64	2705010-033	17,04	5	79
27000620-098	6,79	10	47	2700617-084	6,16	10	65	2700670-038	0,82	20	64	2705010-063	5,29	10	79
27000620-190	6,79	10	47	2700617-085	6,16	10	65	2700670-066	3,85	20	64	2705011-030	5,95	5	79
27000630-090	7,65	5	47	2700617-086	6,16	10	65	2700670-109	0,82	20	64	2705011-033	17,95	5	79
27000630-091	21,38	1	47	2700617-108	3,21	10	65	2700670-110	0,82	20	64	2705011-063	5,86	5	79
27000630-093	11,21	1	47	2700617-112	1,65	10	65	2700670-111	0,82	20	64	2705026-030	8,16	5	79
27000630-094	21,38	1	47	2700617-805	12,98	5	65	2700670-112	0,82	20	64	2705026-063	8,28	5	79

RELACIÓN NUMÉRICA DE ARTÍCULOS

ÍNDICE GENERAL - RELACIÓN NUMÉRICA POR ARTÍCULO

ARTÍCULO	PRECIO €	PIEZAS CAJA	PÁGINA	ARTÍCULO	PRECIO €	PIEZAS CAJA	PÁGINA	ARTÍCULO	PRECIO €	PIEZAS CAJA	PÁGINA	ARTÍCULO	PRECIO €	PIEZAS CAJA	PÁGINA
2705036-096	4,85	5	79	27089-34	3,12	20	63	27110-31	1,06	10	63	27111620-097	17,83	5	48
2705036-102	4,85	5	79	27089-35	3,01	20	63	27110610-090	5,02	10	48	27111620-098	8,34	5	48
2705036-108	4,85	5	79	27094-31	1,06	10	63	27110610-091	12,29	5	48	27111620-190 ^N	8,34	5	48
2705041-030	3,43	10	79	27096-31	1,06	10	63	27110610-093	8,20	5	48	27111630-090	8,02	5	48
2705041-063	3,48	10	79	27097-31	3,37	20	63	27110610-094	12,29	5	48	27111630-091	27,44	1	48
2705062-030	3,39	5	79	27097-34	3,16	20	63	27110610-095	12,29	5	48	27111630-093	18,12	1	48
2705062-063	3,51	5	79	27097-37	3,34	5	63	27110610-096	12,29	5	48	27111630-094	27,44	1	48
2705088-030	7,56	5	79	27097-38	3,41	10	63	27110610-097	12,29	5	48	27111630-095	27,44	1	48
2705088-063	7,85	5	80	2710010-038	1,95	10	64	27110610-098	6,78	10	48	27111630-096	27,44	1	48
2705091-030	16,51	5	80	2710010-109	2,92	5	64	27110610-190 ^N	6,78	10	48	27111630-097	27,44	1	48
2705091-033	29,33	5	80	2710010-110	2,92	5	64	27110620-090	8,69	10	48	27111630-098	12,84	1	48
2705091-063	17,14	5	80	2710010-111	2,92	5	64	27110620-091	15,65	5	48	27111630-190 ^N	12,84	1	48
2705092-030	9,57	5	80	2710010-112	2,92	5	64	27110620-093	12,50	5	48	27116-31	1,06	10	63
2705092-033	24,32	5	80	27101-61	4,74	20	63	27110620-094	15,65	5	48	27133-62	15,29	10	63
2705092-063	9,93	5	80	27101-62	4,67	10	63	27110620-095	15,65	5	48	27133-65	15,29	10	63
2705097-030	4,62	5	80	27101-64	4,61	20	63	27110620-096	15,65	5	48	27134-61	26,07	5	63
2705097-063	4,78	5	80	27101-65	4,67	10	63	27110620-097	15,65	5	48	27134-62	26,14	10	63
27053-31	3,37	20	62	27101610-090	3,42	10	47	27110620-098	10,94	10	48	27134-64	25,33	5	63
27053-34	3,16	20	62	27101610-091	9,16	5	47	27110620-190 ^N	10,94	10	48	27134-65	26,14	10	63
27054-62	5,74	10	62	27101610-093	6,49	5	47	27110630-090	12,08	5	48	27134-67	26,90	5	63
27054-65	5,53	10	62	27101610-094	9,16	5	47	27110630-091	23,73	1	48	27150-61	7,22	20	63
2705610-030	9,56	10	80	27101610-095	9,16	5	47	27110630-093	18,57	1	48	27150-62	7,05	10	63
2705610-033	29,71	5	80	27101610-096	9,16	5	47	27110630-094	23,73	1	48	27150-64	6,76	20	63
2705610-063	9,56	10	80	27101610-097	9,16	5	47	27110630-095	23,73	1	48	27150-65	6,78	10	63
2705610-124	11,47	10	80	27101610-098	5,37	10	47	27110630-096	23,73	1	48	27151-61	7,35	20	63
2705620-030	18,26	5	80	27101610-190 ^N	5,37	10	47	27110630-097	23,73	1	48	27151-62	7,18	10	63
2705620-033	54,85	1	80	27101620-090	5,64	10	47	27110630-098	15,56	1	48	27151-64	6,89	20	63
2705620-063	18,26	5	80	27101620-091	17,83	5	47	27110630-190 ^N	15,56	1	48	27151-65	6,91	10	63
2705620-124	21,86	5	80	27101620-093	11,59	5	47	27110640-090	15,46	1	48	27153-62	16,95	10	63
2705630-030	31,67	5	80	27101620-094	17,83	5	47	27110640-091	29,44	1	48	27153-65	16,63	10	63
2705630-063	32,12	5	80	27101620-095	17,83	5	47	27110640-093	23,51	1	48	27160-61	15,77	20	63
2705630-124	40,04	5	80	27101620-096	17,83	5	47	27110640-094	29,44	1	48	27160-62	15,45	10	63
2705891-039	11,72	5	80	27101620-097	17,83	5	47	27110640-095	29,44	1	48	27160-64	14,76	20	63
2705950-030	4,93	5	80	27101620-098	9,15	10	47	27110640-096	29,44	1	48	27160-65	14,87	10	63
27060-32	4,67	5	62	27101620-190 ^N	9,15	10	47	27110640-097	29,44	1	48	27161-61	16,05	20	63
27060-35	4,50	5	62	27101630-090	8,62	5	48	27110640-098	20,18	1	48	27161-62	15,81	10	63
27075-32	7,66	10	62	27101630-091	27,44	1	48	27110640-190 ^N	20,18	1	48	27161-64	15,05	20	63
27075-35	7,66	10	62	27101630-093	17,54	1	48	27110650-090	20,54	1	48	27161-65	15,23	10	63
27078-30	9,32	5	62	27101630-094	27,44	1	48	27110650-091	38,31	1	48	27190610-090	56,28	1	51
27078-31	9,94	5	62	27101630-095	27,44	1	48	27110650-093	31,79	1	48	27190610-091	68,31	1	51
27078-38	11,26	5	62	27101630-096	27,44	1	48	27110650-094	38,31	1	48	27190610-093	61,07	1	51
27081-32	8,59	10	62	27101630-097	27,44	1	48	27110650-095	38,31	1	48	27190610-094	68,31	1	51
27081-35	8,28	10	62	27101630-098	13,87	1	48	27110650-096	38,31	1	48	27190610-095	68,31	1	51
27081-37	8,59	5	62	27101630-190 ^N	13,87	1	48	27110650-097	38,31	1	48	27190610-096	68,31	1	51
27086-32	9,38	10	62	27102-61	14,16	20	63	27110650-098	26,45	1	48	27190610-097	68,31	1	51
27086-35	9,03	10	62	27102-62	14,16	10	63	27110650-190 ^N	26,45	1	48	27190610-098	58,51	1	51
27086-37	9,38	5	62	27102-64	13,76	20	63	27111620-090	5,21	5	48	27190620-090	4,94	5	47
27087-31	5,55	10	62	27102-65	14,16	10	63	27111620-091	17,83	5	48	27190620-091	18,25	1	47
27087-32	7,89	10	63	27104-61	13,65	20	63	27111620-093	13,38	5	48	27190620-093	7,89	1	47
27087-34	5,20	10	62	27104-62	13,76	10	63	27111620-094	17,83	5	48	27190620-094	18,25	1	47
27087-35	7,60	10	63	27104-64	13,26	20	63	27111620-095	17,83	5	48	27190620-095	18,25	1	47
27087-37	7,89	10	63	27104-65	13,76	10	63	27111620-096	17,83	5	48	27190620-096	18,25	1	47

ARTÍCULO	PRECIO €	PIEZAS CAJA	PÁGINA	ARTÍCULO	PRECIO €	PIEZAS CAJA	PÁGINA	ARTÍCULO	PRECIO €	PIEZAS CAJA	PÁGINA	ARTÍCULO	PRECIO €	PIEZAS CAJA	PÁGINA
27190620-097	18,25	1	47	27192610-096	10,41	1	47	27204-67	15,61	10	63	27480-34	13,37	20	63
27190620-098	7,89	5	47	27192610-097	10,41	1	47	27211-61	9,68	5	63	27480-35	13,91	10	63
27190620-190	7,89	5	47	27192610-098	6,10	1	47	27211-62	9,71	10	63	27481-31	15,88	20	63
27190630-090	7,60	5	47	27192610-190	6,10	1	47	27211-64	9,41	5	63	27481-32	16,74	10	63
27190630-091	28,06	1	47	27192620-090	4,94	5	48	27211-65	9,71	10	63	27481-34	15,03	20	63
27190630-093	12,16	1	47	27192620-091	18,25	1	48	27212-62	19,03	10	63	27481-35	16,28	10	63
27190630-094	28,06	1	47	27192620-093	7,89	1	48	27212-65	18,33	10	63	27481-37	16,28	5	63
27190630-095	28,06	1	47	27192620-094	18,25	1	48	2721313-039	58,52	5	64	27481-38	16,78	10	63
27190630-096	28,06	1	47	27192620-095	18,25	1	48	2721316-039	61,86	5	64	27486-32	8,01	10	63
27190630-097	28,06	1	47	27192620-096	18,25	1	48	27251-61	14,77	20	63	27486-35	7,78	10	63
27190630-098	12,16	1	47	27192620-097	18,25	1	48	27251-62	14,34	10	63	27486-37	8,01	10	63
27190630-190	12,16	1	47	27192620-098	7,89	5	48	27251-64	14,35	20	63	27488-32	7,53	10	63
27190640-090	10,25	1	47	27192620-190	7,89	5	48	27251-65	14,34	10	63	27488-35	7,32	10	63
27190640-091	37,90	1	47	27192630-090	7,60	5	48	27254-61	25,29	20	63	27489-32	9,26	10	63
27190640-093	16,42	1	47	27192630-091	28,06	1	48	27254-62	24,82	10	63	27489-35	9,00	10	63
27190640-094	37,90	1	47	27192630-093	12,16	1	48	27254-64	23,71	20	63	27490-32	10,55	10	63
27190640-095	37,90	1	47	27192630-094	28,06	1	48	27254-65	23,91	10	63	27490-35	10,25	10	63
27190640-096	37,90	1	47	27192630-095	28,06	1	48	27313-31	121,27	1	63	27490-37	10,25	10	63
27190640-097	37,90	1	47	27192630-096	28,06	1	48	27313-34	118,02	1	63	27505-32	10,21	5	63
27190640-098	16,42	1	47	27192630-097	28,06	1	48	27332-32	36,04	5	63	27505-35	10,21	5	63
27190640-190	16,42	1	47	27192630-098	12,16	1	48	27332-35	34,72	5	63	27520-62	104,27	1	63
27191610-090	59,41	1	51	27192630-190	12,16	1	48	27333-61	33,75	5	63	27520-65	104,27	1	63
27191610-091	70,33	1	51	27193630-090	7,60	5	47	27333-62	33,73	10	63	27520-68	106,34	1	63
27191610-093	61,85	1	51	27193630-091	28,06	1	47	27333-64	31,64	5	63	27521-62	104,27	1	63
27191610-094	70,33	1	51	27193630-093	12,16	1	47	27333-65	32,80	10	63	27521-65	104,27	1	63
27191610-095	70,33	1	51	27193630-094	28,06	1	47	27342-31	176,86	1	63	27521-68	106,34	1	63
27191610-096	70,33	1	51	27193630-095	28,06	1	47	27342-34	167,39	1	63	27522-62	114,16	1	63
27191610-097	70,33	1	51	27193630-096	28,06	1	47	27396-62	20,26	10	63	27522-65	114,16	1	63
27191610-098	61,85	1	51	27193630-097	28,06	1	47	27396-65	19,51	10	63	27522-68	116,44	1	63
27191620-090	4,94	5	48	27193630-098	12,16	1	47	27431-61	5,18	20	63	27523-62	114,16	1	64
27191620-091	18,25	1	48	27193630-190	12,16	1	47	27431-62	6,68	10	63	27523-65	114,16	1	64
27191620-093	7,89	1	48	2720010-038	2,18	10	64	27431-64	5,03	20	63	27523-68	116,44	1	64
27191620-094	18,25	1	48	2720010-060	3,03	5	64	27431-65	6,68	10	63	27562-30	5,64	10	64
27191620-095	18,25	1	48	2720010-108	3,03	5	64	27432-62	5,88	10	63	27562-31	5,96	10	64
27191620-096	18,25	1	48	2720010-109	3,09	5	64	27432-65	5,88	10	63	27659-61	6,63	20	64
27191620-097	18,25	1	48	2720010-110	3,09	5	64	27432-68	6,75	10	63	27659-62	6,79	10	64
27191620-098	7,89	5	48	2720010-111	3,09	5	64	27438-31	9,56	20	63	27659-64	6,44	20	64
27191620-190	7,89	5	48	2720010-112	3,09	5	64	27438-34	9,29	20	63	27659-65	6,60	10	64
27191630-090	7,60	5	48	27201-61	5,55	20	63	27439-32	10,25	10	63	27659-67	6,79	10	64
27191630-091	28,06	1	48	27201-62	5,41	10	63	27439-35	10,25	10	63	27669-61	16,54	20	64
27191630-093	12,16	1	48	27201-64	5,39	20	63	27439-38	10,57	10	63	27669-62	15,77	10	64
27191630-094	28,06	1	48	27201-65	5,41	10	63	27442-61	5,94	20	63	27669-64	15,65	20	64
27191630-095	28,06	1	48	27201-66	5,78	20	63	27442-64	5,77	20	63	27669-65	15,77	10	64
27191630-096	28,06	1	48	27201-67	6,03	10	63	27458-32	12,38	10	63	27669-67	15,77	10	64
27191630-097	28,06	1	48	27202-61	15,64	20	63	27458-35	12,38	10	63	27710-31	2,03	25	65
27191630-098	12,16	1	48	27202-62	15,82	10	63	27472-62	5,88	10	63	27711-31	2,95	25	66
27191630-190	12,16	1	48	27202-64	14,66	20	63	27472-65	5,88	10	63	27714-31	5,47	10	65
27192610-090	4,87	1	47	27202-65	15,24	10	63	27472-67	6,05	10	63	27800-31	3,83	20	64
27192610-091	10,41	1	47	27204-61	15,39	20	63	27475-31	9,79	20	63	27800-32	3,81	10	64
27192610-093	6,10	1	47	27204-62	15,61	10	63	27475-34	9,53	20	63	27800-34	3,59	20	64
27192610-094	10,41	1	47	27204-64	14,43	20	63	27480-31	13,23	20	63	27800-35	3,70	10	64
27192610-095	10,41	1	47	27204-65	15,04	10	63	27480-32	14,44	10	63	27800-37	3,81	10	64

RELACIÓN NUMÉRICA DE ARTÍCULOS

ÍNDICE GENERAL - RELACIÓN NUMÉRICA POR ARTÍCULO

ARTÍCULO	PRECIO €	PIEZAS CAJA	PÁGINA	ARTÍCULO	PRECIO €	PIEZAS CAJA	PÁGINA	ARTÍCULO	PRECIO €	PIEZAS CAJA	PÁGINA	ARTÍCULO	PRECIO €	PIEZAS CAJA	PÁGINA
27800-38	4,02	10	64	28065-30	3,10	10	66	31397-31	33,09	10	67	31690-31	7,35	10	67
27801-31	6,64	20	64	28065-31	2,74	10	66	31398-30	26,86	10	67	31702-61	17,80	5	67
27801-32	6,61	10	64	28065-32	2,74	10	66	31398-31	27,61	10	67	31710-61	0,66	250	67, 107
27801-34	6,40	20	64	28067-30	6,31	10	66	31430-61	12,97	10	67	31711-31	2,82	10	67
27801-35	6,42	10	64	28068-30	8,67	10	66	31431-60	13,01	10	67	31712-61	2,55	240	67
27801-37	6,61	5	64	28082-30	9,79	10	66	31431-61	13,37	10	67	31722-61	4,70	100	67
27802-39	10,51	10	66	28085-30	10,48	10	66	31432-60	12,74	10	67	31732-61	7,03	50	67
27804-64	28,28	5	64	28088-30	3,39	10	66	31432-61	13,09	10	67	31742-61	9,23	25	67
27805-64	38,21	5	64	28089-30	10,48	10	66	31432-67	14,11	10	67	31750-30	11,15	10	67
27805-65	38,21	5	64	2811096-030	3,10	5	66	31464-60	12,74	10	67	31750-31	11,46	10	67
27806-32	26,80	10	64	28545-30	10,66	5	66	31464-61	13,09	10	67	31751-30	12,82	10	67
27806-35	26,04	10	64	28610-30	2,91	10	66	31472-60	13,25	10	67	31751-31	13,18	10	67
27808-31	12,26	20	64	28620-30	4,77	10	66	31472-61	13,61	10	67	31753-30	7,38	10	67
27808-34	11,58	20	64	28630-30	6,44	10	66	31480-30	18,83	10	67	31753-31	7,59	10	67
27810-31	12,26	20	64	28640-30	8,46	10	66	31480-31	19,35	10	67	31800-30	10,66	10	67
27810-34	12,26	20	64	28800-30	3,82	10	66	31481-30	21,79	10	67	31800-31	10,96	10	67
27811-32	7,16	10	65	2890432-030	5,17	10	66	31481-31	22,39	10	67	31801-30	16,16	10	67
27811-35	6,89	10	65	31053-60	2,75	10	66	31545-30	16,58	5	67	31801-31	16,61	10	67
27821-32	12,71	5	65	31053-61	2,82	10	66	31545-31	17,04	5	67	31806-30	36,91	10	67
27821-35	12,25	5	65	31054-30	9,34	10	66	31562-30	6,02	10	67	31806-31	37,93	10	67
27831-32	16,42	5	65	31054-31	9,60	10	66	31562-31	6,19	10	67	31970-61	0,52	100	67
27831-35	15,82	5	65	31085-60	15,74	5	66	31610-30	5,61	20	67	40000089-030	3,73	10	93
27889-39	1,41	10	64	31085-61	16,18	5	66	31610-31	5,76	20	67	40000089-038	3,73	10	93
27890-32	3,17	10	66	31088-30	6,11	10	66	31611-30	3,95	20	67	40000189-030	2,31	10	93
27890-35	3,05	10	66	31088-31	6,28	10	66	31611-31	4,06	20	67	40000189-038	2,31	10	93
27891-31	1,88	10	64	31089-60	16,42	5	66	31620-30	9,43	10	67	40000191-030	54,97	1	93
27898-31	3,67	10	64	31089-61	16,88	5	66	31620-31	9,68	10	67	40000191-038	54,97	1	93
2791432-030	7,40	10	64	31097-60	2,87	10	66	31621-30	6,64	10	67	40000800-030	2,78	10	93
2791432-031	7,62	10	64	31097-61	2,95	10	66	31621-31	6,82	10	67	40000800-038	2,78	10	93
27996-39	3,40	20	66, 78	31101-30	13,76	10	67	31630-30	16,30	10	67	40001191-030	50,39	1	93
27997-39	4,73	5	64	31101-31	14,15	10	67	31630-31	16,64	10	67	40001191-038	50,39	1	93
27999-39	9,99	10	64	31133-30	26,28	10	67	31631-30	12,62	10	67	40001193-030	68,73	1	93
28010-30	2,55	20	66	31133-31	27,01	10	67	31631-31	12,97	10	67	40001193-038	68,73	1	93
28011-30	2,96	20	66	31134-30	34,49	10	67	31640-30	23,45	10	67	40001194-030	53,84	1	93
28012-30	2,96	20	66	31134-31	35,45	10	67	31640-31	24,08	10	67	40001194-038	53,84	1	93
28015-30	3,02	20	66	31201-30	15,03	10	67	31641-30	17,27	10	67	40011189-030	2,31	10	93
28016-30	3,02	20	66	31201-31	15,45	10	67	31641-31	17,75	10	67	40011189-038	2,31	10	93
28017-30	2,66	20	66	31202-30	31,59	10	67	31650-30	15,60	10	67	40013089-030	3,73	10	93
28018-30	2,67	20	66	31202-31	32,47	10	67	31650-31	16,03	10	67	40013089-038	3,73	10	93
28026-30	3,62	20	66	31204-30	27,93	10	67	31651-30	15,60	10	67	40015089-030	3,73	10	93
28027-30	2,82	20	66	31204-31	28,71	10	67	31651-31	16,03	10	67	40015089-038	3,73	10	93
28028-30	3,96	20	66	31211-30	17,71	10	67	31659-30	15,11	10	67	40015189-030	2,31	10	93
28033-30	6,04	5	66	31211-31	18,20	10	67	31659-31	15,53	10	67	40015189-038	2,31	10	93
28041-60	2,97	10	66	31301-30	30,74	10	67	31659-60	15,11	10	67	40016089-030	3,73	10	93
28051-30	2,97	10	66	31301-31	31,60	10	67	31659-61	15,53	10	67	40016089-038	3,73	10	93
28052-30	2,97	10	66	31331-30	39,05	10	67	31660-30	26,16	10	67	40019089-030	3,73	10	93
28053-30	2,53	10	66	31331-31	40,13	10	67	31660-31	26,89	10	67	40019089-038	3,73	10	93
28054-30	5,13	10	66	31333-60	37,16	10	67	31661-30	25,99	10	67	40019189-030	2,31	10	93
28055-30	5,14	10	66	31333-61	38,19	10	67	31661-31	26,71	10	67	40019189-038	2,31	10	93
28056-30	3,99	10	66	31396-30	26,17	10	67	31669-30	24,19	10	67	42322000-130	120,01	1	90
28057-30	2,69	10	66	31396-31	26,90	10	67	31669-31	24,86	10	67	42322000-138	120,01	1	90
28062-30	2,91	10	66	31397-30	32,20	10	67	31690-30	7,15	10	67	42332000-130*	122,45	1	90

ARTÍCULO	PRECIO €	PIEZAS CAJA	PÁGINA	ARTÍCULO	PRECIO €	PIEZAS CAJA	PÁGINA	ARTÍCULO	PRECIO €	PIEZAS CAJA	PÁGINA	ARTÍCULO	PRECIO €	PIEZAS CAJA	PÁGINA
42332000-138*	122,45	1	90	42606000-138	100,33	1	90	4400468-035	27,35	5	80	44533020-138*	260,60	1	91
42401000-130	72,03	1	90	42623000-130	137,11	1	90	4400472-030	12,33	10	80	44570-38	23,14	10	81
42401000-138	72,03	1	90	42623000-138	137,11	1	90	4400472-035	11,73	10	80	44601000-130	200,60	1	91
42402000-130	75,93	1	90	42624000-130	141,01	1	90	4400610-030	9,99	5	80	44601000-138	200,60	1	91
42402000-138	75,93	1	90	42624000-138	141,01	1	90	4400610-035	8,32	5	80	44602000-130	204,49	1	91
42403000-130	79,83	1	90	43100001-130	20,30	1	93	4400620-030	23,18	5	80	44602000-138	204,49	1	91
42403000-138	79,83	1	90	43100001-138	20,30	1	93	4400620-035	21,45	5	80	44602240-130	250,67	1	91
42403020-130	97,27	1	90	43100002-130	20,30	1	93	4400630-030	34,28	5	80	44602240-138	250,67	1	91
42403020-138	97,27	1	90	43100002-138	20,30	1	93	4400630-035	28,56	5	80	44603000-130	208,39	1	91
42404000-130	83,73	1	90	43101000-130	31,50	1	93	4400751-030	5,12	10	80	44603000-138	208,39	1	91
42404000-138	83,73	1	90	43101000-138	31,50	1	93	4400751-035	4,89	10	80	44604000-130	212,29	1	91
42422000-130	124,41	1	90	43101002-130	35,25	1	93	4400761-030	17,83	5	80	44604000-138	212,29	1	91
42422000-138	124,41	1	90	43101002-138	35,25	1	93	4400761-035	15,97	5	80	44604040-130	237,04	1	91
42423000-130	128,31	1	90	43120000-130	61,06	1	93	4400763-030	17,83	5	80	44604040-138	237,04	1	91
42423000-138	128,31	1	90	43120000-138	61,06	1	93	4400763-035	15,97	5	80	44605000-130	216,19	1	91
42432000-130*	126,85	1	90	43120200-130	#N/D	1	93	4400765-030	27,90	5	80	44605000-138	216,19	1	91
42432000-138*	126,85	1	90	43120200-138	64,80	1	93	4400765-035	24,98	5	80	44606000-130	220,09	1	90
42501000-130	76,43	1	90	4400010-030	6,22	10	81	44401000-130	182,47	1	91	44606000-138	220,09	1	90
42501000-138	76,43	1	90	4400010-035	5,41	10	81	44401000-138	182,47	1	91	44623000-130	256,87	1	91
42502000-130	80,33	1	90	4400026-030	11,29	5	81	44402000-130	186,37	1	91	44623000-138	256,87	1	91
42502000-138	80,33	1	90	4400026-033	6,22	5	81	44402000-138	186,37	1	91	44624000-130	260,77	1	91
42502220-130	107,90	1	90	4400026-035	9,83	5	81	44403000-130	190,26	1	91	44624000-138	260,77	1	91
42502220-138	107,90	1	90	4400026-037	3,33	5	81	44403000-138	190,26	1	91	44633000-130*	259,31	1	91
42503000-130	84,23	1	90	4400026-065	3,33	5	81	44403020-130	211,35	1	90	44633000-138*	259,31	1	91
42503000-138	84,23	1	90	4400036-100	8,28	5	81	44403020-138	211,35	1	90	4490150-030	15,26	10	80
42504000-130	88,13	1	90	4400036-102	7,21	5	81	44404000-130	194,16	1	90	4490150-035	13,26	10	80
42504000-138	88,13	1	90	4400088-035	5,23	5	81	44404000-138	194,16	1	90	4490160-030	24,08	10	80
42504020-130	99,83	1	90	4400092-030	7,25	10	81	44422000-130	234,85	1	91	4490160-035	20,94	10	80
42504020-138	99,83	1	90	4400092-035	6,29	10	81	44422000-138	234,85	1	91	4490201-030	13,60	10	80
42505000-130	92,03	1	90	4400150-030	11,09	5	80	44423000-130	238,74	1	90	4490201-035	11,82	10	80
42505000-138	92,03	1	90	4400150-035	10,55	5	80	44423000-138	238,74	1	90	4490202-030	25,62	10	80
42523000-130	132,71	1	90	4400160-030	19,83	5	80	44432000-130*	237,28	1	91	4490202-035	22,27	10	80
42523000-138	132,71	1	90	4400160-035	18,89	5	80	44432000-138*	237,28	1	91	4490204-030	24,39	10	80
42523020-130	138,71	1	90	4400201-030	10,50	10	80	44501000-130	191,51	1	91	4490204-035	21,21	10	80
42523020-138	138,71	1	90	4400201-035	10,00	10	80	44501000-138	191,51	1	91	4490432-035	15,27	10	80
42533020-130*	141,14	1	90	4400202-030	20,60	5	80	44502000-130	195,40	1	91	4490433-035	34,30	5	80
42533020-138*	141,14	1	90	4400202-035	19,61	5	80	44502000-138	195,40	1	91	4490472-030	17,57	10	80
42601000-130	80,83	1	90	4400204-030	20,39	5	80	44502220-130	237,82	1	91	4490472-035	15,27	10	80
42601000-138	80,83	1	90	4400204-035	19,41	5	80	44502220-138	237,82	1	91	4490473-030	39,46	5	80
42602000-130	84,73	1	90	4400251-030	19,96	5	80	44503000-130	199,30	1	91	4490473-035	34,30	5	80
42602000-138	84,73	1	90	4400251-035	19,01	5	80	44503000-138	199,30	1	91	4490780-035	5,73	10	81
42602240-130	119,87	1	90	4400394-030	38,58	5	80	44504000-130	203,20	1	91	4499150-030	18,97	5	80
42602240-138	119,87	1	90	4400394-035	36,75	5	80	44504000-138	203,20	1	91	4499150-035	17,24	5	80
42603000-130	88,63	1	90	4400397-030	20,88	5	80	44504020-130	224,20	1	91	4499201-030	16,91	5	80
42603000-138	88,63	1	90	4400397-035	19,88	5	80	44504020-138	224,20	1	91	4499201-035	15,37	5	80
42604000-130	92,53	1	90	4400432-030	12,33	10	80	44505000-130	207,10	1	90	4499472-030	21,82	5	80
42604000-138	92,53	1	90	4400432-035	11,73	10	80	44505000-138	207,10	1	90	4499472-035	19,84	5	80
42604040-130	106,50	1	90	4400466-030	28,74	5	81	44519-38	17,79	10	81	4499473-030	49,04	5	80
42604040-138	106,50	1	90	4400466-035	27,35	5	80	44523020-130	255,68	1	91	4499473-035	44,58	5	80
42605000-130	96,43	1	90	4400467-030	28,74	5	81	44523020-138	255,68	1	91	45401000-130	221,25	1	91
42605000-138	96,43	1	90	4400467-035	27,35	5	80	44529-38	36,32	5	81	45401000-138	221,25	1	91
42606000-130	100,33	1	90	4400468-030	28,74	5	81	44533020-130*	260,60	1	91	45402000-130	225,15	1	92

RELACIÓN NUMÉRICA DE ARTÍCULOS

ÍNDICE GENERAL - RELACIÓN NUMÉRICA POR ARTÍCULO

ARTÍCULO	PRECIO €	PIEZAS CAJA	PÁGINA	ARTÍCULO	PRECIO €	PIEZAS CAJA	PÁGINA	ARTÍCULO	PRECIO €	PIEZAS CAJA	PÁGINA	ARTÍCULO	PRECIO €	PIEZAS CAJA	PÁGINA
45402000-138	225,15	1	92	46402000-138	372,73	1	92	47603000-138	504,76	1	93	50000181-033	6,13	20	98
45403000-130	229,05	1	92	46403000-130	380,53	1	92	47604000-130	512,55	1	93	50000181-038	5,20	20	98
45403000-138	229,05	1	92	46403000-138	380,53	1	92	47604000-138	512,55	1	93	50000185-030	3,50	10	98
45403020-130	249,77	1	91	46403020-130	422,70	1	92	47604040-130	561,20	1	92	50000185-033	5,19	10	98
45403020-138	249,77	1	91	46403020-138	422,70	1	92	47604040-138	561,20	1	92	50000185-038	3,56	10	98
45404000-130	232,95	1	91	46404000-130	388,32	1	92	47605000-130	520,35	1	93	50000186-030	6,46	20	98
45404000-138	232,95	1	91	46404000-138	388,32	1	92	47605000-138	520,35	1	93	50000186-033	7,76	20	98
45422000-130	273,63	1	91	46422000-130	469,69	1	92	47606000-130	528,15	1	92	50000186-038	6,58	20	98
45422000-138	273,63	1	91	46422000-138	469,69	1	92	47606000-138	528,15	1	92	50000189-030	4,17	20	99
45423000-130	277,53	1	91	46423000-130	477,49	1	92	47623000-130	601,72	1	93	50000189-033	6,19	20	99
45423000-138	277,53	1	91	46423000-138	477,49	1	92	47623000-138	601,72	1	93	50000189-038	4,26	20	99
45501000-130	232,97	1	91	46601000-130	401,19	1	92	47624000-130	609,51	1	93	50000432-030	16,03	10	96
45501000-138	232,97	1	91	46601000-138	401,19	1	92	47624000-138	609,51	1	93	50000432-037	16,03	10	96
45502000-130	236,87	1	92	46602000-130	408,99	1	92	48442-31	14,75	5	87	50000458-030	16,03	10	96
45502000-138	236,87	1	92	46602000-138	408,99	1	92	48453-31	17,01	10	87	50000458-037	16,03	10	96
45502220-130	278,82	1	91	46602240-130	501,35	1	92	48472-31	21,46	5	87	50000458-038	16,36	10	96
45502220-138	278,82	1	91	46602240-138	501,35	1	92	48473-31	18,86	10	87	50000459-037	19,31	10	96
45503000-130	240,76	1	92	46603000-130	416,79	1	92	48720-35	3,84	10	87	50000468-030	16,03	10	96
45503000-138	240,76	1	92	46603000-138	416,79	1	92	49114000-039	47,22	1	127	50000468-037	16,03	10	96
45504000-130	244,66	1	92	46604000-130	424,58	1	92	49115000-039	54,30	1	127	50000468-038	16,36	10	96
45504000-138	244,66	1	92	46604000-138	424,58	1	92	49116000-039	60,73	1	127	50000469-037	19,31	10	96
45504020-130	265,19	1	91	46604040-130	474,09	1	92	49117000-039	67,54	1	127	50000472-030	16,03	10	97
45504020-138	265,19	1	91	46604040-138	474,09	1	92	49118000-039	74,14	1	127	50000472-037	16,03	10	97
45505000-130	248,56	1	91	46605000-130	432,38	1	92	49119000-039	80,73	1	127	50000800-030	5,72	10	99
45505000-138	248,56	1	91	46605000-138	432,38	1	92	49120500-039	54,34	1	127	50000800-033	7,42	10	99
45523000-130	289,24	1	91	46606000-130	440,18	1	92	49120700-039	67,55	1	127	50000800-038	5,80	10	99
45523000-138	289,24	1	91	46606000-138	440,18	1	92	49133300-039	76,81	1	127	50000801-039	1,52	10	99,100
45523020-130	296,66	1	91	46623000-130	513,75	1	92	49134400-039	87,78	1	127	50000802-039	4,14	10	97
45523020-138	296,66	1	91	46623000-138	513,75	1	92	49143010-039	65,98	1	127	50000803-039	1,28	20	96
45601000-130	244,58	1	91	46624000-130	521,54	1	92	49146010-039	86,85	1	127	50000996-039	2,30	20	96
45601000-138	244,58	1	91	46624000-138	521,54	1	92	49204004-030	44,66	1	127	50001041-038	3,93	10	97
45602000-130	248,48	1	92	47401000-130	442,50	1	93	49204004-038	44,66	1	127	50001075-030	25,06	5	97
45602000-138	248,48	1	92	47401000-138	442,50	1	93	50000074-030	14,61	10	97	50001075-038	25,19	5	97
45602240-130	294,21	1	91	47402000-130	450,30	1	93	50000074-038	14,92	10	97	50001081-030	22,90	20	97
45602240-138	294,21	1	91	47402000-138	450,30	1	93	50000075-030	26,91	5	97	50001081-033	23,38	20	97
45603000-130	252,38	1	92	47403000-130	458,10	1	93	50000075-038	27,06	5	97	50001081-038	22,95	20	97
45603000-138	252,38	1	92	47403000-138	458,10	1	93	50000076-039	2,28	10	97	50001085-030	22,84	20	97
45604000-130	256,28	1	92	47403020-130	499,53	1	92	50000081-030	5,37	20	98	50001085-033	23,34	20	97
45604000-138	256,28	1	92	47403020-138	499,53	1	92	50000081-033	6,45	20	98	50001085-038	22,91	20	97
45604040-130	280,60	1	91	47404000-130	465,89	1	92	50000081-038	5,48	20	98	50001086-030	42,39	20	97
45604040-138	280,60	1	91	47404000-138	465,89	1	92	50000085-030	5,99	20	98	50001086-033	44,92	20	97
45605000-130	260,18	1	92	47422000-130	547,26	1	93	50000085-033	7,07	20	98	50001086-038	42,46	20	97
45605000-138	260,18	1	92	47422000-138	547,26	1	93	50000085-038	6,14	20	98	50001089-030	42,39	20	97
45606000-130	264,07	1	91	47423000-130	555,06	1	92	50000086-030	6,81	20	98	50001089-033	44,87	20	97
45606000-138	264,07	1	91	47423000-138	555,06	1	92	50000086-033	8,16	20	98	50001089-038	42,44	20	97
45623000-130	300,86	1	91	47601000-130	489,16	1	93	50000086-038	6,95	20	98	50001185-030	20,41	20	97
45623000-138	300,86	1	91	47601000-138	489,16	1	93	50000088-030	4,47	10	99	50001189-030	36,55	20	97
45624000-130	304,76	1	91	47602000-130	496,96	1	93	50000088-038	4,58	10	99	50001841-030	3,93	10	97
45624000-138	304,76	1	91	47602000-138	496,96	1	93	50000089-030	8,10	20	98	50001841-037	3,93	10	97
46401000-130	364,93	1	92	47602240-130	588,45	1	92	50000089-033	9,42	20	98	50002075-030	117,78	5	97
46401000-138	364,93	1	92	47602240-138	588,45	1	92	50000089-038	8,24	20	98	50002075-038	117,90	5	97
46402000-130	372,73	1	92	47603000-130	504,76	1	93	50000181-030	5,13	20	98	50002081-030	17,89	20	97

ARTÍCULO	PRECIO €	PIEZAS CAJA	PÁGINA	ARTÍCULO	PRECIO €	PIEZAS CAJA	PÁGINA	ARTÍCULO	PRECIO €	PIEZAS CAJA	PÁGINA	ARTÍCULO	PRECIO €	PIEZAS CAJA	PÁGINA
50002081-033	18,30	20	97	50010432-038	21,01	10	96	50018085-038	6,14	10	98	51000202-038	46,46	1	94
50002081-038	17,94	20	97	50010472-030	20,61	10	96	50018089-030	8,10	10	98	51000203-030	45,54	1	94
50002085-030	17,79	20	97	50010472-037	20,61	10	96	50018089-033	9,42	10	98	51000203-033	60,85	1	94
50002085-033	18,20	20	97	50010472-038	21,01	10	96	50018089-038	8,24	10	98	51000203-038	46,09	1	94
50002085-038	17,86	20	97	50010800-030	2,88	10	99	50018185-030	3,50	10	98	51000301-030	71,02	1	94
50002086-030	32,50	20	97	50010800-033	3,71	10	99	50018185-033	5,19	10	98	51000301-033	94,05	1	94
50002086-033	33,17	20	97	50010800-038	2,93	10	99	50018185-038	3,56	10	98	51000301-038	72,40	1	94
50002086-038	32,56	20	97	50011041-033	8,55	10	96	50018189-030	4,17	10	99	51000302-030	68,85	1	94
50002089-030	32,40	20	97	50011041-065	7,00	10	96	50018189-033	6,19	10	99	51000302-033	90,82	1	94
50002089-033	33,02	20	97	50011041-072	7,00	10	96	50018189-038	4,26	10	99	51000302-038	69,84	1	94
50002089-038	32,45	20	97	50011075-030	25,06	5	97	50019085-030	5,99	10	98	51000303-030	74,96	1	94
50002185-030	15,42	20	97	50011075-038	25,19	5	97	50019085-038	6,14	10	98	51000303-033	117,22	1	94
50002189-030	28,85	20	97	50011088-030	4,47	10	99	50019089-030	8,10	10	98	51000303-038	76,42	1	94
50002432-039	13,07	10	96, 97	50011088-038	4,58	10	99	50019089-038	8,24	10	98	51000304-030	72,78	1	94
50002472-039	13,07	10	96, 97	50011185-030	3,50	10	98	50019185-030	3,50	10	98	51000305-030	72,82	1	94
50003081-030	20,88	20	97	50011185-038	3,56	10	98	50019185-038	3,56	10	98	51000305-033	95,31	1	94
50003081-033	21,34	20	97	50011189-030	4,17	10	99	50019189-030	4,17	10	99	51000305-038	73,86	1	94
50003081-038	20,92	20	97	50011189-038	4,26	10	99	50019189-038	4,26	10	99	51000307-030	94,11	1	94
50003085-030	20,84	20	97	50011841-030	5,87	10	97	50020185-030	3,50	10	98	51000307-033	115,91	1	94
50003085-033	21,30	20	97	50011841-037	5,87	10	97	50020185-033	5,19	10	98	51000307-038	95,35	1	94
50003085-038	20,91	20	97	50011841-038	6,23	10	97	50020185-038	3,56	10	98	51000308-030	91,94	1	94
50003086-030	38,63	20	97	50012075-030	117,78	5	97	50021186-030	7,28	10	98	51000308-033	112,67	1	94
50003086-033	40,94	20	97	50012075-038	117,90	5	97	51000001-030	17,96	1	99	51000308-038	92,79	1	94
50003086-038	38,68	20	97	50012088-030	2,26	10	99	51000001-033	43,84	1	99	51000309-030	57,45	1	94
50003089-030	38,65	20	97	50012088-033	3,42	10	99	51000001-038	18,33	1	99	51000401-030	97,24	1	94
50003089-033	40,89	20	97	50012088-038	2,34	10	99	51000002-030	23,67	1	99	51000402-030	142,27	1	94
50003089-038	38,69	20	97	50013085-030	5,99	10	98	51000002-033	55,13	1	99	51000403-030	97,24	1	94
50003185-030	18,60	20	97	50013085-033	7,07	10	98	51000002-038	24,15	1	99	51001301-036	133,32	1	95
50003189-030	33,92	20	98	50013085-038	6,14	10	98	51000003-030	31,40	1	99	51001302-036	132,94	1	95
50004081-030	13,34	20	98	50013089-030	8,10	10	98	51000003-033	61,56	1	99	51001401-036	173,83	1	96
50004081-033	13,68	20	98	50013089-033	9,42	10	98	51000003-038	32,02	1	99	51002301-036	142,57	1	96
50004081-038	13,41	20	98	50013089-038	8,24	10	98	51000004-030	38,07	1	99	51002302-036	142,19	1	96
50004085-030	13,27	20	98	50015085-030	5,99	10	98	51000004-033	68,03	1	99	51002401-036	183,57	1	96
50004085-033	13,59	20	98	50015085-038	6,14	10	98	51000004-038	38,80	1	99	51010101-030	9,76	10	99
50004085-038	13,33	20	98	50015089-030	8,10	10	98	51000006-030	50,65	1	99	51010101-033	18,16	10	99
50004086-030	23,41	20	98	50015089-038	8,24	10	98	51000006-033	90,60	1	99	51010101-038	9,97	10	99
50004086-033	23,94	20	98	50015185-030	3,50	10	98	51000006-038	51,68	1	99	51010102-030	15,33	10	99
50004086-038	23,48	20	98	50015185-038	3,56	10	98	51000011-036	48,65	1	103	51010102-033	28,47	10	99
50004089-030	23,36	20	98	50015189-030	4,17	10	99	51000012-036	64,65	1	103	51010102-038	15,65	10	99
50004089-033	24,34	20	98	50015189-038	4,26	10	99	51000013-036	86,07	1	103	51010103-030	19,25	10	99
50004089-038	23,80	20	98	50016085-030	5,99	10	98	51000014-036	104,28	1	103	51010103-033	37,99	10	99
50004185-030	10,93	20	98	50016085-038	6,14	10	98	51000016-036	130,17	1	103	51010103-038	19,63	10	99
50004189-030	19,78	20	98	50016089-030	8,10	10	98	51000111-036	61,99	1	103	51010104-030	22,05	5	100
50010074-030	14,61	10	97	50016089-038	8,24	10	98	51000112-036	77,09	1	103	51010104-033	47,48	5	100
50010074-038	14,92	10	97	50017085-030	5,99	10	98	51000113-036	95,80	1	103	51010104-038	22,46	5	100
50010075-030	26,91	5	97	50017085-033	7,05	10	98	51000114-036	114,52	1	103	51010106-030	28,25	5	100
50010075-038	27,06	5	97	50017085-038	6,14	10	98	51000116-036	136,95	1	103	51010106-033	60,72	5	100
50010076-039	1,98	10	97	50017089-030	8,10	10	98	51000201-030	55,91	1	94	51010106-038	28,79	5	100
50010088-030	2,26	10	99	50017089-033	9,42	10	98	51000201-033	71,33	1	94	51010900-030	2,21	10	99
50010088-038	2,34	10	99	50017089-038	8,24	10	98	51000201-038	56,95	1	94	51020101-039	9,61	1	99
50010432-030	20,61	10	96	50018085-030	5,99	10	98	51000202-030	45,54	1	94	51020102-039	12,80	1	94, 99
50010432-037	20,61	10	96	50018085-033	7,05	10	98	51000202-033	61,92	1	94	51020103-039	16,05	1	94, 99

RELACIÓN NUMÉRICA DE ARTÍCULOS

ÍNDICE GENERAL - RELACIÓN NUMÉRICA POR ARTÍCULO

ARTÍCULO	PRECIO €	PIEZAS CAJA	PÁGINA	ARTÍCULO	PRECIO €	PIEZAS CAJA	PÁGINA	ARTÍCULO	PRECIO €	PIEZAS CAJA	PÁGINA	ARTÍCULO	PRECIO €	PIEZAS CAJA	PÁGINA
51020104-039	20,27	1	94, 99	52050001-035	48,77	1	100	52053202-035	7,66	1	100, 108	52551804-038	15,36	1	102
51020106-039	25,30	1	99	52050001-038	48,77	1	100	52053203-035	9,11	1	100, 108	52551805-030	8,19	1	102
51020701-039	9,31	10	99	52050002-035	61,91	1	100	52053204-035	9,98	1	100, 108	52551805-038	8,34	1	102
51020702-039	12,36	10	99	52050002-036	310,99	1	100	52054101-035	38,36	1	101	52551806-030	9,49	5	102
51020703-039	15,59	10	99	52050002-038	61,91	1	100	52054101-038	38,36	1	101	52551806-038	9,72	5	102
51020704-039	19,55	10	99	52050003-035	72,88	1	100	52054102-035	44,57	1	101	52551807-030	89,02	1	102
51020706-039	24,43	10	99	52050003-036	371,00	1	100	52054102-038	44,57	1	101	52551807-033	89,02	1	102
51020900-030	2,95	10	99	52050003-038	72,88	1	100	52054103-035	50,16	1	101	52554204-030	18,20	1	102
51030900-030	2,65	5	99	52050004-035	81,24	1	100	52054103-038	50,16	1	101	53550101-030	478,68	1	102
51030903-030	11,46	1	99, 100	52050004-036	427,71	1	100	52054104-035	54,72	1	101	53550101-033	478,68	1	102
51030903-033	17,17	1	99, 100	52050004-038	81,24	1	100	52054104-038	54,72	1	101	53550201-030	733,80	1	102
51030903-038	11,68	1	99, 100	52050006-035	101,54	1	100	52054106-035	64,83	1	101	53550201-033	733,80	1	102
51030904-030	15,92	1	99, 100	52050006-038	101,54	1	100	52054106-038	64,83	1	101	53555101-030	72,10	1	102
51030904-033	23,88	1	99, 100	52050101-035	49,57	1	100	52055000-030	11,93	5	93, 101	53555101-033	72,10	1	102
51030904-038	16,25	1	99, 100	52050101-038	49,57	1	100	52055000-033	24,25	5	93, 101	53555102-030	144,10	1	102
51040003-030	35,59	1	99	52050102-035	63,08	1	100	52055000-038	12,17	5	93, 101	53555102-033	144,10	1	102
51040003-033	85,24	1	99	52050102-038	63,08	1	100	52510212-036	108,93	1	103	53555103-030	271,26	1	102
51040003-038	39,83	1	99	52050103-035	74,07	1	100	52510213-036	123,89	1	103	53555103-033	271,26	1	102
51040004-030	42,94	1	99	52050103-038	74,07	1	100	52510214-036	140,89	1	103	53555201-030	114,29	1	102
51040004-033	112,71	1	99	52050104-035	85,11	1	100	52510215-036	160,26	1	103	53555201-033	114,29	1	102
51040004-038	43,78	1	99	52050104-038	85,11	1	100	52510222-036	146,98	1	103	53555202-030	228,57	1	102
51040013-036	74,22	1	103	52050106-035	107,33	1	100	52510223-036	164,43	1	103	53555202-033	228,57	1	102
51040014-036	81,98	1	103	52050106-038	107,33	1	100	52510224-036	187,87	1	103	53555203-030	420,99	1	102
51040103-030	23,40	1	100	52050202-035	60,69	1	100	52513214-036	81,98	1	103	53555203-033	420,99	1	102
51040103-033	61,68	1	100	52050203-035	65,98	1	100	52516301-036	169,26	1	96	55193-31	2,55	50	88
51040103-038	23,88	1	100	52050204-035	71,46	1	100	52516302-036	168,88	1	96	55509-31	1,31	20	88
51040104-030	26,94	1	100	52051801-030	6,02	10	100	52516401-036	208,62	1	96	55510-31	1,53	20	88
51040104-033	69,58	1	100	52051801-038	6,17	10	100	52550112-030	96,44	1	102	55566-31	1,54	50	88
51040104-038	27,47	1	100	52051802-030	9,16	10	100	52550112-033	96,44	1	102	55567-31	4,37	50	88
51040900-033	8,93	1	99, 100	52051802-038	9,36	10	100	52550113-030	107,86	1	102	55572-31	3,28	20	88
51040905-030	1,45	10	99	52051803-030	11,99	10	100	52550113-033	107,86	1	102	55800-31	1,08	50	88
51050002-030	8,37	1	94	52051803-038	12,25	10	100	52550114-030	119,32	1	102	615000**-282	217,00	1	148
51050002-033	16,20	1	94	52051804-030	15,03	5	100	52550114-033	119,32	1	102	615000**-283	217,00	1	148
51050002-038	8,54	1	94	52051804-038	15,33	5	100	52550115-030	130,71	1	102	615000**-284	217,00	1	148
51050003-030	12,20	1	94	52052101-035	31,09	1	101	52550115-033	130,71	1	102	615000**-382	217,00	1	148
51050003-033	23,60	1	94	52052102-035	31,09	1	101	52550204-030	48,46	1	102	615000**-383	217,00	1	148
51050003-038	12,40	1	94	52052103-035	35,04	1	101	52550222-030	133,59	1	102	615000**-384	217,00	1	148
51050004-030	16,04	1	94	52052104-035	40,28	1	101	52550222-033	133,59	1	102	615000**-482	217,00	1	148
52006301-030	119,80	1	95	52052106-035	45,28	1	101	52550223-030	156,95	1	102	615000**-483	217,00	1	148
52006302-030	119,80	1	95	52052203-033	129,23	1	101	52550223-033	156,95	1	102	615000**-484	217,00	1	148
52006305-030	123,79	1	95	52052204-033	133,83	1	101	52550224-030	179,85	1	102	615003**-282	274,00	1	148
52006306-030	120,93	1	95	52052206-033	168,78	1	101	52550224-033	179,85	1	102	615003**-283	274,00	1	148
52006307-030	120,93	1	95	52053101-035	6,33	10	101	52550225-030	202,88	1	102	615003**-284	274,00	1	148
52006310-030	124,92	1	95	52053101-038	6,33	10	101	52550225-033	202,88	1	102	615003**-382	274,00	1	148
52006311-030	90,35	1	95	52053102-035	8,20	10	101	52550900-030	4,00	10	102, 119	615003**-383	274,00	1	148
52006312-030	115,12	1	95	52053102-038	8,20	10	101	52550900-033	9,77	10	102, 119	615003**-384	274,00	1	148
52006313-030	115,12	1	95	52053103-035	9,86	10	101	52550900-038	4,07	10	102, 119	615003**-482	274,00	1	148
52006316-030	119,11	1	95	52053103-038	9,86	10	101	52551801-030	13,68	1	102	615003**-483	274,00	1	148
52006401-030	143,10	1	95	52053104-035	10,78	10	101	52551801-038	13,94	1	102	615003**-484	274,00	1	148
52006402-030	149,29	1	95	52053104-038	10,78	10	101	52551802-030	13,68	1	102	61590038-039	23,00	1	148
52006404-030	154,99	1	95	52053106-035	16,92	10	101	52551802-038	13,94	1	102	62902030-283	94,00	1	149
52006406-030	144,06	1	95	52053106-038	16,92	10	101	52551803-038	11,90	1	102	62902030-284	94,00	1	149

ARTÍCULO	PRECIO €	PIEZAS CAJA	PÁGINA	ARTÍCULO	PRECIO €	PIEZAS CAJA	PÁGINA	ARTÍCULO	PRECIO €	PIEZAS CAJA	PÁGINA	ARTÍCULO	PRECIO €	PIEZAS CAJA	PÁGINA
62902030-383	94,00	1	149	703220**-283	39,00	1	143	704003**-484	85,00	1	144	72060140-884	250,00	1	153
62902030-384	94,00	1	149	703220**-284	39,00	1	143	704219**-039	10,50	1	144	72060340-683	321,00	1	153
62902038-283	94,00	1	149	703220**-482	39,00	1	143	704229**-039	10,50	1	144	72060340-684	321,00	1	153
62902038-284	94,00	1	149	703220**-483	39,00	1	143	704239**-039	9,20	1	144	72060340-688	627,00	1	154
62902038-383	94,00	1	149	703220**-484	39,00	1	143	704249**-039	9,20	1	144	72060340-883	256,00	1	153
62902038-384	94,00	1	149	703223**-282	58,00	1	143	704289**-039	11,80	1	144	72060340-884	256,00	1	153
640100**-283	185,00	1	145	703223**-283	58,00	1	143	70730130-683	94,00	1	152	72060340-888	578,00	1	154
640100**-284	185,00	1	145	703223**-284	58,00	1	143	70730130-684	94,00	1	152	72061040-683	273,00	1	153
640100**-293	197,00	1	145	703223**-482	58,00	1	143	70730133-683	94,00	1	152	72061040-684	273,00	1	153
640100**-483	185,00	1	145	703223**-483	58,00	1	143	70730133-684	94,00	1	152	72061040-883	208,00	1	153
640100**-484	185,00	1	145	703223**-484	58,00	1	143	70731130-883	108,00	1	152	72061040-884	208,00	1	153
640100**-493	197,00	1	145	703230**-282	37,50	1	143	70731130-884	108,00	1	152	72061140-683	309,00	1	153
640300**-483	209,00	1	146	703230**-283	37,50	1	143	70731133-883	108,00	1	152	72061140-684	309,00	1	153
640300**-484	209,00	1	146	703230**-284	37,50	1	143	70731133-884	108,00	1	152	72061140-883	268,00	1	153
640300**-493	249,00	1	146	703230**-482	37,50	1	143	71211030-992	108,00	1	145	72061140-884	268,00	1	153
640310**-283	174,00	1	146	703230**-483	37,50	1	143	71211030-993	108,00	1	145	72061340-683	339,00	1	153
640310**-284	174,00	1	146	703230**-484	37,50	1	143	71211330-992	123,00	1	146	72061340-684	339,00	1	153
640310**-293	214,00	1	146	703233**-282	57,00	1	143	71211330-993	123,00	1	146	72061340-688	646,00	1	154
640310**-483	174,00	1	146	703233**-283	57,00	1	143	71212030-992	138,00	1	145	72061340-883	273,00	1	153
640310**-484	174,00	1	146	703233**-284	57,00	1	143	71212030-993	138,00	1	145	72061340-884	273,00	1	153
640310**-493	214,00	1	146	703233**-482	57,00	1	143	71212330-992	153,00	1	146	72095030-039	51,00	1	154
640320**-283	128,00	1	146	703233**-483	57,00	1	143	71212330-993	153,00	1	146	72095130-039	62,50	1	154
640320**-284	128,00	1	146	703233**-484	57,00	1	143	71221030-992	128,00	1	145	72095530-039	44,00	1	154
640320**-293	168,00	1	146	703240**-282	37,50	1	143	71221030-993	128,00	1	145	72095630-039	79,50	1	154
640901**-039	18,00	1	146	703240**-283	37,50	1	143	71221330-992	143,00	1	146	72095730-039	91,00	1	154
640902**-039	18,00	1	146	703240**-284	37,50	1	143	71221330-993	143,00	1	146	72095830-039	34,00	1	154
640903**-039	18,00	1	146	703240**-482	37,50	1	143	71222030-992	158,00	1	145	72096230-039	61,00	1	154
65004030-293	150,00	1	147	703240**-483	37,50	1	143	71222030-993	158,00	1	145	72096430-039	71,00	1	154
65004030-294	150,00	1	147	703240**-484	37,50	1	143	71222330-992	173,00	1	146	72524030-883	66,00	1	145
65004030-393	150,00	1	147	703243**-282	57,00	1	143	71222330-993	173,00	1	146	72524030-884	66,00	1	145
65004030-394	150,00	1	147	703243**-283	57,00	1	143	71291938-039	14,00	1	146	72524130-883	102,00	1	145
65004030-493	150,00	1	147	703243**-284	57,00	1	143	71292938-039	17,00	1	146	72524130-884	102,00	1	145
65004030-494	150,00	1	147	703243**-482	57,00	1	143	71640138-784	234,00	1	156	72524330-883	124,00	1	145
65004038-293	150,00	1	147	703243**-483	57,00	1	143	71641138-784	282,00	1	156	72524330-884	124,00	1	145
65004038-294	150,00	1	147	703243**-484	57,00	1	143	71642138-784	340,00	1	156	72525030-883	105,50	1	145
65004038-393	150,00	1	147	703250**-482	58,50	1	144	71730030-983	90,00	1	153	72525030-884	105,50	1	145
65004038-394	150,00	1	147	703250**-483	58,50	1	144	71730030-984	90,00	1	153	72525130-883	140,50	1	145
65004038-493	150,00	1	147	703250**-484	58,50	1	144	71730530-983	136,00	1	153	72525130-884	140,50	1	145
65004038-494	150,00	1	147	703253**-482	77,50	1	144	71730530-984	136,00	1	153	72525330-883	161,50	1	145
703210**-282	39,00	1	143	703253**-483	77,50	1	144	71921030-983	10,40	1	146	72525330-884	161,50	1	145
703210**-283	39,00	1	143	703253**-484	77,50	1	144	71921030-984	10,40	1	146	72526030-883	39,00	1	145
703210**-284	39,00	1	143	704000**-282	47,00	1	144	71921030-986	10,40	1	146	72526030-884	39,00	1	145
703210**-482	39,00	1	143	704000**-283	47,00	1	144	71922030-983	17,30	1	146	72526130-883	75,00	1	145
703210**-483	39,00	1	143	704000**-284	47,00	1	144	71922030-984	17,30	1	146	72526130-884	75,00	1	145
703210**-484	39,00	1	143	704000**-482	47,00	1	144	71922030-986	17,30	1	146	72526330-883	97,00	1	145
703213**-282	58,00	1	143	704000**-483	47,00	1	144	72060040-683	256,00	1	153	72526330-884	97,00	1	145
703213**-283	58,00	1	143	704000**-484	47,00	1	144	72060040-684	256,00	1	153	72534030-039	27,00	1	145
703213**-284	58,00	1	143	704003**-282	85,00	1	144	72060040-883	184,00	1	153	72536030-039	20,00	1	145
703213**-482	58,00	1	143	704003**-283	85,00	1	144	72060040-884	184,00	1	153	72661033-884	89,00	1	154
703213**-483	58,00	1	143	704003**-284	85,00	1	144	72060140-683	291,00	1	153	72661133-884	115,00	1	154
703213**-484	58,00	1	143	704003**-482	85,00	1	144	72060140-684	291,00	1	153	72661333-884	130,50	1	154
703220**-282	39,00	1	143	704003**-483	85,00	1	144	72060140-883	250,00	1	153	72670033-683	58,00	1	154

RELACIÓN NUMÉRICA DE ARTÍCULOS

ÍNDICE GENERAL - RELACIÓN NUMÉRICA POR ARTÍCULO

ARTÍCULO	PRECIO €	PIEZAS CAJA	PÁGINA	ARTÍCULO	PRECIO €	PIEZAS CAJA	PÁGINA	ARTÍCULO	PRECIO €	PIEZAS CAJA	PÁGINA	ARTÍCULO	PRECIO €	PIEZAS CAJA	PÁGINA
72670033-684	58,00	1	154	73026-63	8,21	5	68	73620-62	8,89	5	68	75012-30	3,14	5	69
72670033-685	58,00	1	154	73040-60	2,89	10	68	73620-63	15,51	5	68	75012-31	3,22	5	69
72670033-883	50,00	1	154	73040-62	3,54	5	68	73621-60	6,92	5	68	7501313-039	84,28	1	69
72670033-884	50,00	1	154	73040-63	10,04	5	68	73621-62	8,89	5	68	7501432-039	50,38	1	69
72670033-885	50,00	1	154	73041-60	4,79	10	68	73621-63	15,51	5	68	75016-30	3,35	20	69
72670133-884	75,00	1	154	73041-62	5,84	5	68	73630-60	10,04	5	68	75016-31	3,45	20	69
72670333-683	108,00	1	154	73041-63	10,86	5	68	73630-62	12,92	5	68	75017-30	3,03	20	69
72670333-684	108,00	1	154	73041-67	6,71	10	68	73630-63	21,33	5	68	75017-31	3,11	20	69
72670333-685	108,00	1	154	73068-60	5,83	10	68	73631-60	10,04	5	68	75018-30	3,03	10	69
72670333-883	97,00	1	154	73068-62	7,11	5	68	73631-62	12,92	5	68	75018-31	3,11	5	69
72695230-039	45,00	1	154	73068-63	13,35	5	68	73631-63	21,33	5	68	7502251-039	37,07	10	69
72695430-039	55,50	1	154	73085-60	10,71	10	68	73800-60	5,47	10	68	7502313-039	84,28	1	69
72697000-039	26,00	1	154	73085-62	14,27	5	68	73800-62	7,31	5	68	7502393-039	34,74	10	69
72697030-039	6,00	1	154	73085-63	27,33	5	68	73800-63	13,99	5	68	7502394-039	35,46	10	69
72950033-683	45,00	1	155	73086-60	11,53	10	68	73805-60	6,40	5	68	75026-30	4,51	20	70
72950033-684	45,00	1	155	73086-62	15,29	5	68	73805-63	14,89	5	68	75026-31	4,63	20	70
72950033-685	45,00	1	155	73086-63	29,18	5	68	740010**-283	135,50	1	149	75027-30	4,61	5	70
72950033-883	35,00	1	155	73097-60	3,54	10	68	740010**-284	135,50	1	149	75027-31	4,73	5	70
72950033-884	35,00	1	155	73097-62	4,32	5	68	740010**-383	135,50	1	149	75028-30	4,80	20	70
72950033-885	35,00	1	155	73097-63	8,21	5	68	740010**-384	135,50	1	149	75028-31	4,93	20	70
72950333-683	70,00	1	155	73101-39	4,56	10	68	740010**-483	135,50	1	149	75031-30	3,50	10	70
72950333-684	70,00	1	155	73150-39	5,25	10	68	740010**-484	135,50	1	149	75031-31	3,60	5	70
72950333-685	70,00	1	155	73150-50	12,35	10	67	740013**-283	271,50	1	149	75032-30	3,68	5	70
72950530-039	41,00	1	155	73150-53	21,09	5	67	740013**-383	271,50	1	149	75032-31	3,78	5	70
72950730-039	45,00	1	155	73160-39	9,48	10	68	740013**-483	271,50	1	149	75033-30	4,80	10	70
72951033-683	75,00	1	155	73201-39	5,29	10	68	7500091-039	49,08	1	69	75033-31	4,93	10	70
72951033-684	75,00	1	155	73201-50	9,13	10	67	7500092-039	66,13	1	69	75035-30	16,95	5	70
72951033-685	75,00	1	155	73201-53	20,42	5	67	75001-39	0,86	25	69	75035-31	17,42	5	70
72951033-883	60,00	1	155	73251-39	12,87	10	68	75002-39	0,87	25	69	75040-60	4,37	10	70
72951033-884	60,00	1	155	73396-39	11,37	10	68	75003-39	0,88	25	69	75041-60	4,37	10	70
72951033-885	60,00	1	155	73398-39	10,79	10	68	7500313-039	60,71	5	69	75041-61	4,49	10	70
72951333-683	100,00	1	155	73431-39	3,60	20	68	7500316-039	66,41	5	69	75051-30	3,72	10	70
72951333-684	100,00	1	155	73431-50	9,22	10	67	75004-39	0,88	25	69	75051-31	3,82	10	70
72951333-685	100,00	1	155	73431-53	22,41	5	67	7500422-039	8,73	10	69	75052-30	3,67	5	70
72951630-039	53,50	1	155	73432-39	3,95	10	68	7500520-039	159,73	1	69	75052-31	3,77	5	70
72951830-039	55,00	1	155	73432-50	11,48	10	67	7500521-039	159,73	1	69	75053-30	3,58	20	70
72992000-039	24,00	1	155	73432-53	23,06	5	67	7500522-039	160,87	1	69	75053-31	3,68	20	70
72992030-039	5,50	1	155	73433-50	29,02	5	67	7500523-039	160,87	1	69	75054-30	7,17	10	70
73010-60	2,02	10	68	73458-39	7,36	10	68	7500526-039	21,81	5	69	75054-31	7,36	10	70
73010-62	4,32	5	68	73480-60	11,91	10	68	7500545-030	13,98	5	69	75062-30	3,82	20	70
73010-63	6,92	5	68	73480-62	14,60	5	68	7500545-031	14,37	5	69	75062-31	3,92	20	70
73016-60	3,54	10	68	73486-69	19,03	10	68	7500546-039	35,23	1	69	75065-30	4,07	5	70
73016-62	4,32	5	68	73487-69	19,03	10	68	7500550-039	23,12	5	69	75065-31	4,18	5	70
73016-63	8,21	5	68	73488-69	19,03	10	68	7500999-039	9,80	10	69	75065-32	4,25	5	70
73017-60	2,84	10	68	73585-60	17,14	10	68	75010-30	3,03	20	69	75080-30	3,13	5	70
73017-62	3,49	5	68	73585-62	23,05	5	68	75010-31	3,11	20	69	75080-31	3,21	5	70
73017-63	6,67	5	68	73593-60	10,94	10	68	7501090-039	37,33	1	69	75088-30	4,61	10	70
73018-60	2,84	10	68	73593-62	14,65	5	68	7501092-039	37,06	1	69	75088-31	4,73	10	70
73018-62	3,49	5	68	73610-60	3,57	10	68	7501094-039	33,95	1	69	75090-60	12,77	5	70
73018-63	6,67	5	68	73610-62	4,06	5	68	7501095-039	47,01	1	69	75090-61	13,13	5	70
73026-60	3,54	10	68	73610-63	9,35	5	68	75011-30	3,14	20	69	75097-30	3,58	20	70
73026-62	4,32	5	68	73620-60	6,92	5	68	75011-31	3,22	20	69	75097-31	3,68	20	70

ARTÍCULO	PRECIO €	PIEZAS CAJA	PÁGINA	ARTÍCULO	PRECIO €	PIEZAS CAJA	PÁGINA	ARTÍCULO	PRECIO €	PIEZAS CAJA	PÁGINA	ARTÍCULO	PRECIO €	PIEZAS CAJA	PÁGINA
75101-39	8,36	10	68	75432-69	7,01	10	78	75800-30	8,40	10	70	8000100-039	93,07	1	84
75102-39	21,18	10	68	75458-39	9,86	10	69	75800-31	8,63	10	70	8000611-030	74,75	1	84
75104-39	17,40	10	68	75464-39	6,39	10	69	75801-39	11,25	10	69	8000611-038	74,75	1	84
7511094-039	75,05	1	69	75464-69	7,08	10	78	75802-31	10,83	10	78	8000611-093	74,75	1	84
7511095-039	72,21	1	69	75466-69	18,97	10	69	75802-39	7,41	10	69	8000621-030	87,43	1	84
7511096-039	47,85	1	69	75467-69	18,97	10	69	75803-39	7,41	10	69	8000621-038	87,43	1	84
7511296-039 ^b	53,92	1	69	75468-69	18,97	10	69	75804-39	65,37	1	69	8000621-090	87,43	1	84
7511432-039 ^b	59,22	1	69	75480-30	12,90	10	69	75805-39	49,23	1	69	8000621-093	87,43	1	84
75133-39	17,72	10	68	75480-31	13,26	10	69	75806-39	27,35	10	69	8000621-096	87,43	1	84
75134-39	25,54	10	68	75480-32	13,42	10	69	75809-39	100,38	1	69	8000621-098	87,43	1	84
75134-69	19,05	5	78	75481-30	15,60	10	69	75900-39	2,28	20	70	8000641-030	97,85	1	84
75150-39	9,58	10	68	75481-31	16,03	10	69	75901-39	2,77	20	70	8000641-038	97,85	1	84
75150-69	10,23	10	78	75481-32	16,38	10	69	75902-39	2,77	20	70	8000641-090	97,85	1	84
75152-39	9,43	10	68	75486-39	15,46	10	69	75903-39	2,77	20	70	8000641-093	97,85	1	84
75160-39	18,07	10	68	75487-39	15,46	10	69	75904-39	2,77	20	70	8000641-096	97,85	1	84
75201-39	10,05	10	68	75488-39	15,46	10	69	75905-39	2,77	20	70	8000641-098	97,85	1	84
75202-39	22,86	10	68	75500-39	89,78	1	69	75906-39	8,55	20	70	8000651-030	268,69	1	84
75203-39	27,91	10	68	75503-39	103,02	1	69	75907-39	2,77	20	70	8000651-038	268,69	1	84
75204-39	19,36	10	68	75528-39	21,68	5	69	75908-39	2,77	20	70	8000651-093	268,69	1	84
75211-39	11,74	10	68	75540-39	21,49	5	69	75909-39	2,53	20	70	8000661-030	107,00	1	84
75211-69	11,03	10	78	75541-39	35,39	5	69	75910-39	2,28	20	70	8000661-038	107,00	1	84
7521432-039 ^b	68,22	1	69	75542-30	37,12	10	69	75911-39	8,04	20	70	8000661-090	107,00	1	84
75233-39	24,11	10	68	75542-31	37,84	10	69	75912-39	2,77	20	70	8000661-093	107,00	1	84
75251-39	21,38	10	68	75542-32	39,16	10	69	75913-39	2,53	20	70	8000661-096	107,00	1	84
75253-69	23,59	5	78	75542-37	39,16	10	69	75918-39	2,82	20	70	8000661-098	107,00	1	84
75254-39	32,45	10	68	75544-39	24,30	5	69	7700101-039	8,52	10	69	8000671-030	272,59	1	84
75301-39	23,81	10	68	75552-39	20,24	10	69	7700112-039	21,46	5	69	8000671-038	272,59	1	84
75305-69	117,36	1	68	75553-39	19,86	10	69	7700150-039	9,77	10	69	8000671-093	272,59	1	84
75306-69	40,27	1	68	75558-39	73,70	1	69	7700160-039	18,42	10	69	8000700-030	67,45	1	84
75311-39	56,54	1	68	75585-60	13,62	5	70	7700201-039	10,24	10	69	8000700-038	67,45	1	84
75312-39	221,01	1	68	75585-61	14,00	5	70	7700211-039	11,54	5	69	8000700-093	67,45	1	84
75317-39	128,68	1	68	75589-60	14,03	5	70	7700251-039	21,79	10	69	8000701-039	3,82	1	84
75319-39	138,45	1	68	75589-61	14,42	5	70	7700802-037	10,27	5	69	8000800-039	332,33	1	87
75322-69	119,41	1	68	75610-30	3,87	10	70	7700802-064	10,27	5	69	80021030-683	75,00	1	144
75325-39	81,08	1	68	75610-31	3,98	10	70	78036033-884	69,50	1	156	80021030-684	75,00	1	144
75331-39	30,08	10	68	75620-30	6,24	10	70	78036033-885	69,50	1	156	80021330-683	90,00	1	144
75333-39	28,20	10	68	75620-31	6,41	10	70	78036133-884	116,50	1	156	80021330-684	90,00	1	144
75343-39	138,01	1	68	75630-30	11,60	10	70	78036133-885	116,50	1	156	80022030-683	90,00	1	144
75350-69	108,06	1	68	75630-31	11,93	10	70	78036333-884	188,50	1	156	80022030-684	90,00	1	144
75358-39	130,58	1	68	75640-30	16,93	10	70	78036333-885	188,50	1	156	80022330-683	105,00	1	144
75370-39	78,38	1	68	75640-31	17,40	10	70	78037033-884	86,50	1	156	80022330-684	105,00	1	144
75393-39	33,93	10	69	75750-30	7,02	10	70	78037033-885	86,50	1	156	80023030-683	105,00	1	144
75394-39	35,46	10	69	75750-31	7,22	10	70	78037133-884	134,50	1	156	80023030-684	105,00	1	144
75395-39	18,55	10	69	75750-32	7,84	10	70	78037133-885	134,50	1	156	80023330-683	120,00	1	144
75396-39	18,55	10	69	75751-30	7,31	10	70	78037333-884	218,50	1	156	80023330-684	120,00	1	144
75396-69	19,82	5	78	75751-31	7,51	10	70	78037333-885	218,50	1	156	80024030-283	114,00	1	144
75397-39	24,38	10	69	75751-32	8,21	10	70	78038033-884	98,50	1	156	80024030-284	114,00	1	144
75398-39	18,55	10	69	75760-30	12,03	5	70	78038033-885	98,50	1	156	80024330-283	129,00	1	144
75399-39	22,19	10	69	75760-32	13,53	5	70	78038133-884	188,50	1	156	80024330-284	129,00	1	144
75423-39	8,73	10	69	75761-30	12,60	5	70	78038133-885	188,50	1	156	80071900-039	9,00	1	144
75431-39	6,69	10	69	75761-31	12,95	5	70	78038333-884	248,50	1	156	80072900-039	12,00	1	144
75432-39	6,43	10	69	75761-32	14,16	5	70	78038333-885	248,50	1	156	80073900-039	15,00	1	144

RELACIÓN NUMÉRICA DE ARTÍCULOS

ÍNDICE GENERAL - RELACIÓN NUMÉRICA POR ARTÍCULO

ARTÍCULO	PRECIO €	PIEZAS CAJA	PÁGINA	ARTÍCULO	PRECIO €	PIEZAS CAJA	PÁGINA	ARTÍCULO	PRECIO €	PIEZAS CAJA	PÁGINA	ARTÍCULO	PRECIO €	PIEZAS CAJA	PÁGINA
80081938-039	11,00	1	144	81034000-920	130,50	1	139	81062100-982	204,50	1	138	81202133-039	25,00	1	139
80082938-039	14,00	1	144	81034000-940	130,50	1	139	81062100-983	204,50	1	138	81202233-039	34,00	1	140
80083938-039	17,00	1	144	81034000-982	119,50	1	138	81062100-984	204,50	1	138	81202310-039	51,50	1	141
80091930-039	9,00	1	144	81034000-983	119,50	1	138	81062100-986	204,50	1	138	81208030-039	37,50	1	140
80092930-039	12,00	1	144	81034000-984	119,50	1	138	81086000-982	124,00	1	138	81208060-039	42,50	1	140
80093930-039	15,00	1	144	81034000-986	119,50	1	138	81086000-983	124,00	1	138	81210010-039	9,80	1	139
81020-38	189,59	1	87	81034100-982	134,50	1	138	81086000-984	124,00	1	138	81210012-039	9,80	1	139
81023000-982	34,00	1	138	81034100-983	134,50	1	138	81086100-982	140,00	1	138	81210110-039	9,00	1	139, 140
81023000-983	34,00	1	138	81034100-984	134,50	1	138	81086100-983	140,00	1	138	81210112-039	9,00	1	139, 140
81023000-984	34,00	1	138	81034100-986	134,50	1	138	81086100-984	140,00	1	138	81210210-039	8,90	1	140, 141
81023020-982	131,00	1	138	81035000-992	90,50	1	138	81090024-139	16,00	1	141	81210213-039	11,00	1	140
81023020-983	131,00	1	138	81035000-993	90,50	1	138	81090035-139	29,50	1	141	81210611-039	9,00	1	140
81023020-984	131,00	1	138	81035000-994	90,50	1	138	81090060-139	36,00	1	141	81210811-039	11,50	1	141
81023100-982	45,00	1	138	81035000-996	90,50	1	138	81090070-139	56,50	1	141	81210910-039	7,50	1	140
81023100-983	45,00	1	138	81035100-992	104,50	1	138	81090150-139	96,00	1	141	81211510-039	13,80	1	141
81023100-984	45,00	1	138	81035100-993	104,50	1	138	81090250-139	130,00	1	141	81211610-039	7,50	1	139, 140
81025000-982	45,00	1	138	81035100-994	104,50	1	138	81091025-039	60,00	1	141	81211910-039	9,00	1	139, 140
81025000-983	45,00	1	138	81035100-996	104,50	1	138	81091065-039	74,50	1	141	81212210-039	12,50	1	140
81025000-984	45,00	1	138	81036000-800	141,00	1	139	81091075-039	84,50	1	141	812124-39	11,38	5	88
81025020-982	176,00	1	138	81036000-900	136,50	1	139	81091150-039	135,50	1	141	81220000-039	1,20	1	139
81025020-983	176,00	1	138	81036000-992	104,00	1	138	81091240-039	169,00	1	141	81220038-039	1,20	1	139
81025020-984	176,00	1	138	81036000-993	104,00	1	138	81093060-039	108,50	1	141	81220100-039	1,20	1	139
81025100-982	62,00	1	138	81036000-994	104,00	1	138	81093150-039	169,00	1	141	81220130-039	1,30	1	139
81025100-983	62,00	1	138	81036000-996	104,00	1	138	81095300-039	73,50	1	141	81220138-039	1,30	1	139
81025100-984	62,00	1	138	81036100-800	155,00	1	139	81095400-039	124,00	1	141	81220200-039	1,20	1	140
81026000-982	56,50	1	138	81036100-900	157,00	1	139	81095500-039	158,00	1	141	81220500-039	1,60	1	141
81026000-983	56,50	1	138	81036100-992	118,50	1	138	81200033-039	19,00	1	139	81220538-039	1,70	1	141
81026000-984	56,50	1	138	81036100-993	118,50	1	138	81200038-039	24,00	1	139	81220600-039	1,20	1	140
81026020-982	221,00	1	138	81036100-994	118,50	1	138	81200130-039	22,50	1	139	81220800-039	2,00	1	141
81026020-983	221,00	1	138	81036100-996	118,50	1	138	81200133-039	18,50	1	139	81220830-039	2,30	1	141
81026020-984	221,00	1	138	81037000-902	160,50	1	139	81200138-039	20,50	1	139	81220838-039	2,30	1	141
81026100-982	70,50	1	138	81037100-902	177,50	1	139	81200233-039	27,50	1	140	81220900-039	2,50	1	140
81026100-983	70,50	1	138	81038000-992	127,50	1	138	81200533-039	27,00	1	141	81220930-039	2,90	1	140
81026100-984	70,50	1	138	81038000-993	127,50	1	138	81200538-039	29,00	1	141	81221500-039	2,70	1	141
81028000-982	90,50	1	138	81038000-994	127,50	1	138	81200633-039	16,00	1	140	81221633-039	1,30	1	140
81028000-983	90,50	1	138	81038000-996	127,50	1	138	81200830-039	64,50	1	141	81221638-039	1,30	1	140
81028000-984	90,50	1	138	81038100-992	143,50	1	138	81200833-039	60,00	1	141	81221733-039	1,30	1	139
81028020-982	356,50	1	138	81038100-993	143,50	1	138	81200838-039	64,50	1	141	81221738-039	1,20	1	139
81028020-983	356,50	1	138	81038100-994	143,50	1	138	81200930-039	56,50	1	140	81221830-040	1,30	1	140
81028020-984	356,50	1	138	81038100-996	143,50	1	138	81200933-039	52,50	1	140	81221833-039	1,20	1	140
81028100-982	104,50	1	138	81042000-982	127,00	1	138	81201533-039	22,50	1	141	81221838-041	1,30	1	140
81028100-983	104,50	1	138	81042000-983	127,00	1	138	81201633-039	9,40	1	140	81221930-039	1,30	1	139
81028100-984	104,50	1	138	81042000-984	127,00	1	138	81201638-039	13,50	1	140	81221933-039	1,20	1	139
81033000-992	51,00	1	138	81042000-986	127,00	1	138	81201733-039	9,10	1	139	81221938-039	1,30	1	139
81033000-993	51,00	1	138	81052000-982	160,00	1	139	81201738-039	12,00	1	139	81222-38	56,11	1	87
81033000-994	51,00	1	138	81052000-983	160,00	1	139	81201830-039	15,50	1	140	81222000-039	1,20	1	140
81033000-996	51,00	1	138	81052000-984	160,00	1	139	81201833-039	11,50	1	140	81222100-039	1,20	1	139
81033100-992	65,00	1	138	81052000-986	160,00	1	139	81201838-039	12,50	1	140	81222200-039	2,00	1	140
81033100-993	65,00	1	138	81062000-982	179,50	1	138	81201930-039	15,50	1	139	81222300-039	8,30	1	141
81033100-994	65,00	1	138	81062000-983	179,50	1	138	81201933-039	11,50	1	139	81228000-039	2,10	1	140
81033100-996	65,00	1	138	81062000-984	179,50	1	138	81201938-039	12,50	1	139	81228020-039	2,10	1	140
81034000-910	130,50	1	139	81062000-986	179,50	1	138	81202033-039	37,00	1	140	81230000-039	1,20	1	139

ARTÍCULO	PRECIO €	PIEZAS CAJA	PÁGINA	ARTÍCULO	PRECIO €	PIEZAS CAJA	PÁGINA	ARTÍCULO	PRECIO €	PIEZAS CAJA	PÁGINA	ARTÍCULO	PRECIO €	PIEZAS CAJA	PÁGINA
81230038-039	1,20	1	139	81641338-784	512,00	1	155	8200016-030	5,72	10	77	8200050-034	8,24	5	71
81230100-039	1,20	1	139	81641338-785	512,00	1	155	8200016-031	5,89	10	77	8200050-038	6,47	5	71
81230130-039	1,30	1	139	81643038-384	474,00	1	155	8200016-033	7,90	5	77	8200050-090	5,70	5	71
81230138-039	1,30	1	139	81643038-385	474,00	1	155	8200016-034	7,90	5	77	8200050-093	7,47	5	71
81230200-039	1,20	1	140	81643038-784	474,00	1	155	8200016-038	6,16	5	77	8200050-094	7,47	5	71
81230500-039	1,60	1	141	81643038-785	474,00	1	155	8200016-090	5,18	10	71	8200050-096	7,87	5	71
81230538-039	1,70	1	141	81643338-384	607,00	1	155	8200016-093	6,92	5	77	8200050-098	6,04	5	71
81230600-039	1,20	1	140	81643338-385	607,00	1	155	8200016-094	6,85	10	71	8200051-090	5,19	10	71
81231633-039	1,30	1	140	81643338-784	607,00	1	155	8200016-096	7,26	10	71	8200051-094	6,76	10	71
81231638-039	1,30	1	140	81643338-785	607,00	1	155	8200016-098	5,61	10	71	8200051-096	7,28	10	71
81231733-039	1,30	1	139	81644038-384	533,00	1	155	8200017-090	4,59	10	71	8200051-098	5,62	10	71
81231738-039	1,20	1	139	81644038-385	533,00	1	155	8200017-094	5,57	10	71	8200052-090	5,94	5	71
81231830-040	1,30	1	140	81644038-784	533,00	1	155	8200017-096	6,40	10	71	8200052-094	7,60	5	71
81231833-039	1,20	1	140	81644038-785	533,00	1	155	8200017-098	4,93	10	71	8200052-096	7,82	5	71
81231838-041	1,30	1	140	81644338-384	666,00	1	155	8200026-090	5,93	10	71	8200052-098	6,38	5	71
81231930-039	1,30	1	139	81644338-385	666,00	1	155	8200026-094	6,87	10	71	8200053-090	5,20	20	71
81231933-039	1,20	1	139	81644338-784	666,00	1	155	8200026-096	6,94	10	71	8200053-094	6,11	10	71
81231938-039	1,30	1	139	81644338-785	666,00	1	155	8200026-098	6,39	10	71	8200053-096	6,86	20	71
81232000-039	1,20	1	140	81860-39	94,53	1	88	8200028-090	5,85	20	71	8200053-098	5,60	20	71
81232200-039	2,00	1	140	81861-39	110,23	1	88	8200028-094	7,67	10	71	8200054-090	7,86	5	71
81238000-039	2,10	1	140	81862-39	108,58	1	88	8200028-096	8,20	20	71	8200054-094	10,33	5	71
81238020-039	2,10	1	140	81864-39	24,12	1	88	8200028-098	6,31	20	71	8200054-096	11,01	5	71
81270000-239	6,80	1	139	8200005-090	12,30	5	71	8200029-090	6,17	5	71	8200054-098	8,47	5	71
81270100-139	1,20	1	139	8200005-094	13,86	5	71	8200029-094	8,10	10	71	8200057-030	5,92	5	77
81270200-139	1,20	1	140	8200005-096	16,21	5	71	8200029-096	8,65	5	71	8200057-031	6,09	5	77
81270500-539	6,60	1	141	8200005-098	13,30	5	71	8200029-098	6,68	5	71	8200057-033	8,76	5	77
81270500-639	8,30	1	141	8200006-090	12,40	5	71	8200033-090	6,17	10	71	8200057-034	8,79	5	77
81270600-139	1,20	1	140	8200006-094	14,08	5	71	8200033-094	7,80	10	71	8200057-038	6,33	5	77
81270800-339	14,50	1	141	8200006-096	16,46	5	71	8200033-096	8,65	10	71	8200057-093	7,67	5	77
81271500-039	7,60	1	141	8200006-098	13,50	5	71	8200033-098	6,68	10	71	8200061-030	6,12	5	72
81271700-139	1,20	1	139, 140	8200010-090	4,22	20	71	8200041-090	4,84	10	71	8200061-031	6,30	5	72
81272100-139	1,20	1	139	8200010-094	4,77	20	71	8200041-094	6,46	10	71	8200061-033	8,24	5	72
81272300-039	7,50	1	141	8200010-096	6,13	20	71	8200041-096	8,16	10	71	8200061-034	8,24	5	72
81272300-139	2,30	1	141	8200010-098	4,63	20	71	8200041-098	5,50	10	71	8200061-038	6,47	5	72
81272330-339	19,50	1	141	8200011-030	5,36	20	77	8200046-030	5,14	5	77	8200061-090	5,70	5	72
81272338-339	19,50	1	141	8200011-031	5,52	20	77	8200046-031	5,24	5	77	8200061-093	7,47	5	72
81278030-139	1,20	1	140	8200011-033	7,48	20	77	8200046-033	7,49	5	77	8200061-094	7,47	5	72
81278060-139	1,70	1	140	8200011-034	7,48	20	77	8200046-038	5,67	5	77	8200061-096	7,87	5	72
81640038-384	262,00	1	155	8200011-038	5,87	20	77	8200046-093	6,83	5	77	8200061-098	6,04	5	72
81640038-385	262,00	1	155	8200011-093	6,55	20	72, 77	8200049-030	6,12	5	77	8200062-090	5,04	20	72
81640038-784	262,00	1	155	8200013-030	5,10	5	77	8200049-031	6,30	5	77	8200062-094*	7,15	20	72
81640038-785	262,00	1	155	8200013-031	5,25	5	77	8200049-033	8,24	5	77	8200062-096	7,09	20	72
81640338-384	369,00	1	155	8200013-033	7,06	5	77	8200049-034	8,24	5	77	8200062-098	5,45	20	72
81640338-385	369,00	1	155	8200013-034	7,06	5	77	8200049-038	6,47	5	77	8200071-030	24,72	1	85
81640338-784	369,00	1	155	8200013-038	5,51	5	77	8200049-090	5,70	5	71	8200071-038	26,08	1	85
81640338-785	369,00	1	155	8200013-093	6,17	5	77	8200049-093	7,47	5	71, 77	8200071-093	25,87	1	85
81641038-384	393,00	1	155	8200015-030	5,72	5	77	8200049-094	7,47	10	71	8200078-060	10,57	5	77
81641038-385	393,00	1	155	8200015-031	5,89	5	77	8200049-096	7,87	5	71	8200078-061	10,88	5	77
81641038-784	393,00	1	155	8200015-033	7,90	5	77	8200049-098	6,04	5	71	8200078-063	13,59	5	77
81641038-785	393,00	1	155	8200015-034	7,90	5	77	8200050-030	6,12	5	71	8200078-064	13,83	5	77
81641338-384	512,00	1	155	8200015-038	6,16	5	77	8200050-031	6,30	5	71	8200078-068	11,57	5	77
81641338-385	512,00	1	155	8200015-093	6,92	5	77	8200050-033	8,24	5	71	8200078-090	10,57	5	72

RELACIÓN NUMÉRICA DE ARTÍCULOS

ÍNDICE GENERAL - RELACIÓN NUMÉRICA POR ARTÍCULO

ARTÍCULO	PRECIO €	PIEZAS CAJA	PÁGINA	ARTÍCULO	PRECIO €	PIEZAS CAJA	PÁGINA	ARTÍCULO	PRECIO €	PIEZAS CAJA	PÁGINA	ARTÍCULO	PRECIO €	PIEZAS CAJA	PÁGINA
8200078-093	12,13	5	77	8200397-096	30,26	5	71	8200617-092	5,46	10	70	8200640-296	34,66	1	72
8200078-094	11,89	5	72	8200397-098	29,84	5	71	8200617-093	7,43	5	70	8200647-090	10,27	5	70
8200078-096	14,85	5	72	8200398-030	23,43	5	75	8200617-094	7,43	5	70	8200647-092	19,12	5	70
8200078-098	11,42	5	72	8200398-038	23,99	5	75	8200617-095	8,03	5	70	8200647-093	25,66	1	70
8200089-030	6,80	1	77	8200398-090	23,43	5	71	8200617-096	7,62	5	70	8200647-094	25,66	1	70
8200089-038	7,43	1	77	8200398-093	24,41	5	71, 75	8200617-098	5,88	10	71	8200647-095	27,70	1	70
8200091-030	4,53	1	77	8200398-094	24,41	5	71	8200620-029	5,41	10	72	8200647-096	26,32	1	70
8200091-031	4,66	1	77	8200398-096	24,69	5	71	8200620-030	5,41	10	72	8200647-098	20,56	5	71
8200091-033	6,40	1	77	8200398-098	24,06	5	71	8200620-031	5,41	10	72	8200750-030	7,47	5	74
8200091-034	6,49	1	77	8200432-030	11,07	10	75	8200620-038	12,93	1	72	8200750-031	7,47	5	74
8200091-038	4,81	1	77	8200432-038	11,17	10	75	8200620-093	18,60	5	73	8200750-038	8,34	5	74
8200091-093	6,11	1	77	8200432-090	11,07	10	71	8200620-130	7,88	10	72	8200750-093	20,32	5	74
8200092-030	4,62	1	78	8200432-093	12,30	10	71, 75	8200620-198	13,84	10	73	8200760-030	13,09	5	74
8200092-031	4,75	1	78	8200432-094	12,30	10	71	8200620-230	13,62	1	72	8200760-031	13,09	1	74
8200092-033	6,23	1	78	8200432-096	14,28	10	71	8200620-238	15,91	1	72	8200760-038	13,85	1	74
8200092-034	6,31	1	78	8200432-098	11,71	10	71	8200620-293	18,60	5	73	8200760-093	35,60	1	74
8200092-038	4,90	1	78	8200482-030	141,94	1	78	8200620-296	19,35	5	72	8200770-030	16,77	1	74
8200092-093	5,94	1	78	8200482-038	153,25	1	78	8200627-090	5,74	10	70	8200770-031	16,77	1	74
8200097-090	5,03	20	72	82005-30	12,30	5	75	8200627-092	10,43	10	70	8200770-038	20,12	1	74
8200097-094	6,27	5	72	82005-31	13,03	5	75	8200627-093	14,19	5	70	8200770-093	45,69	1	74
8200097-096	7,07	20	72	82005-33	16,28	5	75	8200627-094	14,19	5	70	8200800-090	8,45	10	72
8200097-098	5,44	20	72	82005-34	16,37	5	75	8200627-095	15,32	5	70	8200800-094	10,25	10	72
8200101-030	11,18	10	75	82005-38	13,30	5	75	8200627-096	14,55	5	70	8200800-096	11,86	10	72
8200101-038	11,34	10	75	82005-93	14,26	5	71, 75	8200627-098	11,21	10	71	8200800-098	9,14	10	72
8200101-090	11,18	10	71	8200545-030	13,66	5	78	8200630-029	10,13	5	72	82010-30	4,22	20	76
8200101-093	12,01	10	71, 75	8200545-031	14,89	5	78	8200630-030	10,13	5	72	82010-31	4,34	20	76
8200101-094	12,01	10	71	8200545-033	18,62	5	78	8200630-031	10,13	5	72	82010-33	5,42	20	76
8200101-096	13,41	10	71	8200545-034	17,16	5	78	8200630-038	23,58	1	72	82010-34	5,44	20	76
8200101-098	11,67	10	71	8200545-038	16,19	5	78	8200630-093	26,16	1	73	82010-38	4,63	20	76
8200111-090	4,88	5	72	8200545-090	13,66	5	72	8200630-130	14,29	5	72	82010-93	4,77	20	71, 76
8200111-094	6,41	5	72	8200545-093	16,00	5	72, 78	8200630-198	25,24	5	73	8201090-030	4,55	1	78
8200111-096	6,86	5	72	8200545-094	16,00	5	72	8200630-230	19,18	1	72	8201090-031	4,72	1	78
8200111-098	5,27	5	72	8200545-096	19,12	5	72	8200630-238	22,42	1	72	8201090-033	6,41	1	78
8200201-030	12,52	10	75	8200545-098	17,16	5	72	8200630-293	26,16	1	73	8201090-034	6,41	1	78
8200201-038	12,70	10	75	82006-30	12,40	5	75	8200630-296	27,21	1	72	8201090-038	5,02	1	78
8200201-090	12,52	10	71	82006-31	13,19	5	75	8200637-090	8,05	5	70	8201090-093	6,01	1	78
8200201-093	13,44	10	71, 75	82006-33	16,55	5	75	8200637-092	14,81	5	70	8201092-030	4,81	1	78
8200201-094	13,44	10	71	82006-34	16,63	5	75	8200637-093	20,17	1	70	8201092-031	4,94	1	78
8200201-096	15,00	10	71	82006-38	13,50	5	75	8200637-094	20,17	1	70	8201092-033	6,49	1	78
8200201-098	13,06	10	71	82006-93	14,48	5	71, 75	8200637-095	21,78	1	70	8201092-034	6,49	1	78
8200251-030	22,42	5	75	8200610-029	3,40	10	72	8200637-096	20,69	1	70	8201092-038	5,11	1	78
8200251-038	23,49	5	75	8200610-030	3,40	10	72	8200637-098	15,94	5	71	8201092-093	6,12	1	78
8200251-090	22,42	5	71	8200610-031	3,40	10	72	8200640-029	13,31	1	72	8201094-030	4,37	1	78
8200251-093	23,87	5	71, 75	8200610-038	7,97	5	72	8200640-030	13,31	1	72	8201094-031	4,54	1	78
8200251-094	23,87	5	71	8200610-093	9,62	10	73	8200640-031	13,31	1	72	8201094-033	6,12	1	78
8200251-096	25,61	5	71	8200610-130	4,97	10	72	8200640-038	31,54	1	72	8201094-034	6,12	1	78
8200251-098	23,61	5	71	8200610-198	8,53	10	73	8200640-093	33,32	1	73	8201094-038	4,81	1	78
8200397-030	29,06	5	75	8200610-230	8,11	5	72	8200640-130	19,13	5	72	8201094-090	3,96	1	72
8200397-038	29,18	5	75	8200610-238	9,48	5	72	8200640-198	33,42	5	73	8201094-093	5,74	1	72, 78
8200397-090	29,06	5	71	8200610-293	9,62	10	73	8200640-230	24,39	1	72	8201094-094	5,48	1	72
8200397-093	29,68	5	71, 75	8200610-296	10,02	10	72	8200640-238	28,44	1	72	8201094-096	5,72	1	72
8200397-094	29,68	5	71	8200617-090	2,99	10	70	8200640-293	33,32	1	73	8201094-098	4,40	1	72

ARTÍCULO	PRECIO €	PIEZAS CAJA	PÁGINA	ARTÍCULO	PRECIO €	PIEZAS CAJA	PÁGINA	ARTÍCULO	PRECIO €	PIEZAS CAJA	PÁGINA	ARTÍCULO	PRECIO €	PIEZAS CAJA	PÁGINA
8201095-030	4,55	1	78	82016-33	8,18	5	76	8201630-291* ^N	43,80	5	73	8202126-090	5,64	5	72
8201095-031	4,72	1	78	82016-34	8,20	5	76	8201630-294* ^N	43,80	5	73	8202126-094	7,28	1	72
8201095-033	6,41	1	78	82016-38	6,39	5	76	8201630-344* ^N	46,44	5	73	8202126-096	7,93	5	72
8201095-034	6,41	1	78	82016-93	7,18	10	71, 76	8201630-370* ^N	103,94	5	73	8202126-098	6,10	5	72
8201095-038	5,02	1	78	8201610-093	18,53	5	73	8201630-391* ^N	46,44	5	73	82025-30	9,56	5	76
8201095-093	6,01	1	78	8201610-240	16,84	5	73	8201630-394	46,44	5	73	82025-31	9,92	5	76
8201097-060	48,03	1	78	8201610-241	18,17	5	73	8201630-395* ^N	48,14	5	73	82025-33	14,81	5	76
8201097-061	49,39	1	78	8201610-242	18,85	1	73	8201630-398	46,44	5	73	82025-34	14,87	5	76
8201097-063	50,76	1	78	8201610-243	16,84	5	73	8201630-496* ^N	47,34	5	74	82025-38	12,41	5	76
8201097-064	50,76	1	78	8201610-244	18,17	5	73	8201640-093	56,70	1	73	82025-93	12,50	5	76
8201097-068	48,49	1	78	8201610-245	18,85	1	73	8201640-240	51,49	1	73	82026-30	5,93	20	76
82011-30	5,41	20	76	8201610-248	18,56	1	73	8201640-241	55,61	1	73	82026-31	6,10	20	76
82011-31	5,62	20	76	8201610-270	31,71	1	73	8201640-242	57,67	1	73	82026-33	7,90	20	76
82011-33	7,79	20	76	8201610-271	32,27	1	73	8201640-243	51,49	1	73	82026-34	7,94	20	76
82011-34	7,84	20	76	8201610-291* ^N	18,17	10	73	8201640-244	55,61	1	73	82026-38	6,45	20	76
82011-38	6,15	20	76	8201610-294* ^N	18,17	10	73	8201640-245	57,67	1	73	82026-93	6,93	10	71, 76
82011-93	6,72	5	72, 76	8201610-344* ^N	19,27	10	73	8201640-248	56,83	1	73	82027-30	6,12	5	76
8201111-090	4,88	5	72	8201610-370* ^N	34,21	10	73	8201640-270	128,95	1	73	82027-31	6,30	5	76
8201111-094	6,55	5	72	8201610-391* ^N	19,27	10	73	8201640-271	131,17	1	73	82027-33	8,37	5	76
8201111-096	6,86	5	72	8201610-394	19,27	10	73	8201640-291* ^N	55,61	5	73	82027-34	8,40	5	76
8201111-098	5,27	5	72	8201610-395* ^N	19,98	10	73	8201640-294* ^N	55,61	5	73	82027-38	6,55	5	76
8201296-030	5,15	1	78	8201610-398	19,27	10	73	8201640-344* ^N	58,94	5	73	82027-93	7,31	5	76
8201296-031	5,30	1	78	8201610-496* ^N	19,65	10	74	8201640-370* ^N	139,06	5	73	82028-30	6,44	20	76
8201296-033	6,94	1	78	8201620-093	31,71	5	73	8201640-391* ^N	58,94	5	73	82028-31	6,69	20	76
8201296-034	6,94	1	78	8201620-240	28,80	1	73	8201640-394 ^N	58,94	5	73	82028-33	9,18	20	76
8201296-038	5,45	1	78	8201620-241	31,07	1	73	8201640-395* ^N	61,12	5	73	82028-34	9,22	20	76
8201296-090	5,08	1	72	8201620-242	32,24	1	73	8201640-398	58,94	5	73	82028-38	7,18	20	76
8201296-093	5,24	1	72, 76	8201620-243	28,80	1	73	8201640-496* ^N	60,10	5	74	82028-93	8,04	20	71, 76
8201296-094	6,15	1	72	8201620-244	31,07	1	73	82017-30	5,02	10	76	82029-30	6,75	5	76
8201296-096	6,85	1	72	8201620-245	32,24	1	73	82017-31	5,16	10	76	82029-31	6,95	5	76
8201296-098	5,94	1	72	8201620-248	31,75	1	73	82017-33	6,52	10	76	82029-33	9,23	5	76
82013-30	5,05	5	76	8201620-270	51,52	1	73	82017-34	6,56	10	76	82029-34	9,27	5	76
82013-31	5,19	5	76	8201620-271	52,43	1	73	82017-38	5,52	10	76	82029-38	7,14	5	76
82013-33	6,99	5	76	8201620-291* ^N	31,07	10	73	82017-93	5,73	10	71, 76	82029-93	8,49	5	71, 76
82013-34	7,03	5	76	8201620-294* ^N	31,07	10	73	82018-30	5,07	5	76	82031-30	5,39	5	76
82013-38	5,50	5	76	8201620-344* ^N	32,94	10	73	82018-31	5,26	5	76	82031-31	5,55	5	76
82013-93	6,14	5	76	8201620-370* ^N	55,58	10	73	82018-33	6,64	5	76	82031-33	7,43	5	76
8201432-030* ^N	50,28	10	71	8201620-391* ^N	32,94	10	73	82018-34	6,69	5	76	82031-34	7,48	5	76
8201432-038* ^N	50,86	10	71	8201620-394 ^N	32,94	10	73	82018-38	5,62	5	76	82031-38	5,88	5	76
8201432-090* ^N	50,28	10	71	8201620-395* ^N	34,17	10	73	82018-93	5,84	5	76	82031-93	6,48	5	76
8201432-093* ^N	51,87	10	71	8201620-398 ^N	32,94	10	73	8202025-030	9,33	5	78	82033-30	6,82	10	76
8201432-094* ^N	51,87	10	71	8201620-496* ^N	33,62	10	74	8202025-031	9,68	5	78	82033-31	7,08	10	76
8201432-096* ^N	52,29	10	71	8201630-093	44,66	1	73	8202025-033	8,20	5	78	82033-33	9,35	10	76
8201432-098* ^N	50,42	10	71	8201630-240	40,55	1	73	8202025-034	8,25	5	78	82033-34	9,38	10	76
82015-30	5,68	5	76	8201630-241	43,80	1	73	8202025-038	12,17	5	78	82033-38	7,57	10	76
82015-31	5,85	5	76	8201630-242	45,42	1	73	8202025-093	13,75	5	78	82033-93	8,18	10	71, 76
82015-33	8,03	5	76	8201630-243	40,55	1	73	8202026-030	6,00	5	78	82034-30	7,53	5	76
82015-34	8,05	5	76	8201630-244	43,80	1	73	8202026-031	6,17	5	78	82034-31	7,75	5	76
82015-38	6,28	5	76	8201630-245	45,42	1	73	8202026-033	7,97	5	78	82034-33	10,69	5	76
82015-93	7,18	5	76	8201630-248	44,74	1	73	8202026-034	8,03	5	78	82034-38	7,98	5	76
82016-30	5,74	10	76	8201630-270	96,38	1	73	8202026-038	6,53	5	78	82034-93	9,80	5	76
82016-31	5,96	10	76	8201630-271	98,04	1	73	8202026-093	7,35	5	72, 78	82035-30	19,01	5	76

RELACIÓN NUMÉRICA DE ARTÍCULOS

ÍNDICE GENERAL - RELACIÓN NUMÉRICA POR ARTÍCULO

ARTÍCULO	PRECIO €	PIEZAS CAJA	PÁGINA	ARTÍCULO	PRECIO €	PIEZAS CAJA	PÁGINA	ARTÍCULO	PRECIO €	PIEZAS CAJA	PÁGINA	ARTÍCULO	PRECIO €	PIEZAS CAJA	PÁGINA
82035-31	19,55	5	76	82060-30	4,81	5	77	82090-93	16,91	10	77	82714-34	17,68	10	75
82035-38	22,64	5	76	82060-31	4,95	5	77	82096-30	53,99	1	77	82720-31	6,53	10	75
82036-30	11,61	5	76	82060-33	7,41	5	77	82096-31	56,04	1	77	82724-34	30,06	10	75
82036-31	12,05	5	76	82060-34	7,44	5	77	82096-33	57,80	1	77	82730-31	11,90	10	75
82036-33	14,00	5	76	82060-38	5,22	5	77	82096-34	58,08	1	77	82734-34	44,80	5	75
82036-34	14,09	5	76	82060-93	6,46	5	77	82096-38	57,39	1	77	82740-31	15,94	10	75
82036-38	12,33	5	76	82062-93	7,15	20	72	82096-93	50,60	1	77	82744-34	58,24	5	75
82036-93	12,26	5	76	82065-30	4,67	5	77	82097-30	5,52	20	77	82750-30	8,10	10	75
82040-30	5,46	10	76	82065-31	4,81	5	77	82097-31	5,68	20	77	82750-31	8,33	10	75
82040-31	5,62	10	76	82065-32	4,67	5	77	82097-33	7,14	20	77	82750-38	8,77	10	75
82040-33	7,79	10	76	82068-090*	5,68	10	72	82097-34	7,17	20	77	82751-30	8,37	10	75
82040-34	7,85	10	76	82068-094*	7,19	10	72	82097-38	5,91	20	77	82751-31	8,61	10	75
82040-38	5,95	10	76	82068-096*	8,02	10	72	82097-93	6,27	20	72, 77	82751-38	9,00	10	75
82040-64	7,41	10	76	82068-098*	5,94	10	72	8221096-030	4,61	1	78	82760-30	13,84	5	75
82040-93	6,81	10	76	82068-30	5,83	10	77	8221096-031	4,75	1	78	82760-31	14,24	5	75
82041-30	4,84	10	76	82068-31	6,00	10	77	8221096-033	6,22	1	78	82760-38	14,97	5	75
82041-31	4,98	10	76	82068-33	8,23	10	77	8221096-034	6,22	1	78	82761-30	14,63	5	75
82041-33	7,31	10	76	82068-34	8,25	10	77	8221096-038	4,88	1	78	82761-31	15,05	5	75
82041-34	7,34	10	76	82068-38	6,10	10	77	8221096-090	4,48	1	72	82761-38	15,81	5	75
82041-37	5,61	10	76	82068-64	8,03	10	77	8221096-093	5,63	1	72, 78	82771-30	18,76	5	75
82041-38	5,50	10	76	82068-93	7,19	5	72, 77	8221096-094	5,63	1	72	82771-31	19,30	5	75
82041-64	7,27	10	76	82078-60	11,57	5	77	8221096-096	6,01	1	72	82771-38	21,76	5	75
82041-93	6,53	10	71, 76	82078-61	11,90	5	77	8221096-098	5,22	1	72	82800-30	9,24	10	77
82045-30	4,82	10	76	82078-63	13,59	5	77	82505-30	5,89	5	77	82800-31	9,51	10	77
82045-31	5,01	10	76	82078-64	13,59	5	77	82505-31	6,06	5	77	82800-33	11,81	10	77
82045-33	7,05	10	76	82078-68	11,73	5	77	82505-33	11,77	5	77	82800-34	11,87	10	77
82045-34	7,05	10	76	82078-93	11,89	5	72, 77	82505-34	11,82	5	77	82800-38	9,74	10	77
82045-38	5,30	10	76	82079-30	9,09	5	77	82505-38	10,43	5	77	82800-93	10,25	10	72, 77
82045-93	6,23	5	76	82079-31	9,36	5	77	82505-93	10,48	5	77	82812-32	4,71	10	75
82051-30	5,76	10	76	82079-38	9,74	5	77	82578-30	14,21	5	77	82814-33	17,54	10	75
82051-31	5,98	10	76	82079-93	9,88	5	77	82578-31	14,62	5	77	82814-34	17,90	10	75
82051-33	8,11	10	76	82080-30	5,36	5	77	82578-38	15,26	5	77	82814-36	21,64	10	75
82051-34	8,17	10	76	82080-31	5,52	5	77	82579-30	15,59	5	77	82817-31	38,68	1	74
82051-38	6,41	10	76	82080-33	8,14	5	77	82579-31	16,04	5	77	82817-32	40,71	1	74
82051-93	7,09	10	71, 76	82080-34	8,16	5	77	82579-38	16,76	5	77	82817-34	40,71	1	74
82052-30	6,16	5	76	82080-38	5,83	5	77	82610-30	3,81	10	75	82817-35	40,71	1	74
82052-31	6,39	5	76	82080-93	7,12	5	77	82611-33	5,90	10	75	82817-37	33,21	1	74
82052-33	9,07	5	76	82082-30	5,91	5	77	82617-30	39,97	1	74	82817-38	33,21	1	74
82052-38	6,87	5	76	82082-31	6,08	5	77	82617-60	29,56	1	74	82822-32	7,66	10	75
82052-93	7,96	5	71, 76	82082-33	8,82	5	77	82620-30	6,19	10	75	82824-33	30,28	10	75
82053-30	5,20	20	76	82082-34	8,87	5	77	82621-33	9,22	10	75	82824-34	30,86	10	75
82053-31	5,52	20	76	82082-38	6,32	5	77	82627-30	59,05	1	74	82824-36	37,76	10	75
82053-33	6,95	20	76	82088-30	6,14	10	77	82627-60	41,83	1	74	82827-31	54,75	1	74
82053-34	7,01	20	76	82088-31	6,37	10	77	82630-30	11,57	10	75	82827-32	59,73	1	74
82053-38	5,60	20	76	82088-33	7,91	10	77	82631-33	17,52	5	75	82827-34	59,73	1	74
82053-93	6,11	20	71, 76	82088-34	7,96	10	77	82637-30	91,49	1	74	82827-35	59,73	1	74
82054-30	8,60	5	76	82088-38	6,86	10	77	82637-60	68,40	1	74	82827-37	46,99	1	74
82054-31	8,84	5	76	82088-93	6,67	10	77	82640-30	15,49	10	75	82827-38	46,99	1	74
82054-33	11,82	5	76	82090-30	14,65	10	77	82641-33	22,90	5	75	82832-32	13,96	5	75
82054-34	11,86	5	76	82090-31	15,07	10	77	82647-30	118,87	1	74	82834-33	45,83	5	75
82054-38	9,24	5	76	82090-33	18,57	10	77	82647-60	88,87	1	74	82834-34	46,10	5	75
82054-93	10,33	5	71, 76	82090-38	15,82	10	77	82710-31	4,02	10	75	82834-36	52,55	5	75

ARTÍCULO	PRECIO €	PIEZAS CAJA	PÁGINA	ARTÍCULO	PRECIO €	PIEZAS CAJA	PÁGINA	ARTÍCULO	PRECIO €	PIEZAS CAJA	PÁGINA	ARTÍCULO	PRECIO €	PIEZAS CAJA	PÁGINA
82837-31	86,97	1	74	82960-39	7,79	1	77	860420**-109	65,00	1	136	88018-32	7,37	20	78
82837-32	93,08	1	74	8400100-039	84,94	1	84	860430**-109	96,00	1	136	88018-38	7,37	20	78
82837-34	93,08	1	74	8400651-030	259,89	1	84	86044230-393 ^N	385,00	1	136	88026-30	8,27	20	79
82837-35	93,08	1	74	8400651-038	259,89	1	84	86044230-394 ^N	385,00	1	136	88026-32	8,97	20	79
82837-37	75,37	1	74	8400651-093	259,89	1	84	86044238-393 ^N	385,00	1	136	88026-38	8,97	20	79
82837-38	75,37	1	74	8400671-030	263,68	1	84	86044238-394 ^N	385,00	1	136	88027-30	8,51	20	79
82842-32	18,71	5	75	8400671-038	263,68	1	84	860443**-309	58,00	1	136	88027-32	9,16	20	79
82844-33	59,04	5	75	8400671-093	263,68	1	84	860459**-039	22,00	1	137	88027-38	9,16	20	79
82844-34	59,34	5	75	86001300-383	163,46	1	137	860462**-393 ^N	149,00	1	136	88028-30	8,68	20	79
82844-36	67,16	5	75	86001300-384	163,46	1	137	860462**-394 ^N	140,00	1	136	88028-32	9,26	20	79
82847-31	113,05	1	74	86001300-393 ^N	164,00	1	137	860466**-393 ^N	290,00	1	136	88028-38	9,26	20	79
82847-32	117,95	1	74	86001300-394 ^N	164,00	1	137	860466**-394 ^N	290,00	1	136	88029-30	9,20	20	79
82847-34	117,95	1	74	86001300-399 ^N	240,00	1	137	860478**-039 ^N	95,00	1	136	88029-32	9,82	20	79
82847-35	117,95	1	74	86001300-583	259,61	1	137	860479**-039 ^N	95,00	1	136	88029-38	9,82	20	79
82847-37	97,94	1	74	86001300-584	259,61	1	137	860487**-039	14,50	1	137	88031-30	7,44	20	79
82847-38	97,94	1	74	86001300-593 ^N	260,00	1	137	860489**-039	22,00	1	137	88031-32	8,02	20	79
82914-33	20,62	10	75	86001300-594 ^N	260,00	1	137	860969**-039	35,00	1	137	88031-38	8,02	20	79
82914-34	21,02	10	75	86001300-599 ^N	350,00	1	137	86097900-039	16,00	1	137	88032-30	7,17	20	79
82917-33	33,21	1	74	86002300-383	182,69	1	137	86097905-039	32,00	1	137	88032-32	7,65	20	79
82917-34	38,68	1	74	86002300-384	182,69	1	137	860987**-039	9,60	1	137	88032-38	7,65	20	79
82917-38	38,68	1	74	86002300-393 ^N	183,00	1	137	86098700-039	9,60	1	137	88033-30	8,89	10	79
82917-62	40,71	1	74	86002300-394 ^N	183,00	1	137	860988**-039	11,50	1	137	88033-32	12,27	5	79
82917-63	37,92	1	74	86002300-399 ^N	275,00	1	137	86098900-039	14,50	1	137	88033-38	12,27	5	79
82917-65	39,55	1	74	86002300-583	276,92	1	137	860999**-039	41,00	1	137	88034-30	11,44	10	79
82917-66	39,55	1	74	86002300-584	276,92	1	137	86099900-510	29,00	1	137	88034-32	15,56	10	79
82924-33	35,95	10	75	86002300-593 ^N	277,00	1	137	86099900-520	12,60	1	137	88034-38	15,56	10	79
82924-34	36,58	10	75	86002300-594 ^N	277,00	1	137	86099900-612	87,00	1	137	88040-60	8,09	10	79
82927-33	46,99	1	74	86002300-599 ^N	380,00	1	137	86099900-616	116,00	1	137	88040-62	8,51	10	79
82927-34	54,75	1	74	86003300-383	240,38	1	137	86099900-624	174,00	1	137	88040-68	8,51	10	79
82927-38	54,75	1	74	86003300-384	240,38	1	137	86099900-700	51,00	1	137	88041-60	8,09	10	79
82927-62	59,73	1	74	86003300-393 ^N	241,00	1	137	86099900-712	39,00	1	137	88041-62	8,51	10	79
82927-63	55,99	1	74	86003300-394 ^N	241,00	1	137	86099900-716	52,00	1	137	88041-67	9,27	10	79
82927-65	58,45	1	74	86003300-399 ^N	370,00	1	137	86099900-724	78,00	1	137	88041-68	8,51	10	79
82927-66	58,45	1	74	86003300-583	337,50	1	137	88010-30	6,48	20	78	88052-30	7,07	10	79
82934-33	50,60	5	75	86003300-584	337,50	1	137	88010-32	6,95	20	78	88052-32	7,61	10	79
82934-34	50,88	5	75	86003300-593 ^N	338,00	1	137	88010-38	6,95	20	78	88052-38	7,61	10	79
82937-33	71,49	1	74	86003300-594 ^N	338,00	1	137	88011-30	6,69	20	78	88053-30	7,12	10	79
82937-34	86,97	1	74	86003300-599 ^N	470,00	1	137	88011-32	7,17	20	78	88053-32	7,64	10	79
82937-38	86,97	1	74	86004300-183	125,00	1	137	88011-38	7,17	20	78	88053-38	7,64	10	79
82937-62	93,08	1	74	86004300-184	125,00	1	137	88012-30	7,17	20	78	88054-30	11,96	10	79
82937-63	86,26	1	74	86004300-193 ^N	125,00	1	137	88012-32	7,36	20	78	88054-32	12,85	10	79
82937-65	88,38	1	74	86004300-194 ^N	125,00	1	137	88012-38	7,36	20	78	88054-38	12,85	10	79
82937-66	88,38	1	74	860044**-209	97,00	1	136	88015-30	6,88	20	78	88062-30	7,30	10	79
82944-33	64,31	5	75	860210**-109	50,00	1	136	88015-32	7,44	20	78	88062-32	7,81	10	79
82944-34	64,61	5	75	860220**-109	65,00	1	136	88015-38	7,44	20	78	88062-38	7,81	10	79
82947-33	92,90	1	74	860230**-109	96,00	1	136	88016-30	6,88	20	78	88063-30	7,62	20	79
82947-34	113,05	1	74	860243**-309	58,00	1	136	88016-32	7,44	20	78	88063-32	8,30	20	79
82947-38	113,05	1	74	860244**-209	97,00	1	136	88016-38	7,44	20	78	88063-38	8,30	20	79
82947-62	117,95	1	74	860245**-209 ^N	95,00	1	136	88017-30	6,75	20	78	88065-30	5,94	10	79
82947-63	112,13	1	74	860246**-209 ^N	95,00	1	136	88017-32	7,22	20	78	88065-31	5,94	10	79
82947-65	117,07	1	74	860259**-039	22,00	1	137	88017-38	7,22	20	78	88065-32	5,98	10	79
82947-66	117,07	1	74	860410**-109	50,00	1	136	88018-30	6,85	20	78	88068-60	6,88	10	79

RELACIÓN NUMÉRICA DE ARTÍCULOS

ÍNDICE GENERAL - RELACIÓN NUMÉRICA POR ARTÍCULO

ARTÍCULO	PRECIO €	PIEZAS CAJA	PÁGINA	ARTÍCULO	PRECIO €	PIEZAS CAJA	PÁGINA	ARTÍCULO	PRECIO €	PIEZAS CAJA	PÁGINA	ARTÍCULO	PRECIO €	PIEZAS CAJA	PÁGINA
88068-62	7,36	10	79	89000202-039	158,57	1	84	89920133-039	37,00	1	150	89941830-039	18,50	1	150
88068-68	7,36	10	79	89000203-039	169,12	1	84	89920138-039	37,00	1	150	89941838-039	18,50	1	150
88078-30	15,86	10	79	89000204-039	158,57	1	84	89920230-039	70,50	1	150	89961930-039	34,00	1	151
88078-32	17,10	10	79	89000300-039	628,96	1	84	89920233-039	70,50	1	150	89961938-039	34,00	1	151
88078-38	17,10	10	79	89000301-039	126,85	1	84	89920238-039	70,50	1	150	89962930-039	64,00	1	151
88080-30	3,74	10	79	89000302-039	142,70	1	84	89920330-039	102,50	1	150	89962938-039	64,00	1	151
88080-32	3,94	10	79	89000303-039	158,57	1	84	89920333-039	102,50	1	150	89963930-039	93,00	1	151
88080-38	3,94	10	79	89000304-039	158,57	1	84	89920338-039	102,50	1	150	89963938-039	93,00	1	151
88081-30	17,85	10	79	89000305-039	158,57	1	84	89921130-039	62,00	1	150	89964930-039	56,00	1	151
88081-38	18,70	10	79	89000310-039	158,57	1	84	89921138-039	62,00	1	150	89964938-039	56,00	1	151
88082-30	7,62	10	79	89000311-039	158,57	1	84	89921230-039	105,00	1	150	89965930-039	95,00	1	151
88082-32	8,30	10	79	89000401-039	184,99	1	84	89921238-039	105,00	1	150	89965938-039	95,00	1	151
88082-38	8,30	10	79	89000500-039	628,96	1	84	89921330-039	148,00	1	150	89966930-039	134,00	1	151
88086-30	18,84	10	79	89000990-039	11,63	1	84	89921338-039	148,00	1	150	89966938-039	134,00	1	151
88086-38	19,68	10	79	8900150-039	82,46	1	84	89930130-039	55,50	1	150	89966930-100	14,50	1	151
88088-30	7,55	10	79	89910130-039	16,50	1	150	89930138-039	55,50	1	150	89966930-101	14,50	1	151
88088-32	7,66	10	79	89910138-039	16,50	1	150	89930230-039	99,00	1	150	89966930-102	10,00	1	151
88088-38	7,66	10	79	89910230-039	16,50	1	150	89930238-039	99,00	1	150	89966930-103	12,80	1	151
88097-30	7,30	10	79	89910238-039	16,50	1	150	89930330-039	142,00	1	150	89966930-104	59,00	1	151
88097-32	7,79	10	79	89910330-039	37,00	1	150	89930338-039	142,00	1	150	89966930-105	38,00	1	151
88097-38	7,79	10	79	89910338-039	37,00	1	150	89931130-039	81,00	1	150	89966930-106	38,00	1	151
88545-30	17,84	5	79	89910430-039	11,20	1	150	89931138-039	81,00	1	150	89966930-107	51,00	1	151
88545-38	18,69	5	79	89910438-039	11,20	1	150	89931230-039	136,00	1	150	89966930-108	51,00	1	151
88610-30	4,56	10	79	89910530-039	80,50	1	150	89931238-039	136,00	1	150	89966930-109	51,00	1	151
88610-33	28,20	1	79	89910538-039	80,50	1	150	89931330-039	173,00	1	150	89966930-110	51,00	1	151
88610-35	28,66	1	79	89910630-039	49,50	1	150	89931338-039	173,00	1	150	89966930-111	66,00	1	151
88610-36	31,96	1	79	89910638-039	49,50	1	150	89940130-039	35,00	1	150	89966930-112	2,20	1	151
88610-38	4,87	10	79	89910730-039	49,50	1	150	89940138-039	35,00	1	150	89966930-113	5,60	1	151
88620-30	6,93	10	79	89910738-039	49,50	1	150	89940230-039	35,00	1	150	89966930-114	5,60	1	151
88620-33	45,36	1	79	89910830-039	55,50	1	150	89940238-039	35,00	1	150	89966930-115	19,00	1	151
88620-35	47,11	1	79	89910838-039	55,50	1	150	89940330-039	60,50	1	150	89966938-100	14,50	1	151
88620-36	54,74	1	79	89910930-039	55,50	1	150	89940338-039	60,50	1	150	89966938-101	14,50	1	151
88620-38	7,30	10	79	89910938-039	55,50	1	150	89940430-039	25,00	1	150	89966938-102	10,00	1	151
88630-30	12,53	10	79	89911030-039	55,50	1	150	89940438-039	25,00	1	150	89966938-103	12,80	1	151
88630-33	61,34	1	79	89911038-039	55,50	1	150	89940530-039	119,50	1	150	89966938-104	59,00	1	151
88630-35	63,05	1	79	89911130-039	55,50	1	150	89940538-039	119,50	1	150	89966938-105	38,00	1	151
88630-36	72,55	1	79	89911138-039	55,50	1	150	89940630-039	68,00	1	150	89966938-106	38,00	1	151
88630-38	13,20	10	79	89911230-039	73,00	1	150	89940638-039	68,00	1	150	89966938-107	51,00	1	151
88640-30	19,98	1	79	89911238-039	73,00	1	150	89940730-039	68,00	1	150	89966938-108	51,00	1	151
88800-30	11,68	10	79	89911330-039	21,00	1	150	89940738-039	68,00	1	150	89966938-109	51,00	1	151
88800-32	12,56	10	79	89911338-039	21,00	1	150	89940830-039	92,50	1	150	89966938-110	51,00	1	151
88800-38	12,56	10	79	89911430-039	4,10	1	150	89940838-039	92,50	1	150	89966938-111	66,00	1	151
89000110-030	1257,93	1	84	89911438-039	4,10	1	150	89940930-039	92,50	1	150	89966938-112	2,20	1	151
89000110-038	1257,93	1	84	89911530-039	35,00	1	150	89940938-039	92,50	1	150	89966938-113	5,60	1	151
89000150-030	189,21	1	84	89911538-039	35,00	1	150	89941030-039	92,50	1	150	89966938-114	5,60	1	151
89000150-038	189,21	1	84	89911630-039	32,50	1	150	89941038-039	92,50	1	150	89966938-115	19,00	1	151
89000151-030	189,21	1	84	89911638-039	32,50	1	150	89941130-039	92,50	1	150	8999901-039	64,78	1	85
89000151-038	189,21	1	84	89911730-039	15,00	1	150	89941138-039	92,50	1	150	91239954-300	195,00	1	152
89000152-030	189,21	1	84	89911738-039	15,00	1	150	89941230-039	117,50	1	150	91410911-2**	108,00	1	142
89000152-038	189,21	1	84	89911830-039	17,50	1	150	89941238-039	117,50	1	150	91410911-3**	108,00	1	142
89000200-039	158,57	1	84	89911838-039	17,50	1	150	89941730-039	16,00	1	150	91410911-4**	108,00	1	142
89000201-039	158,57	1	84	89920130-039	37,00	1	150	89941738-039	16,00	1	150	91410912-2**	108,00	1	142

ARTÍCULO	PRECIO €	PIEZAS CAJA	PÁGINA	ARTÍCULO	PRECIO €	PIEZAS CAJA	PÁGINA	ARTÍCULO	PRECIO €	PIEZAS CAJA	PÁGINA	ARTÍCULO	PRECIO €	PIEZAS CAJA	PÁGINA
91410912-3**	108,00	1	142	91620104-299	44,00	1	151	91891611-4**	248,00	1	134	91899192-0**	121,00	1	135
91410912-4**	108,00	1	142	91620104-399	44,00	1	151	91891612-2**	248,00	1	134	91899193-0**	175,00	1	135
91411931-2**	144,00	1	142	91620104-499	44,00	1	151	91891612-3**	248,00	1	134	91899201-0**	102,00	1	135
91411931-3**	144,00	1	142	91621104-299	73,00	1	151	91891612-4**	248,00	1	134	91899202-0**	153,00	1	135
91411931-4**	144,00	1	142	91621104-399	73,00	1	151	91892007-0**	57,00	1	135	91899203-0**	153,00	1	135
91411932-2**	144,00	1	142	91621104-499	73,00	1	151	91892311-2**	389,00	1	134	91899204-0**	141,00	1	134
91411932-3**	144,00	1	142	91621104-899	91,00	1	151	91892311-3**	389,00	1	134	91899205-0**	153,00	1	134
91411932-4**	144,00	1	142	91713010-2**	693,00	1	134, 152	91892311-4**	389,00	1	134	91899206-0**	166,00	1	134
91420911-2**	99,00	1	142	91713010-3**	693,00	1	134, 152	91892312-2**	389,00	1	134	91899222-0**	146,00	1	135
91420911-3**	99,00	1	142	91713010-4**	693,00	1	134, 152	91892312-3**	389,00	1	134	91899292-0**	134,00	1	135
91420911-4**	99,00	1	142	91713110-2**	747,00	1	134, 152	91892312-4**	389,00	1	134	91899293-0**	190,00	1	135
91420912-2**	99,00	1	142	91713110-3**	747,00	1	134, 152	91892611-2**	305,00	1	134	91899301-0**	154,00	1	135
91420912-3**	99,00	1	142	91713110-4**	747,00	1	152	91892611-3**	305,00	1	134	91899302-0**	197,00	1	135
91420912-4**	99,00	1	142	91770305-2**	343,00	1	134	91892611-4**	305,00	1	134	91899307-0**	121,00	1	135
91420983-2**	201,00	1	142	91770305-3**	343,00	1	134	91892612-2**	305,00	1	134	91899391-0**	154,00	1	135
91420983-3**	201,00	1	142	91770305-4**	343,00	1	134	91892612-3**	305,00	1	134	91899392-0**	188,00	1	135
91420983-4**	201,00	1	142	91770605-2**	288,00	1	134	91892612-4**	305,00	1	134	91899401-0**	168,00	1	135
91421931-200	133,00	1	143	91770605-3**	288,00	1	134	91893009-0**	103,00	1	135	91899402-0**	212,00	1	135
91421931-300	133,00	1	143	91770605-4**	288,00	1	134	91893010-0**	87,00	1	135	91899407-0**	134,00	1	135
91421931-400	133,00	1	143	91771305-2**	389,00	1	134	91893011-0**	47,00	1	135	91899491-0**	168,00	1	135
91421932-2**	133,00	1	143	91771305-3**	389,00	1	134	91893012-0**	113,00	1	135	91899492-0**	201,00	1	135
91421932-3**	133,00	1	143	91771305-4**	389,00	1	134	91893112-0**	167,00	1	135	92011661-2**	233,00	1	147
91491099-999	29,00	1	142, 143	91771605-2**	322,00	1	134	91893212-0**	182,00	1	135	92011661-3**	233,00	1	147
91491199-999	43,00	1	142, 143	91771605-3**	322,00	1	134	91894115-0**	246,00	1	136	92011661-4**	233,00	1	147
91491299-999	55,00	1	142, 143	91771605-4**	322,00	1	134	91894215-0**	255,00	1	136	92011662-2**	233,00	1	147
91493099-999	28,00	1	142	91772305-2**	441,00	1	134	91894980-0**	137,00	1	135	92011662-3**	233,00	1	147
91493199-999	46,00	1	142	91772305-3**	441,00	1	134	91894982-0**	154,00	1	135	92011662-4**	233,00	1	147
91493299-999	54,00	1	142	91772305-4**	441,00	1	134	91894990-0**	148,00	1	135	92011663-2**	233,00	1	147
91493399-999	26,00	1	142	91772605-2**	363,00	1	134	91894992-0**	170,00	1	135	92011663-3**	233,00	1	147
91493499-999	56,00	1	142	91772605-3**	363,00	1	134	91895108-999	58,00	1	135	92011663-4**	233,00	1	147
91493599-999	75,00	1	142	91772605-4**	363,00	1	134	91895208-999	71,00	1	135	92021661-2**	259,00	1	148
91551002-2**	172,00	1	141	91791901-9**	237,00	1	136	91899000-999	11,80	1	135	92021661-3**	259,00	1	148
91551002-3**	172,00	1	141	91791902-9**	292,00	1	136	91899001-0**	83,00	1	135	92021661-4**	259,00	1	148
91551002-4**	172,00	1	141	91791903-9**	349,00	1	136	91899002-0**	124,00	1	135	92021662-2**	259,00	1	148
91551003-2**	172,00	1	141	91793901-999	114,00	1	136, 147, 148, 151	91899003-0**	124,00	1	135	92021662-3**	259,00	1	148
91551003-3**	172,00	1	141	91793902-999	120,00	1	136, 147, 148, 151	91899004-0**	90,00	1	134	92021662-4**	259,00	1	148
91551003-4**	172,00	1	141	91793903-999	133,00	1	136, 147, 148, 151	91899005-0**	102,00	1	134	92021663-2**	259,00	1	148
91552002-2**	199,00	1	141	91813010-2**	750,00	1	134, 152	91899006-0**	115,00	1	134	92021663-3**	259,00	1	148
91552002-3**	199,00	1	141	91813010-3**	750,00	1	134, 152	91899007-0**	64,00	1	135	92021663-4**	259,00	1	148
91552002-4**	199,00	1	141	91813010-4**	750,00	1	134, 152	91899018-0**	77,00	1	136	92061011-2**	219,00	1	147
91552003-2**	199,00	1	141	91813110-2**	820,00	1	134, 152	91899022-0**	117,00	1	135	92061011-3**	219,00	1	147
91552003-3**	199,00	1	141	91813110-3**	820,00	1	134, 152	91899091-0**	99,00	1	135	92061011-4**	219,00	1	147
91552003-4**	199,00	1	141	91813110-4**	820,00	1	134, 152	91899092-0**	115,00	1	135	92061012-2**	219,00	1	147
91563002-2**	139,00	1	142	91891311-2**	367,00	1	134	91899093-0**	161,00	1	135	92061012-3**	219,00	1	147
91563002-3**	139,00	1	142	91891311-3**	367,00	1	134	91899099-9**	32,00	1	135	92061012-4**	219,00	1	147
91563002-4**	139,00	1	142	91891311-4**	367,00	1	134	91899101-0**	92,00	1	135	92061013-2**	219,00	1	147
91563003-2**	139,00	1	142	91891312-2**	367,00	1	134	91899102-0**	139,00	1	135	92061013-3**	219,00	1	147
91563003-3**	139,00	1	142	91891312-3**	367,00	1	134	91899103-0**	139,00	1	135	92061013-4**	219,00	1	147
91563003-4**	139,00	1	142	91891312-4**	367,00	1	134	91899104-0**	128,00	1	134	92061311-2**	278,00	1	147
91591019-999	67,00	1	142	91891611-2**	248,00	1	134	91899105-0**	141,00	1	134	92061311-3**	278,00	1	147
91592019-000	6,60	1	142	91891611-3**	248,00	1	134	91899106-0**	153,00	1	134	92061311-4**	278,00	1	147
91592019-999	80,00	1	142	91891611-3**	248,00	1	134	91899122-0**	132,00	1	135	92061312-2**	278,00	1	147

RELACIÓN NUMÉRICA DE ARTÍCULOS

ÍNDICE GENERAL - RELACIÓN NUMÉRICA POR ARTÍCULO

ARTÍCULO	PRECIO €	PIEZAS CAJA	PÁGINA	ARTÍCULO	PRECIO €	PIEZAS CAJA	PÁGINA	ARTÍCULO	PRECIO €	PIEZAS CAJA	PÁGINA	ARTÍCULO	PRECIO €	PIEZAS CAJA	PÁGINA
92061312-3**	278,00	1	147	ALK224/8	106,37	1	108	BM712603	24,25	8	87	CL62U	12,47	5	104, 125
92061312-4**	278,00	1	147	ALK225/8	120,54	1	108	BM713201	6,11	8	87	CL63F	15,91	5	125
92061313-2**	278,00	1	147	ALK227/8	127,60	1	108	BM713301	8,02	8	87	CL63U	14,92	5	125
92061313-3**	278,00	1	147	ALK22P05/8	81,54	1	109	BM713402	9,49	8	87	CL65F	20,50	5	125
92061313-4**	278,00	1	147	ALK22P10/8	122,05	1	109	BM713601	13,81	8	87	CL65U	19,70	5	125
92062011-2**	239,00	1	148	ALK22P15/8	143,70	1	109	BM714401	10,96	8	87	CL6A0F	11,68	5	125
92062011-3**	239,00	1	148	ALK5400/8	566,02	1	109	BM714501	12,38	8	87	CL6A1F	13,35	5	125
92062011-4**	239,00	1	148	ALK544/8	134,16	1	108	BM714601	15,07	8	87	CL6A2F	15,91	5	125
92062012-2**	239,00	1	148	ALK545/8	146,79	1	108	BM716301	28,25	4	87	CL6A3F	18,41	5	125
92062012-3**	239,00	1	148	ALK546/8	158,89	1	108	BM716501	31,51	4	87	CL6A5F	23,71	5	125
92062012-4**	239,00	1	148	ALK54P05/8	142,29	1	109	BM722401	14,10	8	87	CL911101	2,75	2	87
92062013-2**	239,00	1	148	ALK54P10/8	232,84	1	109	BM722601	17,18	8	87	CL912101	4,12	12	87
92062013-3**	239,00	1	148	ALK54P15/8	323,72	1	109	CB530F	A consultar	305 m	125	CL912101	2,15	2	87
92062013-4**	239,00	1	148	ALK7200/8	497,84	1	108	CB530U	A consultar	305 m	125	CL912201	3,37	14	87
92062311-2**	292,00	1	148	ALK724/8	132,21	1	108	CB531U	A consultar	305m	125	CL912202	4,00	14	87
92062311-3**	292,00	1	148	ALK725/8	143,45	1	108	CB630U	A consultar	305 m	125	CP524F	331,44	1	125
92062311-4**	292,00	1	148	ALK726/8	154,74	1	108	CB650FD	A consultar	500 m	125	CP524U	194,17	1	125
92062312-2**	292,00	1	148	ALK72P05/8	175,32	1	109	CB6A50FD	A consultar	500 m	125	CP624F	399,15	1	125
92062312-3**	292,00	1	148	ALK72P10/8	224,21	1	109	CH100	67,22	1	125	CP624U	261,52	1	125
92062312-4**	292,00	1	148	ALK72P15/8	289,77	1	109	CH101	33,50	1	125	CR0001/14	2,84	10	126
92062313-2**	292,00	1	148	ALKA02/8	13,15	1	108, 124	CH104	104,44	1	126	CR0001/2	2,89	10	126
92062313-3**	292,00	1	148	BM140100	12,32	6	87	CH106	45,32	1	126	CR0001/6	2,89	10	126
92062313-4**	292,00	1	148	BM140209	12,32	6	87	CH108	41,39	1	126	CR0001/9	2,84	10	126
92099992-999	20,00	1	134, 147, 148	BM140308	17,99	6	87	CJ545FM	13,42	24	125	CR0002/14	2,84	10	126
92099999-919	20,00	1	134, 147, 148	BM140407	14,32	6	87	CJ545U	8,92	24	125	CR0002/2	2,89	10	126
92099999-929	20,00	1	134, 147, 148	BM140803	18,00	6	87	CJ645FM	14,91	24	125	CR0002/6	2,89	10	126
98820318-999	29,00	1	151	BM150109	5,70	8	87	CJ645U	12,26	24	125	CR0002/9	2,84	10	126
98820416-999	34,00	1	151	BM150208	9,83	8	87	CJ645UF	13,87	1	125	CR0003/14	3,85	10	126
98820512-999	57,00	1	151, 152	BM150307	5,70	8	87	CJ6A45F	15,07	24	125	CR0003/2	3,86	10	126
98821315-999	34,00	1	152	BM150406	9,83	8	87	CL118154	18,48	6	87	CR0003/6	3,86	10	126
98821415-999	40,00	1	152	BM516301	23,25	4	87	CL118161	18,48	6	87	CR0003/9	3,85	10	126
98821515-999	63,00	1	152	BM516302	38,54	4	87	CL50F	9,60	5	125	CR0004/14	3,85	10	126
99920259-199	38,00	1	142	BM516305	24,72	4	87	CL50U	6,03	5	125	CR0004/2	3,86	10	126
99920279-999	5,90	1	142	BM516306	39,61	4	87	CL510303	15,39	48	87	CR0004/6	3,86	10	126
99920509-199	43,00	1	143	BM711201	11,54	8	87	CL51F	11,11	5	125	CR0004/9	3,85	10	126
99920529-999	6,60	1	143	BM711301	11,93	8	87	CL51U	7,17	5	125	CR1020/14	14,90	5	126
99920919-999	25,00	1	151	BM711401	12,47	8	87	CL52F	13,04	5	125	CR1020/9	14,90	5	126
99921109-199	27,00	1	136	BM711402	15,19	8	87	CL52U	9,11	5	104, 125	CR2010/14	13,46	5	127
99921919-999	32,00	1	152	BM711501	14,55	8	87	CL53F	15,12	5	125	CR2010/6	13,47	5	127
99931109-199	25,00	1	152	BM711601	15,08	8	87	CL53U	11,25	5	125	CR2010/9	13,46	5	127
99981000-900	61,00	1	136, 142, 151	BM712301	14,13	8	87	CL55F	19,27	5	125	CR2020/14	20,60	5	104, 127
99981000-977	61,00	1	136, 142, 151	BM712302	9,26	8	87	CL55U	15,12	5	125	CR2020/6	20,61	5	104, 127
AC11	1,07	20	111	BM712303	15,90	8	87	CL60F	10,10	5	125	CR2020/9	20,60	5	104, 127
AC33/6	1,10	20	111	BM712400	14,23	8	87	CL60U	9,11	5	125	CR2030/14	27,13	5	127
ACSE	5,55	10	107	BM712401	17,29	6	87	CL610305	23,00	6	87	CR2030/6	27,14	5	127
ALK1100/8	259,66	1	108	BM712402	16,57	8	87	CL610306	19,51	6	87	CR2030/9	27,13	5	127
ALK115/8	97,88	1	108	BM712403	23,09	8	87	CL611201	4,47	10	87	CR2040/14	33,69	5	127
ALK116/8	100,04	1	108	BM712501	15,32	8	87	CL612201	3,89	10	87	CR2040/6	33,70	5	127
ALK117/8	101,58	1	108	BM712503	16,88	8	87	CL612202	4,44	10	87	CR2040/9	33,69	5	127
ALK2200/8	419,02	1	109	BM712600	17,18	8	87	CL61F	11,54	5	125	CR2050/14	40,24	5	127
				BM712601	20,81	6	87	CL61U	10,25	5	125	CR2050/6	40,25	5	127
				BM712602	18,90	8	87	CL62F	13,75	5	125	CR2050/9	40,24	5	127

ARTÍCULO	PRECIO €	PIEZAS CAJA	PÁGINA	ARTÍCULO	PRECIO €	PIEZAS CAJA	PÁGINA	ARTÍCULO	PRECIO €	PIEZAS CAJA	PÁGINA	ARTÍCULO	PRECIO €	PIEZAS CAJA	PÁGINA
CR2060/14	46,79	5	127	F2036/14	226,98	1	125	K06/14 ^N	9,13	10	110	K102D/8	14,35	10	114
CR2060/6	46,82	5	127	F2105/14	100,47	1	124	K06/6 ^N	8,95	10	110	K102D/9	11,78	10	114
CR2060/9	46,79	5	127	F2105/6	100,47	1	124	K06/9 ^N	8,95	10	110	K103/14	1,88	20	114
CR2070/14	53,36	5	127	F2106/14	115,61	1	124	K069/14	3,83	20	113	K103/9	1,86	20	114
CR2070/6	53,37	5	127	F2108/14	142,11	1	124	K069/9	3,72	20	113	K103B/14	24,38	1	114
CR2070/9	53,36	5	127	F2109/14	148,46	1	124	K07/14 ^N	10,88	10	110	K103B/8	26,84	1	114
CR2080/14	59,94	5	127	F2109/6	148,46	1	124	K07/9 ^N	10,67	10	110	K103B/9	24,14	1	114
CR2080/6	59,95	5	127	F2115/14	119,73	1	124	K075/14	3,83	20	113	K104/14	5,94	10	114
CR2080/9	59,94	5	127	F2116/14	125,99	1	124	K075/9	3,72	20	113	K104/9	5,88	10	114
CR4020/14	18,68	5	105, 126	F2118/14	149,11	1	124	K076/14	3,83	20	113	K104A/14	9,71	5	114
CR4020/6	19,13	5	105, 126	F2118/6	149,11	1	124	K076/9	3,72	20	113	K104A/8	11,21	5	114
CR4020/9	18,68	5	105, 126	F2126/14	187,99	1	124	K08/14 ^N	14,64	10	110	K104A/9	9,50	5	114
CR5001/14	5,11	5	126	F2136/14	236,54	1	124	K08/9 ^N	14,35	10	110	K105/14	2,18	20	115
CR5002/14	5,11	5	126	G201	26,83	1	100, 108	K080/14	3,16	20	112	K105/8	5,91	20	115
CR5003/14	9,39	5	126	G301C	28,10	1	100, 108	K080/9	3,11	20	112	K105/9	2,12	20	115
CR5004/14	9,39	5	126	G401	35,20	1	100, 108	K085/14	3,83	20	113	K105B/14	24,38	1	114
CR6020/14	22,52	5	104, 105, 126	H114	171,21	1	104	K085/9	3,72	20	113	K105B/8	26,84	1	114
CR6020/6	22,59	5	104, 105, 126	H114U	107,57	1	104	K087/14	3,83	20	113	K105B/9	24,14	1	114
CR6020/9	22,52	5	104, 105, 126	IL230061	27,55	4	88	K087/9	3,72	20	113	K105C/14 ^N	54,45	1	115
CR7312/14	6,25	10	127	IL230062	32,13	4	88	K09/14	13,26	10	110	K105C/9 ^N	53,40	1	115
EX922501 ^N	97,08	1	88	IL416101	12,22	4	88	K09/9	13,00	10	110	K106A/14	61,16	1	111
EX922601 ^N	166,00	1	88	IL416102	20,22	4	88	K095F/9	14,73	10	112	K106A/8	79,52	1	111
F1005/14	87,98	1	124	IL416103	27,35	4	88	K095U/9	10,96	10	112	K106A/9	60,41	1	111
F1006/14	107,84	1	124	IL416104	40,79	4	88	K096F/9	18,20	10	111	K107A/14	143,01	1	111
F1008/14	121,04	1	124	IL416105	21,84	4	88	K096U/9	15,58	10	111	K107A/8	186,19	1	111
F1009/14	142,11	1	124	IL416106	38,52	4	88	K10/14	3,33	20	104, 115	K107A/9	141,51	1	111
F1015/14	100,47	1	124	IL416107	49,37	4	88	K10/8	7,83	20	104, 115	K109/14	1,80	10	109, 110
F1016/14	110,24	1	124	IL416108	74,24	2	88	K10/9	3,24	20	115	K109/8	5,96	5	109, 110
F1018/14	138,70	1	124	IL416109	55,64	4	88	K100/14	1,88	20	114	K109/9	1,77	10	109, 110
F1026/14	171,64	1	124	IL416111	68,58	4	88	K100/9	1,86	20	114	K11/14	8,23	10	110
F1036/14	226,98	1	124	IL416112	59,78	4	88	K100A/14	8,97	10	114	K11/27	8,27	10	110
F1105/14	115,61	1	124	IL416113	103,38	2	88	K100A/8	10,79	10	114	K11/6	8,10	10	110
F1106/14	125,29	1	124	K01/14	5,24	10	111	K100A/9	8,80	10	114	K11/7	8,27	10	110
F1106/6	125,29	1	124	K01/6	5,14	10	111	K100B/14	29,33	1	114	K11/8	11,73	10	110
F1108/14	142,11	1	124	K01/7	5,26	10	111	K100B/8	31,96	1	114	K11/9	8,10	10	110
F1109/14	148,46	1	124	K01/8	8,12	10	111	K100B/9	29,03	1	114	K110/14	2,06	10	109, 110
F1115/14	119,73	1	124	K01/9	5,14	10	111	K100C/14 ^N	45,30	1	115	K110/8	6,83	5	109, 110
F1116/14	125,99	1	124	K02/14	5,24	10	111	K100C/9 ^N	44,40	1	115	K110/9	2,03	10	109, 110
F1118/14	149,11	1	124	K02/6	5,14	10	111	K101/14	1,88	20	114	K112/14	2,71	10	109
F1126/14	187,99	1	124	K02/8	8,12	10	111	K101/9	1,86	20	114	K112/8	8,99	5	109
F1136/14	236,54	1	124	K02/9	5,14	10	111	K101B/14	23,66	1	114	K112/9	2,67	10	109
F2005/14	87,98	1	125	K03/14 ^N	12,75	10	110	K101B/8	26,04	1	114	K113/14	2,38	10	110
F2006/14	107,84	1	125	K03/9 ^N	12,50	10	110	K101B/9	23,42	1	114	K113/8	7,92	5	110
F2006/6	107,84	1	125	K04/14 ^N	10,88	10	110	K102/14	1,88	20	114	K113/9	2,31	10	110
F2008/14	121,04	1	125	K04/9 ^N	10,67	10	110	K102/9	1,86	20	114	K114/14	2,71	10	110
F2008/6	121,04	1	125	K045/14	3,83	20	113	K102B/14	8,86	10	113	K114/8	8,99	5	110
F2009/14	142,11	1	125	K045/9	3,72	20	113	K102B/8	11,08	10	113	K114/9	2,67	10	110
F2015/14	139,01	1	125	K05/14 ^N	11,21	10	110	K102B/9	8,67	10	113	K115/14	2,38	10	110
F2016/14	110,24	1	125	K05/6 ^N	10,99	10	110	K102C/14	9,16	10	113	K115/8	7,92	5	110
F2018/14	149,11	1	125	K05/9 ^N	10,99	10	110	K102C/8	11,58	10	113	K115/9	2,31	10	110
F2026/14	171,64	1	125	K054/14	3,83	20	113	K102C/9	9,00	10	113	K12/14 ^N	15,20	10	110
				K054/9	3,72	20	113	K102D/14	12,02	10	114	K12/6 ^N	15,50	10	110

RELACIÓN NUMÉRICA DE ARTÍCULOS

ÍNDICE GENERAL - RELACIÓN NUMÉRICA POR ARTÍCULO

ARTÍCULO	PRECIO €	PIEZAS CAJA	PÁGINA	ARTÍCULO	PRECIO €	PIEZAS CAJA	PÁGINA	ARTÍCULO	PRECIO €	PIEZAS CAJA	PÁGINA	ARTÍCULO	PRECIO €	PIEZAS CAJA	PÁGINA
K12/9	14,90	10	110	K129C/9	43,30	1	115	K33/9	22,80	10	110	K96FF/14	21,09	1	115
K120A/14	13,53	10	113	K13/14	23,26	10	110	K34/14	31,31	10	110	K96FF/9	21,00	1	115
K120A/8	17,07	10	113	K13/6	23,72	10	110	K34/6	31,31	10	110	K96U/14	16,15	10	111
K120A/9	13,25	10	113	K13/9	22,80	10	110	K34/9	30,70	10	110	K96U/8	18,18	10	111
K121/14	1,87	20	114, 126	K130A/14	25,70	10	113	K366	2,05	10	110	K96U/9	16,07	10	111
K121/9	1,84	20	114, 126	K130A/8	29,73	10	113	K65/14	4,82	20	113	K96UF/14	18,20	1	115
K121A/14	4,95	10	114, 126	K130A/9	25,23	10	113	K65/9	4,73	20	113	K96UF/9	18,11	1	115
K121A/9	4,90	10	114, 126	K131B/9	30,50	1	114	K66	2,05	20	104, 108, 109, 112, 113	KA045/14	3,35	20	113
K121B/14	5,38	10	114, 126	K132A/14	29,45	1	115	K68/14	4,82	20	113	KA045/9	3,26	20	113
K121B/9	5,33	10	114, 126	K132A/9	28,90	1	115	K68/9	4,73	20	113	KA65/14	4,23	20	113
K122/14	3,28	20	114	K132B/14	44,20	1	115	K68/9	4,73	20	113	KA65/9	4,18	20	113
K122/8	7,54	20	114	K132B/9	43,30	1	115	K69/14	4,82	20	113	KA68/14	4,23	20	113
K122/9	3,25	20	114	K14/14	31,31	10	110	K69/9	4,73	20	113	KA68/9	4,18	20	113
K123B/14	24,38	1	114	K14/6	31,31	10	110	K75/14	4,82	20	113	KA69/14	4,23	20	113
K123B/8	26,84	1	114	K14/9	30,70	10	110	K75/9	4,73	20	113	KA69/9	4,18	20	113
K123B/9	24,14	1	114	K15/14	12,48	10	110	K76/14	4,82	20	113	KA75/14	4,23	20	113
K126C/14	38,81	1	114	K15/9	12,24	10	110	K76/8	7,85	20	113	KA75/9	4,18	20	113
K126C/8	44,08	1	114	K17/14	3,18	20	115	K76/9	4,73	20	113	KA76/14	4,23	20	113
K126C/9	37,68	1	114	K17/8	7,51	20	115	K80/14	4,25	20	112	KA76/8	6,98	20	113
K126D/14	45,25	1	114	K17/9	3,10	20	115	K80/8	8,62	20	112	KA76/9	4,18	20	113
K126D/8	51,38	1	114	K18/14	3,30	20	114, 126	K80/9	4,18	20	112	KA85/14	4,23	20	113
K126D/9	43,90	1	114	K18/9	3,24	20	114, 126	K8095F/14	15,44	10	112	KA85/9	4,18	20	113
K126E/14	45,25	1	114	K18W5/14	5,68	10	115, 126	K8095F/8	17,14	10	112	KA95F/14	15,08	10	112
K126E/8	51,38	1	114	K18W5/9	5,57	10	115, 126	K8095F/9	15,41	10	112	KA95F/8	17,63	10	112
K126E/9	43,90	1	114	K19/14	3,33	20	104, 115	K8095U/14	11,83	10	112	KA95F/9	15,05	10	112
K126F/14	47,58	1	114	K19/9	3,24	20	115	K8095U/8	13,46	10	112	KA95U/14	11,41	10	112
K126F/8	53,38	1	114	K20/14	3,33	20	104, 115	K8095U/9	11,79	10	112	KA95U/8	13,35	10	112
K126F/9	46,42	1	114	K20/9	3,24	20	115	K8096F/14	19,10	10	111	KA95U/9	11,38	10	112
K126G/14	47,58	1	114	K21/14	3,33	20	104, 115	K8096F/8	21,60	10	111	KA96F/14	18,69	10	111
K126G/8	53,38	1	114	K21/9	3,24	20	115	K8096F/9	19,07	10	111	KA96F/8	21,80	10	111
K126G/9	46,42	1	114	K22/14	8,23	10	110	K8096U/14	16,21	10	111	KA96F/9	18,65	10	111
K126H/14	87,22	1	114	K22/27	8,27	10	110	K8096U/8	18,36	10	111	KA96U/14	15,73	10	111
K126H/8	92,35	1	114	K22/6	8,10	10	110	K8096U/9	16,18	10	111	KA96U/8	18,37	10	111
K126H/9	85,47	1	114	K22/7	8,27	10	110	K82/14	4,82	20	113	KA96U/9	15,69	10	111
K126I/14	44,36	1	114	K22/8	11,73	10	110	K82/9	4,73	20	113	KB045/14	4,88	20	113
K126I/8	50,37	1	114	K22/9	8,10	10	110	K85/14	4,82	20	113	KB045/9	4,75	20	113
K126I/9	43,04	1	114	K23/14	13,77	10	110	K85/9	4,73	20	113	KB069/14	4,88	20	113
K128B/14	24,38	1	114	K23/9	13,50	10	110	K87/14	4,82	20	113	KB069/9	4,75	20	113
K128B/8	26,84	1	114	K281/14	2,47	20	113	K87/9	4,73	20	113	KB075/14	4,88	20	113
K128B/9	24,14	1	114	K281/9	2,42	20	113	K95F/14	15,52	10	112	KB075/9	4,75	20	113
K128C/14	28,80	1	115	K301	6,93	10	109	K95F/8	17,51	10	112	KB076/14	4,88	20	113
K128C/9	28,30	1	115	K302	11,41	10	109	K95F/9	15,48	10	112	KB076/9	4,75	20	113
K128D/14	41,60	1	115	K303	7,65	10	110	K95U/14	11,81	10	112	KB080/14	3,49	20	112
K128D/9	40,80	1	115	K304	12,54	10	110	K95U/8	13,35	10	112	KB080/9	3,44	20	112
K128E/14	29,90	1	115	K305A/14	4,38	10	104, 114, 126	K95U/9	11,76	10	112	KB085/14	4,88	20	113
K128E/9	29,50	1	115	K306A/14	5,07	10	114, 126	K96AFF/14	21,26	1	115	KB085/9	4,75	20	113
K128F/14	44,70	1	115	K306A/9	5,00	10	114, 126	K96AFF/9	21,17	1	115	KB095F/9	27,64	10	112
K128F/9	43,90	1	115	K32/14	15,20	10	110	K96AUF/14	18,62	1	115	KB095U/9	19,51	10	112
K129B/14	30,78	1	114	K32/6	15,50	10	110	K96AUF/9	18,53	1	115	KB096F/9	34,35	10	112
K129B/8	32,94	1	114	K32/9	14,90	10	110	K96F/14	19,17	10	111	KB096U/9	29,27	10	111
K129B/9	30,50	1	114	K33/14	23,26	10	110	K96F/8	21,58	10	111	KB18/14	3,30	20	114, 126
K129C/14	44,20	1	115	K33/6	23,72	10	110	K96F/9	19,13	10	111	KB18/9	3,24	20	114, 126

ARTÍCULO	PRECIO €	PIEZAS CAJA	PÁGINA	ARTÍCULO	PRECIO €	PIEZAS CAJA	PÁGINA	ARTÍCULO	PRECIO €	PIEZAS CAJA	PÁGINA	ARTÍCULO	PRECIO €	PIEZAS CAJA	PÁGINA
KB18A/14	10,70	5	114, 126	KF04B/9	23,61	5	111	KFC205/14	24,00	1	106	KLS02/9	11,05	10	111
KB65/14	7,53	20	113	KF04C/14	106,31	5	111	KFC205/9	23,70	1	106	KM301/8	86,07	1	109
KB65/9	7,41	20	113	KF04C/8	104,77	5	111	KFC206/14	25,92	1	106	KM401/8	104,28	1	109
KB68/14	7,53	20	113	KF04C/9	106,19	5	111	KFC206/9	25,61	1	106	KM601/8	130,17	1	109
KB68/9	7,41	20	113	KF1201/8	43,95	5	107	KFC207/14	27,88	1	106	KMA301/8	74,22	1	109
KB69/14	7,53	20	113	KF200/1	57,98	1	107	KFC207/9	27,56	1	106	KMA401/8	81,98	1	109
KB69/9	7,41	20	113	KF201/8	17,75	5	107	KFC208/14	29,86	1	106	KR245/14	3,70	20	107
KB72/9	4,75	20	113	KF300C/1	63,07	1	107	KFC208/9	29,56	1	106	KR245/9	3,56	20	107
KB75/14	7,53	20	113	KF400/1	68,30	1	107	KFC209/14	31,91	1	106	KR445/14	6,68	10	107
KB75/9	7,41	20	113	KF401/8	21,80	5	107	KFC209/9	31,55	1	106	KR445/9	6,51	10	107
KB76/14	7,53	20	113	KF601/8	27,85	5	107	KFC210/14	34,02	1	106	KS11/14	12,42	10	110
KB76/8	9,09	20	113	KF801/8	36,40	5	107	KFC210/9	33,66	1	106	KS11/6	12,17	10	110
KB76/9	7,41	20	113	KFC103020LP1/14	52,35	1	106	KFC231/14	18,30	1	105	KS11/8	17,30	10	110
KB80/14	6,29	20	112	KFC103020LP1/9	51,78	1	106	KFC232/14	21,76	1	105	KS11/9	12,17	10	110
KB80/8	14,44	20	112	KFC103LP1/14	22,38	1	106	KFC234/14	25,70	1	106	KS22/14	12,42	10	110
KB80/9	6,19	20	112	KFC103LP1/9	22,15	1	106	KFC236/14	29,78	1	106	KS22/6	12,17	10	110
KB8095U/14	21,92	10	112	KFC104020LP2/14	54,70	1	106	KFC2411/14	31,99	1	106	KS22/9	12,17	10	110
KB8095U/8	25,01	10	112	KFC104020LP2/9	54,14	1	106	KFC2421/14	42,67	1	106	KSE0/23/71	98,20	1	107
KB8095U/9	21,87	10	112	KFC104030LP1/14	60,64	1	106	KFC2422/14	138,64	1	106	KSE0/23/72	98,20	1	107
KB8096U/14	30,72	10	111	KFC104030LP1/9	59,98	1	106	KFC2446U/14	162,57	1	106	KSE01/23/71	117,69	1	107
KB8096U/8	34,86	10	111	KFC104LP1/14	24,17	1	106	KFP101/14	26,53	1	104	KSE01/23/72	117,69	1	107
KB8096U/9	30,67	10	111	KFC104LP1/9	23,95	1	106	KFP102/14	28,62	1	104	KSE01SEC/23/71	128,90	1	107
KB85/14	7,53	20	113	KFC104LP2/14	26,44	1	106	KFP103/14	30,94	1	104	KSE01SEC/23/72	128,90	1	107
KB85/9	7,41	20	113	KFC104LP2/9	26,19	1	106	KFP104/14	33,34	1	104	KSE0SEC/23/71	126,70	1	107
KB87/14	7,53	20	113	KFC104NL1/14	27,35	1	106	KFP105/14	36,13	1	104	KSE0SEC/23/72	126,70	1	107
KB87/9	7,41	20	113	KFC104NL1/9	27,08	1	106	KFP106/14	38,41	1	104	KSE1/23/71	103,95	1	107
KB95F/14	30,27	10	112	KFC105022LP1/14	86,53	1	106	KFP107/14	40,32	1	104	KSE1/23/72	103,95	1	107
KB95F/8	32,90	10	112	KFC105022LP1/9	85,64	1	106	KFP108/14	42,98	1	104	KSE10U/23/71	125,52	1	107
KB95F/9	29,35	10	112	KFC105040LP1/14	68,94	1	106	KGE170/23	28,93	1	107	KSE10U/23/72	125,52	1	107
KB95U/14	21,26	10	112	KFC105040LP1/9	68,16	1	106	KGE170TF/23	41,73	1	107	KSE15U/23/71	133,43	1	107
KB95U/8	24,45	10	112	KFC105LP1/14	26,21	1	106	KGH401/8	124,90	1	100	KSE15U/23/72	133,43	1	107
KB95U/9	21,83	10	112	KFC105LP1/9	25,95	1	106	KGH601/8	139,90	1	100	KSE15USEC/23/71	159,67	1	107
KB96F/14	37,58	10	111	KFC105NL2/14	32,76	1	106	KGH801/8	158,95	1	100	KSE15USEC/23/72	159,67	1	107
KB96F/8	42,43	10	111	KFC105NL2/9	32,46	1	106	KL01/14	8,59	10	111	KSE16U/23/71	138,68	1	107
KB96F/9	36,47	10	111	KFC106040LP2/14	71,29	1	106	KL01/6	8,45	10	111	KSE16U/23/72	138,68	1	107
KB96U/14	29,69	10	111	KFC106040LP2/9	70,50	1	106	KL01/7	8,66	10	111	KSE16USEC/23/71	158,04	1	107
KB96U/8	34,20	10	111	KFC106LP2/14	30,39	1	106	KL01/8	12,26	10	111	KSE16USEC/23/72	158,04	1	107
KB96U/9	30,52	10	111	KFC106LP2/9	30,10	1	106	KL01/9	8,45	10	111	KSE1SEC/23/71	131,68	1	107
KCFC01/24	2,98	20	105	KFC106NL1/14	31,29	1	106	KL02/14	8,59	10	111	KSE1SEC/23/72	131,68	1	107
KCFC02/24	4,08	20	105	KFC106NL1/9	31,00	1	106	KL02/6	8,45	10	111	KSE4/23/71	107,69	1	107
KCFC03/24	2,98	20	105	KFC107LP1/14	30,10	1	106	KL02/9	8,45	10	111	KSE4/23/72	107,69	1	107
KCFC04/24	2,98	20	105	KFC107LP1/9	29,80	1	106	KL04/14	10,51	10	110	KSF1	9,16	1	105
KCFC05/24	2,98	20	105	KFC107NL2/14	36,67	1	106	KL04/9	10,29	10	110	KSF131/8	41,35	1	105
KCFC06/24	4,43	20	105	KFC107NL2/9	36,31	1	106	KL05/14	8,16	10	115	KSF132/8	45,30	1	105
KF03/14	13,83	10	111	KFC108LP2/14	34,38	1	106	KL05/9	8,01	10	115	KSF134/8	49,64	1	105
KF03/8	15,40	10	111	KFC108LP2/9	34,05	1	106	KLS01/14	11,27	10	111	KSF136/8	54,39	1	105
KF03/9	13,58	10	111	KFC202/14	18,59	1	106	KLS01/6	11,05	10	111	KSF2	14,64	1	105
KF04A/14	25,18	5	111	KFC202/9	18,38	1	106	KLS01/7	11,32	10	111	KSF3	30,12	1	105
KF04A/8	35,13	5	111	KFC203/14	20,16	1	106	KLS01/8	16,01	10	111	KSF4	6,14	10	105
KF04A/9	25,05	5	111	KFC203/9	19,91	1	106	KLS01/9	11,05	10	111	KSF5	11,16	1	105
KF04B/14	23,73	5	111	KFC204/14	21,96	1	106	KLS02/14	11,27	10	111	KSF6	33,67	2	105
KF04B/8	33,67	5	111	KFC204/9	21,71	1	106	KLS02/6	11,05	10	111	KSF7	12,26	1	107

RELACIÓN NUMÉRICA DE ARTÍCULOS

ÍNDICE GENERAL - RELACIÓN NUMÉRICA POR ARTÍCULO

ARTÍCULO	PRECIO €	PIEZAS CAJA	PÁGINA	ARTÍCULO	PRECIO €	PIEZAS CAJA	PÁGINA	ARTÍCULO	PRECIO €	PIEZAS CAJA	PÁGINA	ARTÍCULO	PRECIO €	PIEZAS CAJA	PÁGINA
KSF8	5,60	1	107	R450/14	6,91	5	107	TFA904418/8	17,06	5	123	TKA021110/8	43,45	1	120
KSF9	5,60	1	107	R450/9	6,71	5	107	TFA904419/8	22,44	5	123	TKA021113/8	54,74	1	120
KT0100/8	160,26	1	109	RALK001/8	31,22	1	109	TFA965417/8	20,90	1	123	TKA021210/9	27,48	1	119
KT0800/8	140,89	1	109	RALK002/8	37,45	1	109	TFA965418/8	25,01	1	123	TKA021213/9	32,96	1	119
KTA802/8	81,98	1	109	RALK003/8	38,97	1	109	TFA970418/8	26,58	1	123	TKA021216/8	60,83	1	120
KTA804/8	37,77	1	108, 124	RALK004/8	38,97	1	109	TK01103/8	63,15	8	120	TKA021216/9	38,39	1	119
KTA813/8	37,77	1	124	RALK005/8	66,00	1	108	TK01133/8	70,98	8	120	TKA101208/8	26,83	1	118, 122
KTA822/8	37,77	1	124	RALK006/8	66,00	1	108	TK01163/8	77,72	8	120	TKA101208/9	13,00	1	117, 120
KTA8229/8	37,77	1	124	RALK007/8	47,57	1	108	TK02103/9	42,39	8	119	TKA101212/8	41,93	1	122
KTA831/8	37,77	1	124	RALK008/8	47,57	1	108	TK02133/9	46,82	8	119	TKA101212/9	20,61	1	117, 121
KTA904/8	12,03	1	124	RALK009/8	7,83	1	108	TK02163/9	49,94	8	119	TKA101214/8	46,75	1	123
KTC300/8	95,80	1	109	RALK010/8	11,85	1	108	TK11071/8	61,49	16	122	TKA101214/9	21,68	1	117, 121
KTC400/8	114,52	1	109	RALK011/8	22,56	1	108	TK11081/8	66,43	12	122	TKA101307/8	29,85	1	122
KTC600/8	136,95	1	109	RALK012/8	18,14	1	108	TK11102/8	74,32	12	122	TKA102208/8	23,52	1	118, 122
KTL202	95,44	1	103	RALK013/8	39,75	1	109	TK11122/8	99,92	8	122	TKA102208/9	11,71	1	117, 120
KTL203	98,49	1	103	RALK014/8	39,75	1	109	TK11143/8	104,39	6	123	TKA102307/8	19,04	1	122
KTL204	101,53	1	103	RKS001/71	20,62	1	107	TK12081/9	17,29	12	120	TKA103208/8	23,52	1	118, 122
KTL205	104,54	1	103	RKS001/72	20,62	1	107	TK12102/9	21,09	12	121	TKA103208/9	11,71	1	117, 120
KTL206	107,57	1	103	RKS003	2,56	1	107	TK12122/9	32,16	12	121	TKA103307/8	18,87	1	122
KTL212	140,05	1	103	RKS004	4,87	1	107	TK12143/9	34,84	6	121	TKA104207/24	9,51	5	122
KTL216U	278,43	1	103	RKS005/71	4,34	1	107	TKA002210/8	25,85	1	120	TKA104307/8	10,04	5	122
KTL8/14	6,02	1	104, 105, 126	RKS005/72	4,34	1	107	TKA002210/9	18,00	1	119	TKA105208/8	8,36	5	118, 122
KTLA1/14	18,22	1	103	RSF001/1	28,56	1	101	TKA002213/8	30,81	1	120	TKA105208/9	3,82	5	117, 120
KTLA1/31	36,80	1	103	RSF001/14	28,56	1	101	TKA002213/9	21,45	1	119	TKA105212/8	11,61	5	123
KTLA2	109,80	1	104	RSF002/1	31,28	1	101	TKA002216/8	34,99	1	120	TKA105212/9	5,67	5	117, 121
KTLA3	31,85	1	104	RSF002/14	31,28	1	101	TKA002216/9	23,90	1	119	TKA105214/8	13,07	5	123
KTLA4	43,96	1	104	RSF003/1	33,88	1	101	TKA003210/8	25,56	1	120	TKA105214/9	5,90	5	118, 121
KTLA5	43,96	1	104	RSF003/14	33,88	1	101	TKA003210/9	16,50	1	119	TKA105307/8	9,47	1	122
KTLA6	31,85	1	104	RSF004/1	35,63	1	101	TKA003213/8	29,03	1	120	TKA106208/8	7,57	1	118, 122, 123
KTLA7	31,85	1	104	RSF004/14	35,63	1	101	TKA003213/9	19,64	1	119	TKA106208/9	3,20	1	117, 118, 120, 121
KTLE205	181,80	1	103	RSF006/1	41,75	1	101	TKA003216/8	31,40	1	120	TKA106210/8	8,35	1	118, 122, 123
KTLE216U	334,34	1	103	RSF006/14	41,75	1	101	TKA003216/9	22,72	1	119	TKA106210/9	3,77	1	117, 118, 121
MD45	0,77	50	98, 112	RTP001/8	85,66	1	117	TKA004210/8	9,80	5	120	TKA106212/8	8,40	1	123
MD54	0,77	50	98, 112	RTP002/8	92,61	1	123	TKA004210/9	6,87	5	119	TKA106212/9	4,39	1	117, 118, 121
MD63	0,77	50	98, 112	RTT001/8	43,35	1	123	TKA004213/8	12,55	5	120	TKA107/9	4,59	1	118, 120, 121
MD64	0,77	50	98, 112	RTT001/9	23,39	1	122	TKA004213/9	8,17	5	119	TKA108	7,40	1	118, 119, 120, 121, 122, 123
MD67	0,77	50	98, 112	RTT002/8	34,39	1	120	TKA004216/8	13,13	5	120	TKA109	11,82	1	118, 119, 121, 122, 123
MD68	0,77	50	98, 112	RTT003/8	53,90	1	117	TKA004216/9	8,84	5	119	TKA1305502/8	10,58	5	118, 122
MD69	0,77	50	98, 112	S10002038-130	118,36	1	62	TKA005210/8	7,17	5	120	TKA1305502/9	4,23	5	121
MD79	0,77	50	98, 112	S10002038-138	118,36	1	62	TKA005210/9	5,09	5	119	TKA1305505/8	33,42	1	118, 122
MD85	0,77	50	98, 112	S10002038-230	127,07	1	62	TKA005213/8	11,16	5	120	TKA1305505/9	14,95	1	117, 121
MU100101	21,96	6	88	S10002038-238	127,07	1	62	TKA005213/9	6,81	5	119	TKA1305506/8	24,20	1	118, 122
MU112201	5,51	6	88	TC250/0	37,89	1	104, 105, 124	TKA005216/8	12,00	5	120	TKA1305506/9	14,07	1	117, 121
MU133201	12,48	6	88	TC251/0	116,18	1	124	TKA005216/9	7,56	5	119	TKA1305507/8	24,20	1	118, 122
MU143201	25,01	6	88	TCA2501	5,18	1	124	TKA0061/8	26,96	1	120	TKA1305507/9	13,36	1	117, 121
MU222215	9,80	6	88	TF11172/8	32,96	8	123	TKA0062/9	17,81	1	119	TKA1305508/8	8,66	5	118, 122
MU264103	8,32	6	88	TF11183/8	50,53	8	123	TKA011110/8	43,45	1	120	TKA1305508/9	4,27	5	117, 121
PL428201	45,00	4	88	TF11193/8	162,53	4	123	TKA011113/8	54,74	1	120				
PL728241	67,50	2	88	TF21172/8	38,06	11	123	TKA011210/9	27,48	1	119				
R250/14	3,94	10	107	TF21183/8	55,28	11	123	TKA011213/9	32,96	1	119				
R250/9	3,81	10	107	TFA904417/8	10,31	5	123	TKA011216/8	60,83	1	120				
								TKA011216/9	38,39	1	119				

ARTÍCULO	PRECIO €	PIEZAS CAJA	PÁGINA	ARTÍCULO	PRECIO €	PIEZAS CAJA	PÁGINA	ARTÍCULO	PRECIO €	PIEZAS CAJA	PÁGINA	ARTÍCULO	PRECIO €	PIEZAS CAJA	PÁGINA
TKA1605502/8	12,31	5	122	TMA105202/9	2,46	12	116								
TKA1605502/9	4,88	5	121	TMA105203/9	2,86	12	116								
TKA1605506/8	27,07	1	122	TMA105205/9	3,16	6	116								
TKA1605506/9	15,62	1	117, 121	TMA106201/9	1,46	24	116								
TKA1605507/8	27,07	1	122	TMA106202/9	3,42	12	116								
TKA1605507/9	15,62	1	117, 121	TMA106203/9	3,57	12	116								
TKA1855502/8	13,95	5	123	TMA106205/9	3,16	6	116								
TKA1855502/9	5,37	5	121	TMA107205/9	0,85	20	116								
TKA1855506/8	36,67	1	123	TMA201106/8	29,97	1	116								
TKA1855506/9	18,21	1	117, 121	TMA202104/8	28,91	1	116								
TKA1855507/8	36,49	1	123	TMA202406/24	20,16	1	116								
TKA1855507/9	16,53	1	118, 121	TMA203104/8	27,47	1	116								
TKA901/9	2,26	20	123	TMA203406/24	18,91	1	116								
TKA902	4,70	8	123	TMA204106/8	8,96	5	116								
TKA903	2,14	10	116, 123	TMA204404/8	6,77	5	116								
TKA904	2,14	10	116, 119, 123	TS10/14	11,12	5	104, 105								
TKA905502/8	9,98	5	118, 122	TS10/8	22,16	5	104, 105								
TKA905502/9	4,00	5	120	TS13055/8	78,33	12	118								
TM1022/19	4,06	96	116	TS13055/9	24,26	12	117								
TM1022/9	1,46	96	116	TS16055/9	28,54	12	117								
TM12021/19	8,15	60	116	TS18555/9	34,36	8	117								
TM12021/9	3,24	60	116	TS9055/8	62,12	12	118								
TM12022/19	9,44	60	116	TS9055/9	16,16	12	117								
TM12022/9	4,19	60	116	TSA001	4,54	24	118, 119								
TM12031/19	12,86	54	116	TSA002	1,50	10	118, 119								
TM12031/9	4,92	54	116	TSA003	5,30	1	118								
TM12032/19	14,93	54	116	TSA007	9,78	5	119								
TM12032/9	5,62	54	116	TSA008	6,14	20	118								
TM12051/19	21,19	24	116	TSA1305501	1,48	20	117								
TM12051/9	9,03	24	116	TSA1305502/9	5,08	5	117								
TM12052/19	24,61	24	116	TSA1305503/9	5,85	10	118								
TM12052/9	9,27	24	116	TSA1305504/9	6,10	10	118								
TM21042/8	51,64	16	116	TSA1605501	1,79	20	117								
TM21061/8	57,76	16	116	TSA1605502/9	6,07	5	117								
TMA101201/9	1,12	24	116	TSA1605503/9	6,57	10	118								
TMA101202/9	2,40	12	116	TSA1605504/9	7,29	10	118								
TMA101203/9	2,98	12	116	TSA1855501	2,09	20	117								
TMA101205/9	6,94	6	116	TSA1855502/9	6,71	5	118								
TMA102201/9	1,24	24	116	TSA905501	1,12	20	117								
TMA102202/9	2,73	12	116	TSA905502/9	4,00	5	117								
TMA102203/9	3,36	12	116	TSA905503/9	5,65	10	118								
TMA102205/9	6,99	6	116	TSA905504/9	5,85	10	118								
TMA103201/9	1,18	24	116												
TMA103202/9	2,68	12	116												
TMA103203/9	3,30	12	116												
TMA103205/9	6,99	6	116												
TMA104201/9	1,19	24	116												
TMA104202/9	2,66	12	116												
TMA104203/9	3,32	12	116												
TMA104205/9	3,44	6	116												
TMA105201/9	1,09	24	116												



TARIFA
GENERAL
N° 105

DESCRIPCIÓN

ARTÍCULO PRECIO € PIEZAS
Recomendado CAJA

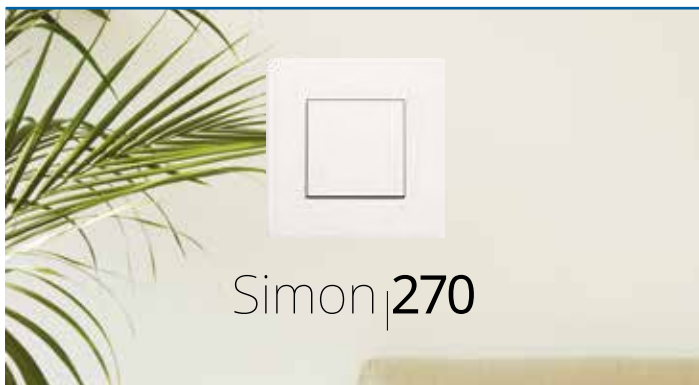

DESCRIPCIÓN

ARTÍCULO PRECIO € PIEZAS
Recomendado CAJA

	Marco estética icon para mecanismos IP44 1 elemento	27192610-090	4,87	1
		27192610-091	10,41	1
		27192610-093	6,10	1
		27192610-094	10,41	1
		27192610-095	10,41	1
		27192610-096	10,41	1
		27192610-097	10,41	1
		27192610-098	6,10	1
	N 27192610-190	6,10	1	

COMPOSICIÓN

	Marco 2 elementos: 1 clean schuko y 1 módulo	27190620-090	4,94	5
		27190620-091	18,25	1
		27190620-093	7,89	1
		27190620-094	18,25	1
		27190620-095	18,25	1
		27190620-096	18,25	1
		27190620-097	18,25	1
		27190620-098	7,89	5
	N 27190620-190	7,89	5	

	Marco 3 elementos: 1 clean schuko y 2 módulos	27190630-090	7,60	5
		27190630-091	28,06	1
		27190630-093	12,16	1
		27190630-094	28,06	1
		27190630-095	28,06	1
		27190630-096	28,06	1
		27190630-097	28,06	1
		27190630-098	12,16	1
	N 27190630-190	12,16	1	

	Marco 3 elementos: 2 clean schuko y 1 módulo	27193630-090	7,60	5
		27193630-091	28,06	1
		27193630-093	12,16	1
		27193630-094	28,06	1
		27193630-095	28,06	1
		27193630-096	28,06	1
		27193630-097	28,06	1
		27193630-098	12,16	1
	N 27193630-190	12,16	1	

	Marco 4 elementos: 2 clean schuko y 2 módulos	27190640-090	10,25	1
		27190640-091	37,90	1
		27190640-093	16,42	1
		27190640-094	37,90	1
		27190640-095	37,90	1
		27190640-096	37,90	1
		27190640-097	37,90	1
		27190640-098	16,42	1
	N 27190640-190	16,42	1	

ESTÉTICA MÍNIMA

	Marco estética mínima 1 elemento	27101610-090	3,42	10
		27101610-091	9,16	5
		27101610-093	6,49	5
		27101610-094	9,16	5
		27101610-095	9,16	5
		27101610-096	9,16	5
		27101610-097	9,16	5
		27101610-098	5,37	10
	N 27101610-190	5,37	10	

	Marco estética mínima 2 elementos	27101620-090	5,64	10
		27101620-091	17,83	5
		27101620-093	11,59	5
		27101620-094	17,83	5
		27101620-095	17,83	5
		27101620-096	17,83	5
		27101620-097	17,83	5
		27101620-098	9,15	10
	N 27101620-190	9,15	10	

MARCOS

	Marco estética icon 1 elemento	27000610-090	2,13	20
		27000610-091	7,16	5
		27000610-093	4,22	5
		27000610-094	7,16	5
		27000610-095	7,16	5
		27000610-096	7,16	5
		27000610-097	7,16	5
		27000610-098	3,59	10
	N 27000610-190	3,59	10	

	Marco estética icon 2 elementos	27000620-090	4,60	10
		27000620-091	13,90	5
		27000620-093	7,28	5
		27000620-094	13,90	5
		27000620-095	13,90	5
		27000620-096	13,90	5
		27000620-097	13,90	5
		27000620-098	6,79	10
	N 27000620-190	6,79	10	

	Marco estética icon 3 elementos	27000630-090	7,65	5
		27000630-091	21,38	1
		27000630-093	11,21	1
		27000630-094	21,38	1
		27000630-095	21,38	1
		27000630-096	21,38	1
		27000630-097	21,38	1
		27000630-098	10,18	5
	N 27000630-190	10,18	5	

	Marco estética icon 4 elementos	27000640-090	10,48	1
		27000640-091	30,33	1
		27000640-093	15,88	1
		27000640-094	30,33	1
		27000640-095	30,33	1
		27000640-096	30,33	1
		27000640-097	30,33	1
		27000640-098	14,44	1
	N 27000640-190	14,44	1	



	Marco estética icon 5 elementos	27000650-090	10,84	1
		27000650-091	41,02	1
		27000650-093	21,48	1
		27000650-094	41,02	1
		27000650-095	41,02	1
		27000650-096	41,02	1
		27000650-097	41,02	1
		27000650-098	19,52	1
	N 27000650-190	19,52	1	

COLECCIONES DE MECANISMOS

DESCRIPCIÓN	ARTÍCULO	PRECIO € Recomendado	PIEZAS CAJA
 Marco estética mínima 3 elementos	27101630-090	8,62	5
	27101630-091	27,44	1
	27101630-093	17,54	1
	27101630-094	27,44	1
	27101630-095	27,44	1
	27101630-096	27,44	1
	27101630-097	27,44	1
	27101630-098	13,87	1
	N 27101630-190	13,87	1

DESCRIPCIÓN	ARTÍCULO	PRECIO € Recomendado	PIEZAS CAJA
 Marco estética mínima para clean schuko 5 elementos	27110650-090	20,54	1
	27110650-091	38,31	1
	27110650-093	31,79	1
	27110650-094	38,31	1
	27110650-095	38,31	1
	27110650-096	38,31	1
	27110650-097	38,31	1
	27110650-098	26,45	1
	N 27110650-190	26,45	1





ESTÉTICA MÍNIMA VERTICAL

 Marco estética mínima vertical 2 elementos	27111620-090	5,21	5
	27111620-091	17,83	5
	27111620-093	13,38	5
	27111620-094	17,83	5
	27111620-095	17,83	5
	27111620-096	17,83	5
	27111620-097	17,83	5
	27111620-098	8,34	5
	N 27111620-190	8,34	5
 Marco estética mínima vertical 3 elementos	27111630-090	8,02	5
	27111630-091	27,44	1
	27111630-093	18,12	1
	27111630-094	27,44	1
	27111630-095	27,44	1
	27111630-096	27,44	1
	27111630-097	27,44	1
	27111630-098	12,84	1
	N 27111630-190	12,84	1

 Marco estética mínima 2 elementos: 1 clean schuko y 1 módulo estrecho	27191620-090	4,94	5
	27191620-091	18,25	1
	27191620-093	7,89	1
	27191620-094	18,25	1
	27191620-095	18,25	1
	27191620-096	18,25	1
	27191620-097	18,25	1
	27191620-098	7,89	5
	N 27191620-190	7,89	5

 Marco estética mínima 3 elementos: 1 clean schuko y 2 módulos estrechos	27191630-090	7,60	5
	27191630-091	28,06	1
	27191630-093	12,16	1
	27191630-094	28,06	1
	27191630-095	28,06	1
	27191630-096	28,06	1
	27191630-097	28,06	1
	27191630-098	12,16	1
	N 27191630-190	12,16	1

ESTÉTICA MÍNIMA PARA CLEAN SCHUKO

 Marco estética mínima para clean schuko 1 elemento	27110610-090	5,02	10
	27110610-091	12,29	5
	27110610-093	8,20	5
	27110610-094	12,29	5
	27110610-095	12,29	5
	27110610-096	12,29	5
	27110610-097	12,29	5
	27110610-098	6,78	10
	N 27110610-190	6,78	10
 Marco estética mínima para clean schuko 2 elementos	27110620-090	8,69	10
	27110620-091	15,65	5
	27110620-093	12,50	5
	27110620-094	15,65	5
	27110620-095	15,65	5
	27110620-096	15,65	5
	27110620-097	15,65	5
	27110620-098	10,94	10
	N 27110620-190	10,94	10
 Marco estética mínima para clean schuko 3 elementos	27110630-090	12,08	5
	27110630-091	23,73	1
	27110630-093	18,57	1
	27110630-094	23,73	1
	27110630-095	23,73	1
	27110630-096	23,73	1
	27110630-097	23,73	1
	27110630-098	15,56	1
	N 27110630-190	15,56	1
 Marco estética mínima para clean schuko 4 elementos	27110640-090	15,46	1
	27110640-091	29,44	1
	27110640-093	23,51	1
	27110640-094	29,44	1
	27110640-095	29,44	1
	27110640-096	29,44	1
	27110640-097	29,44	1
	27110640-098	20,18	1
	N 27110640-190	20,18	1

 Marco estética mínima vertical 2 elementos: 1 clean schuko y 1 módulo estrecho	27192620-090	4,94	5
	27192620-091	18,25	1
	27192620-093	7,89	1
	27192620-094	18,25	1
	27192620-095	18,25	1
	27192620-096	18,25	1
	27192620-097	18,25	1
	27192620-098	7,89	5
	N 27192620-190	7,89	5

 Marco estética mínima vertical 3 elementos: 1 clean schuko y 2 módulos estrechos	27192630-090	7,60	5
	27192630-091	28,06	1
	27192630-093	12,16	1
	27192630-094	28,06	1
	27192630-095	28,06	1
	27192630-096	28,06	1
	27192630-097	28,06	1
	27192630-098	12,16	1
	N 27192630-190	12,16	1

BASTIDORES

 Bastidor 1 Elemento	20000910-039	0,90	20
Bastidor 2 Elementos	20000920-039	1,60	10
Bastidor 3 Elementos	20000930-039	2,39	5
Bastidor 4 Elementos	20000940-039	3,18	5
Bastidor 5 Elementos	20000950-039	4,73	5

CAJAS DE SUPERFICIE

 Caja de Superficie 1 elemento	20000751-090	5,84	10
	20000751-098	7,57	10
	N 20000751-190	7,57	10
 Caja de Superficie 2 elementos	20000752-090	10,46	5
	20000752-098	13,60	5
	N 20000752-190	13,60	5
 Caja de Superficie 3 elementos	20000753-090	13,65	5
	20000753-098	17,74	5
	N 20000753-190	17,74	5

DESCRIPCIÓN

ARTÍCULO PRECIO € PIEZAS CAJA
Recomendado

CAJAS DE SUPERFICIE COMPACTA

	Caja de Superficie Compacta con marco 1 elemento	20000811-090	6,09	10
		20000811-098	7,93	10
		N 20000811-190	7,93	10
	Caja de Superficie Compacta con marco 2 elementos	20000821-090	10,82	5
		20000821-098	14,05	5
		N 20000821-190	14,05	5
	Caja de Superficie Compacta con marco 3 elementos	20000831-090	14,10	5
		20000831-098	18,33	5
		N 20000831-190	18,33	5

MECANISMOS

MECANISMOS DE MANDO

	Interruptor pulsante	20000101-090	4,73	10
		20000101-091	9,75	5
		20000101-093	7,66	5
		20000101-094	9,75	5
		20000101-095	9,75	5
		20000101-096	9,75	5
		20000101-097	9,75	5
		20000101-098	6,85	10
	N 20000101-190	6,85	20	
	Conmutador pulsante	20000201-090	5,49	10
		20000201-091	11,36	5
		20000201-093	8,93	5
		20000201-094	11,36	5
		20000201-095	11,36	5
		20000201-096	11,36	5
		20000201-097	11,36	5
		20000201-098	8,13	10
	N 20000201-190	8,13	20	
	Cruzamiento pulsante	20000251-090	13,39	10
		20000251-091	25,72	5
		20000251-093	20,20	5
		20000251-094	25,72	5
		20000251-095	25,72	5
		20000251-096	25,72	5
		20000251-097	25,72	5
		20000251-098	19,13	10
	N 20000251-190	19,13	20	
	Pulsador neutro	20000150-090	6,66	10
		20000150-091	12,78	5
		20000150-093	10,04	5
		20000150-094	12,78	5
		20000150-095	12,78	5
		20000150-096	12,78	5
		20000150-097	12,78	5
		20000150-098	9,13	10
		N 20000150-190	9,13	20
	Pulsador con grabado luz	20000151-090	6,86	10
		20000151-091	13,19	5
		20000151-093	10,39	5
		20000151-094	13,19	5
		20000151-095	13,19	5
		20000151-096	13,19	5
		20000151-097	13,19	5
		20000151-098	9,42	10
		N 20000151-190	9,42	20

DESCRIPCIÓN

ARTÍCULO PRECIO € PIEZAS CAJA
Recomendado

	Pulsador con grabado campana	20000152-090	6,86	10
		20000152-091	13,19	5
		20000152-093	10,39	5
		20000152-094	13,19	5
		20000152-095	13,19	5
		20000152-096	13,19	5
	20000152-097	13,19	5	
	20000152-098	9,42	10	
	N 20000152-190	9,42	20	
	Conmutador luminoso	20000204-090	13,79	10
		20000204-091	27,45	5
		20000204-093	21,59	5
		20000204-094	27,45	5
		20000204-095	27,45	5
		20000204-096	27,45	5
		20000204-097	27,45	5
		20000204-098	19,61	10
	N 20000204-190	19,61	20	
	Cruzamiento luminoso	20000254-090	22,40	5
		20000254-098	31,68	5
		N 20000254-190	31,68	10
	Pulsador neutro luminoso	20000160-090	14,35	5
		20000160-098	20,41	5
		N 20000160-190	20,41	10
	Pulsador grabado luz luminoso	20000161-090	13,91	5
		20000161-098	19,80	5
		N 20000161-190	19,80	10
	Interruptor piloto 16 AX	20000102-090*	13,36	5
		20000102-098	19,03	5
		N 20000102-190	19,03	10
	Interruptor bipolar piloto	20000134-090*	28,60	5
		20000134-098	40,71	5
		N 20000134-190	40,71	10
	Interruptor Pulsante 16 AX	20000111-090*	11,17	5
		20000111-098	15,89	5
		N 20000111-190	15,89	10

MECANISMOS DE MANDO MÓDULO ESTRECHO

	Interruptor pulsante módulo estrecho	20001101-090	4,93	20
		20001101-091	12,02	10
		20001101-093	8,85	10
		20001101-094	12,02	10
		20001101-095	12,02	10
		20001101-096	12,02	10
		20001101-097	12,02	10
		20001101-098	7,43	20
		N 20001101-190	7,43	20
	Conmutador pulsante módulo estrecho	20001201-090	5,66	20
		20001201-091	14,02	10
		20001201-093	9,84	10
		20001201-094	14,02	10
		20001201-095	14,02	10
		20001201-096	14,02	10
		20001201-097	14,02	10
		20001201-098	8,81	20
		N 20001201-190	8,81	20
	Cruzamiento pulsante módulo estrecho	20001251-090	15,84	20
		20001251-091	28,67	10
		20001251-093	22,53	10
		20001251-094	28,67	10
		20001251-095	28,67	10
		20001251-096	28,67	10
		20001251-097	28,67	10
		20001251-098	20,49	20
		N 20001251-190	20,49	20

COLECCIONES DE MECANISMOS

SERIES SUPERFICIE Y EMPOTRAR

DESCRIPCIÓN	ARTÍCULO	PRECIO € <small>Recomendado</small>	PIEZAS CAJA
	Pulsador neutro módulo estrecho	20001150-090	8,52 20
		20001150-091	15,75 10
		20001150-093	12,36 10
		20001150-094	15,75 10
		20001150-095	15,75 10
		20001150-096	15,75 10
		20001150-097	15,75 10
		20001150-098	11,26 20
	N 20001150-190	11,26 20	
	Kit Monoblock conmutador 10AX IP44	20000951-090	13,76 1
	Kit Complete conmutador 10AX IP44	N 20000951-190	19,41 1
	Kit Monoblock pulsador 10AX IP44	20000952-090	13,76 1
	Kit Complete pulsador 10A IP44	N 20000952-190	19,41 1
	Pulsador con grabado luz módulo estrecho	20001151-090	8,81 20
		20001151-091	16,24 10
		20001151-093	12,77 10
		20001151-094	16,24 10
		20001151-095	16,24 10
		20001151-096	16,24 10
		20001151-097	16,24 10
		20001151-098	11,61 20
		N 20001151-190	11,61 20
		Pulsador con grabado campana módulo estrecho	20001152-090
		20001152-091	16,24 10
		20001152-093	12,77 10
		20001152-094	16,24 10
		20001152-095	16,24 10
		20001152-096	16,24 10
		20001152-097	16,24 10
		20001152-098	11,61 20
	N 20001152-190	11,61 20	
	Conmutador luminoso módulo estrecho	20001204-090	15,39 20
		20001204-091	30,63 10
		20001204-093	24,07 10
		20001204-094	30,63 10
		20001204-095	30,63 10
		20001204-096	30,63 10
		20001204-097	30,63 10
		20001204-098	21,88 20
	N 20001204-190	21,88 20	
	Cruzamiento luminoso módulo estrecho	20001254-090	24,96 10
		20001254-098	35,29 10
		N 20001254-190	35,29 10
	Pulsador neutro luminoso módulo estrecho	20001160-090	16,03 10
		20001160-098	22,75 10
		N 20001160-190	22,75 10
	Pulsador grabado luz luminoso módulo estrecho	20001161-090	15,53 10
		20001161-098	22,06 10
		N 20001161-190	22,06 10
	Interruptor piloto 16 AX	20001102-090	13,93 10
		20001102-098	19,81 10
		N 20001102-190	19,81 10
	Interruptor bipolar piloto módulo estrecho	20001134-090	35,14 10
		20001134-098	50,02 10
		N 20001134-190	50,02 10
	Interruptor bipolar basculante 16 AX estrecho	20001111-090	11,50 10
		20001111-098	16,38 10

DESCRIPCIÓN	ARTÍCULO	PRECIO € <small>Recomendado</small>	PIEZAS CAJA
MECANISMOS ESPECIALES			
	Tarjetero 1 microrruptor	20000526-090	29,99 5
		20000526-091	54,99 1
		20000526-093	46,52 1
		20000526-094	54,99 1
		20000526-095	54,99 1
		20000526-096	54,99 1
		20000526-097	54,99 1
		20000526-098	42,30 5
		N 20000526-190	42,30 5
		Tarjetero 2 microrruptores	20000550-090
		20000550-091	58,29 1
		20000550-093	49,31 1
		20000550-094	58,29 1
		20000550-095	58,29 1
		20000550-096	58,29 1
		20000550-097	58,29 1
		20000550-098	44,84 5
		N 20000550-190	44,84 5
		Pulsador de Tirador	20000153-090
		20000153-098	22,28 10
		N 20000153-190	22,28 10

TOMAS DE CORRIENTE

BASES DE ENCHUFE

	Base de enchufe clean schuko	20000434-090	8,20 10
		20000434-091	19,18 10
		20000434-093	13,17 10
		20000434-094	19,18 10
		20000434-095	19,18 10
		20000434-096	19,18 10
		20000434-097	19,18 10
		20000434-098	12,61 10
	N 20000434-190	12,61 10	
	Base de enchufe euroamericana	N 20000439-090	12,71 10
		N 20000439-098	15,26 10
	Base de enchufe schuko embornamiento tornillo	20000432-090	5,90 10
		20000432-091	12,34 10
		20000432-093	8,89 10
		20000432-094	12,34 10
		20000432-095	12,34 10
		20000432-096	12,71 10
		20000432-097	12,34 10
		20000432-098	8,48 10
		N 20000432-190	8,48 10
		Base de enchufe schuko embornamiento rápido	20000472-090
		20000472-098	8,48 10
		N 20000472-190	8,48 10
	Kit Base Schuko emb Tornillo IP44	N 20000950-090	13,49 10
	Base de enchufe Schuko emb Tornillo IP44	N 20000492-090	9,64 10
		N 20000492-190	10,60 10
		N 20000492-098	10,60 10
		N 20000492-093	11,57 10
		N 20000492-094	13,49 10
		N 20000492-095	13,49 10
		N 20000492-091	13,49 10
		N 20000492-096	11,57 10
		N 20000492-097	13,49 10

DESCRIPCIÓN

ARTÍCULO PRECIO € PIEZAS
Recomendado CAJA

DESCRIPCIÓN

ARTÍCULO PRECIO € PIEZAS
Recomendado CAJA

	Base de enchufe Bipolar	20000431-090	6,25	10
		20000431-098	9,05	10
		N 20000431-190	9,05	10

	Cargador USB 1 boca C	N 20000382-090	48,84	1
		N 20000382-091	71,22	1
		N 20000382-093	60,27	1
		N 20000382-094	71,22	1
		N 20000382-095	71,22	1
		N 20000382-096	71,22	1
		N 20000382-097	71,22	1
		N 20000382-098	54,79	1
		N 20001432-090	61,05	1
		N 20001432-091	74,11	1

BASES DE ENCHUFE FRANCESA

	Base de enchufe clean Francesa	20000455-090	9,21	10
		20000455-091	21,53	10
		20000455-098	14,16	10
		20000455-093	14,79	10
		20000455-094	21,53	10
		20000455-095	21,53	10
		20000455-096	21,53	10
		20000455-097	21,53	10

	Base schuko con cargador USB C	N 20001432-090	61,05	1
		N 20001432-091	74,11	1
		N 20001432-093	66,25	1
		N 20001432-094	74,11	1
		N 20001432-095	74,11	1
		N 20001432-096	74,11	1
		N 20001432-097	74,11	1
		N 20001432-098	63,47	1
		N 20001432-190	63,47	1

	Base de enchufe Francesa	20000458-090	6,46	10
		20000458-098	9,28	10
		20000458-093	9,73	10
		N 20000458-190	9,28	10

SOLUCIONES DE CARGA USB

	Kit Monoblock enchufe + Cargador USB doble A+A 2,1A	E 27190610-090	56,28	1
		E 27190610-091	68,31	1
		E 27190610-093	61,07	1
		E 27190610-094	68,31	1
		E 27190610-095	68,31	1
		E 27190610-096	68,31	1
		E 27190610-097	68,31	1
		E 27190610-098	58,51	1

MULTIMEDIA

TOMAS TV

	KIT Monoblock Conmutador pulsante mínimo + Cargador USB A 2,1A SmartCharge	E 27191610-090	59,41	1
		E 27191610-091	70,33	1
		E 27191610-093	61,85	1
		E 27191610-094	70,33	1
		E 27191610-095	70,33	1
		E 27191610-096	70,33	1
		E 27191610-097	70,33	1
		E 27191610-098	61,85	1

	Toma R-TV+Sat Unica	20000486-090	22,13	10
		20000486-091	35,52	5
		20000486-093	27,93	5
		20000486-094	35,52	5
		20000486-095	35,52	5
		20000486-096	35,52	5
		20000486-097	35,52	5
		20000486-098	25,38	10
		N 20000486-190	25,38	10

	Cargador USB doble A+A 3,1A Smartcharge	20000196-090	55,88	1
		20000196-091	77,92	1
		20000196-093	65,93	1
		20000196-094	77,92	1
		20000196-095	77,92	1
		20000196-096	77,92	1
		20000196-097	77,92	1
		20000196-098	59,94	1
		N 20000196-190	59,94	1

	Toma R-TV+Sat Intermedia	20000487-090	21,77	10
		20000487-091	34,95	5
		20000487-093	27,45	5
		20000487-094	34,95	5
		20000487-095	34,95	5
		20000487-096	34,95	5
		20000487-097	34,95	5
		20000487-098	24,97	10
		N 20000487-190	24,97	10

	Cargador USB doble A+A 2,1A	E 20000096-090	51,22	1
		E 20000096-091	74,70	1
		E 20000096-093	63,22	1
		E 20000096-094	74,70	1
		E 20000096-095	74,70	1
		E 20000096-096	74,70	1
		E 20000096-097	74,70	1
		E 20000096-098	57,47	1

	Toma R-TV+Sat Final	20000488-090	21,96	10
		20000488-091	35,24	5
		20000488-093	27,70	5
		20000488-094	35,24	5
		20000488-095	35,24	5
		20000488-096	35,24	5
		20000488-097	35,24	5
		20000488-098	25,19	10
		N 20000488-190	25,19	10

	Cargador USB doble C+A 3,1A Quickcharge	N 20000296-090	55,88	1
		N 20000296-091	77,92	1
		N 20000296-093	65,93	1
		N 20000296-094	77,92	1
		N 20000296-095	77,92	1
		N 20000296-096	77,92	1
		N 20000296-097	77,92	1
		N 20000296-098	59,94	1

	Tapa para Toma R-TV+Sat	20000053-090	4,71	5
		20000053-098	5,37	5
		N 20000053-190	5,37	5







VOZ Y DATOS

	Tapa RJ45 sin conector	20000087-090	7,79	10
		20000087-093	9,77	10
		20000087-098	8,89	10
		N 20000087-190	8,89	10

	Tapa RJ45 doble sin conector	20000088-090	7,96	10
		20000088-093	11,44	10
		20000088-098	10,41	10
		N 20000088-190	10,41	10

COLECCIONES DE MECANISMOS

SERIES SUPERFICIE Y EMPOTRAR

DESCRIPCIÓN	ARTÍCULO	PRECIO € <small>Recomendado</small>	PIEZAS CAJA
 Toma RJ45 con conector	20000187-090	20,79	10
	20000187-091	30,84	5
	20000187-093	24,24	5
	20000187-094	30,84	5
	20000187-095	30,84	5
	20000187-096	30,84	5
	20000187-097	30,84	5
	20000187-098	22,03	10
 Toma RJ45 doble con conector	N 20000187-190	22,03	10
	20000188-090	34,31	10
	20000188-091	50,85	5
	20000188-093	39,98	5
	20000188-094	50,85	5
	20000188-095	50,85	5
	20000188-096	50,85	5
	20000188-097	50,85	5
	20000188-098	36,34	10
	N 20000188-190	36,34	10
 Toma fibra óptica doble	20000546-090	22,66	5
	20000546-098	25,46	5
	N 20000546-190	25,46	1
 Conector HDMI 2.0 4K H-H	20000094-090	70,35	1
	20000094-091	83,24	1
	20000094-093	79,27	1
	20000094-094	83,24	1
	20000094-095	83,24	1
	20000094-096	83,24	1
	20000094-097	83,24	1
	20000094-098	75,49	1
	N 20000094-190	75,49	1
	 Conector HDMI 2.0 4K + USB Tipo A	20000095-090	97,71
20000095-091		115,60	1
20000095-093		110,09	1
20000095-094		115,60	1
20000095-095		115,60	1
20000095-096		115,60	1
20000095-097		115,60	1
20000095-098		104,85	1
N 20000095-190		104,85	1
 Conector USB datos tipo A	20000090-090	23,49	1
	20000090-091	36,96	1
	20000090-093	29,04	1
	20000090-094	36,96	1
	20000090-095	36,96	1
	20000090-096	36,96	1
	20000090-097	36,96	1
	20000090-098	26,40	1
N 20000090-190	26,40	1	
 Conector VGA + minijack	20000091-090	41,07	1
	20000091-098	46,10	1
	N 20000091-190	46,10	1

DESCRIPCIÓN	ARTÍCULO	PRECIO € <small>Recomendado</small>	PIEZAS CAJA
FUNCIONES			
CONTROL DE LUZ			
 Regulador rotativo CF 2H	20000313-090	73,29	1
	20000313-091	83,18	1
	20000313-093	76,65	1
	20000313-094	83,18	1
	20000313-095	83,18	1
	20000313-096	83,18	1
	20000313-097	83,18	1
	20000313-098	74,34	1
	N 20000313-190	74,34	1
	CONFORT		
 Int. de persianas 3 pos. módulo estrecho	20001333-090	26,12	10
	20001333-091	39,47	5
	20001333-093	30,99	5
	20001333-094	39,47	5
	20001333-095	39,47	5
	20001333-096	39,47	5
	20001333-097	39,47	5
	20001333-098	28,19	10
	N 20001333-190	28,19	10
	 Int. de persianas 3 pos	20000333-090	25,87
20000333-091		39,47	5
20000333-093		30,99	5
20000333-094		39,47w	5
20000333-095		39,47	5
20000333-096		39,47	5
20000333-097		39,47	5
20000333-098		28,19	5
N 20000333-190		28,19	5
VARIOS			
SALIDA DE CABLES			
 Salida cables	20000801-090	6,38	10
	20000801-098	8,10	10
	N 20000801-190	8,10	10
TAPA CIEGA			
 Tapa ciega módulo estrecho	20001800-090	2,49	20
	20001800-091	6,85	5
	20001800-093	5,38	5
	20001800-094	6,85	5
	20001800-095	6,85	5
	20001800-096	6,85	5
	20001800-097	6,85	5
	20001800-098	4,80	20
	N 20001800-190	4,80	20
	 Tapa ciega	20000800-090	3,14
20000800-091		6,65	5
20000800-093		5,22	5
20000800-094		6,65	5
20000800-095		6,65	5
20000800-096		6,65	5
20000800-097		6,65	5
20000800-098		4,83	10
N 20000800-190		4,83	10

DESCRIPCIÓN

ARTÍCULO PRECIO € PIEZAS
Recomendado CAJA

TIMBRE PULSADOR

	Timbre (zumbador)	20000806-090	25,29	10
		20000806-098	28,17	10
		N 20000806-190	28,17	10



MECANISMOS iO

	Conmutador electrónico iO tecla estrecha	21001201-090	87,92	1
		21001201-091	103,61	1
		21001201-093	92,65	1
		21001201-094	103,61	1
		21001201-095	103,61	1
		21001201-096	103,61	1
		21001201-097	103,61	1
		21001201-098	88,74	1
		N 21001201-190	88,74	1
	Master Conmutador iO tecla estrecha	21011036-090	80,81	1
		21011036-091	95,24	1
		21011036-093	85,17	1
		21011036-094	95,24	1
		21011036-095	95,24	1
		21011036-096	95,24	1
		21011036-097	95,24	1
		21011036-098	81,56	1
		N 21011036-190	81,56	1
	Conmutador electrónico iO	21000201-090	87,92	1
		21000201-091	103,61	1
		21000201-093	92,65	1
		21000201-094	103,61	1
		21000201-095	103,61	1
		21000201-096	103,61	1
		21000201-097	103,61	1
		21000201-098	88,74	1
		N 21000201-190	88,74	1
	Master Conmutador iO	21010036-090	80,81	1
		21010036-091	95,24	1
		21010036-093	85,17	1
		21010036-094	95,24	1
		21010036-095	95,24	1
		21010036-096	95,24	1
		21010036-097	95,24	1
		21010036-098	81,56	1
		N 21010036-190	81,56	1

DESCRIPCIÓN

ARTÍCULO PRECIO € PIEZAS
Recomendado CAJA

TOMAS DE CORRIENTE iO





	Base de enchufe schuko iO	21000432-090	80,81	1
		21000432-091	95,24	1
		21000432-093	85,17	1
		21000432-094	95,24	1
		21000432-095	95,24	1
		21000432-096	95,24	1
		21000432-097	95,24	1
		21000432-098	81,56	1
		N 21000432-190	81,56	1

FUNCIONES iO





CONTROL DE LUZ







	Interruptor regulable PWM Tira de LED iO tecla estrecha	21001314-090	111,60	1
		21001314-091	135,48	1
		21001314-093	117,61	1
		21001314-094	131,53	1
		21001314-095	131,53	1
		21001314-096	131,53	1
		21001314-097	131,53	1
		21001314-098	112,63	1
		N 21001314-190	112,63	1
	Interruptor regulable DALI iO tecla estrecha	21001316-090	153,02	1
		21001316-091	180,37	1
		21001316-093	161,27	1
		21001316-094	180,37	1
		21001316-095	180,37	1
		21001316-096	180,37	1
		21001316-097	180,37	1
		21001316-098	154,47	1
		N 21001316-190	154,47	1
	Interruptor regulable 1-10V iO tecla estrecha	21001317-090	136,45	1
		21001317-091	160,84	1
		21001317-093	143,80	1
		21001317-094	160,84	1
		21001317-095	160,84	1
		21001317-096	160,84	1
		21001317-097	160,84	1
		21001317-098	137,74	1
		N 21001317-190	137,74	1
	Interruptor regulable CF 3H iO tecla estrecha	21001321-090	93,83	1
		21001321-091	110,60	1
		21001321-093	98,90	1
		21001321-094	110,60	1
		21001321-095	110,60	1
		21001321-096	110,60	1
		21001321-097	110,60	1
		21001321-098	94,71	1
		N 21001321-190	94,71	1
	Master interruptor regulable iO tecla estrecha	21001121-090	91,46	1
		21001121-091	107,81	1
		21001121-093	96,40	1
		21001121-094	107,81	1
		21001121-095	107,81	1
		21001121-096	107,81	1
		21001121-097	107,81	1
		21001121-098	92,32	1
		N 21001121-190	92,32	1
	Interruptor regulable PWM Tira de LED iO	21000314-090	111,60	1
		21000314-091	131,53	1
		21000314-093	117,61	1
		21000314-094	131,53	1
		21000314-095	131,53	1
		21000314-096	131,53	1
		21000314-097	131,53	1
		21000314-098	112,63	1
		N 21000314-190	112,63	1

COLECCIONES DE MECANISMOS

DESCRIPCIÓN	ARTÍCULO	PRECIO € <small>Recomendado</small>	PIEZAS CAJA
 Interruptor regulable DALI iO	21000316-090	153,02	1
	21000316-091	180,37	1
	21000316-093	161,27	1
	21000316-094	180,37	1
	21000316-095	180,37	1
	21000316-096	180,37	1
	21000316-097	180,37	1
	21000316-098	154,47	1
	N 21000316-190	154,47	1
 Interruptor regulable 1-10V iO	21000317-090	136,45	1
	21000317-091	160,84	1
	21000317-093	143,80	1
	21000317-094	160,84	1
	21000317-095	160,84	1
	21000317-096	160,84	1
	21000317-097	160,84	1
	21000317-098	137,74	1
	N 21000317-190	137,74	1
 Interruptor regulable CF 3H iO	21000321-090	93,83	1
	21000321-091	110,60	1
	21000321-093	98,90	1
	21000321-094	110,60	1
	21000321-095	110,60	1
	21000321-096	110,60	1
	21000321-097	110,60	1
	21000321-098	94,71	1
	N 21000321-190	94,71	1
 Master interruptor regulable iO	21000121-090	91,46	1
	21000121-091	107,81	1
	21000121-093	96,40	1
	21000121-094	107,81	1
	21000121-095	107,81	1
	21000121-096	107,81	1
	21000121-097	107,81	1
	21000121-098	92,32	1
	N 21000121-190	92,32	1

CONFORT

 Interruptor de Persianas iO tecla estrecha	21001333-090	95,91	1
	21001333-091	113,05	1
	21001333-093	101,08	1
	21001333-094	113,05	1
	21001333-095	113,05	1
	21001333-096	113,05	1
	21001333-097	113,05	1
	21001333-098	96,79	1
	N 21001333-190	96,79	1
 Master Persianas iO tecla estrecha	21001133-090	87,92	1
	21001133-091	103,61	1
	21001133-093	92,65	1
	21001133-094	103,61	1
	21001133-095	103,61	1
	21001133-096	103,61	1
	21001133-097	103,61	1
	21001133-098	88,72	1
	N 21001133-190	88,72	1
 Interruptor persianas lamas iO estrecho	21001359-090	148,10	1
	21001359-093	154,05	1
	21001359-096	159,19	1
	21001359-098	148,92	1
	N 21001359-190	148,92	1
 Master persianas lamas iO estrecho	21001233-090	86,74	1
	21001233-093	91,35	1
	21001233-096	102,13	1
	21001233-098	87,50	1
	N 21001233-190	87,50	1

DESCRIPCIÓN	ARTÍCULO	PRECIO € <small>Recomendado</small>	PIEZAS CAJA
 Int. de Persianas iO	21000333-090	95,91	1
	21000333-091	113,05	1
	21000333-093	101,08	1
	21000333-094	113,05	1
	21000333-095	113,05	1
	21000333-096	113,05	1
	21000333-097	113,05	1
	21000333-098	96,79	1
	N 21000333-190	96,79	1
 Master Persianas iO	21000133-090	87,92	1
	21000133-091	103,61	1
	21000133-093	92,65	1
	21000133-094	103,61	1
	21000133-095	103,61	1
	21000133-096	103,61	1
	21000133-097	103,61	1
	21000133-098	88,72	1
	N 21000133-190	88,72	1
 Interruptor persianas lamas iO	21000359-090	148,10	1
	21000359-093	154,05	1
	21000359-096	159,19	1
	21000359-098	148,92	1
	N 21000359-190	148,92	1
 Master persianas lamas iO	21000233-090	86,74	1
	21000233-093	91,35	1
	21000233-096	102,13	1
	21000233-098	87,50	1
 Master 2 experiencias iO	N 21000233-190	87,50	1
	21021035-090	90,28	1
	21021035-091	106,41	1
	21021035-093	95,15	1
	21021035-094	106,41	1
	21021035-095	106,41	1
	21021035-096	106,41	1
	21021035-097	106,41	1
	21021035-098	91,15	1
N 21021035-190	91,15	1	
 Master 4 experiencias iO	21040035-090	98,58	1
	21040035-091	116,17	1
	21040035-093	103,88	1
	21040035-094	116,17	1
	21040035-095	116,17	1
	21040035-096	116,17	1
	21040035-097	116,17	1
	21040035-098	99,50	1
	N 21040035-190	99,50	1
 Multimaster Keypad 6 experiencias	21060035-090	137,52	1
	21060035-091	170,01	1
	21060035-093	147,20	1
	21060035-094	170,01	1
	21060035-095	170,01	1
	21060035-096	154,55	1
	21060035-097	170,01	1
	21060035-098	140,19	1
	N 21060035-190	140,19	1

TERMOSTATOS iO

 Termostato calefacción iO	21000811-090	185,16	1
	21000811-091	204,51	1
	21000811-098	194,69	1
	21000811-093	199,17	1
	21000811-094	204,51	1
	21000811-095	204,51	1
	21000811-096	204,51	1
	21000811-097	204,51	1
	N 21000811-190	194,69	1

DESCRIPCIÓN

ARTÍCULO PRECIO €
Recomendado PIEZAS
CAJA

DESCRIPCIÓN

ARTÍCULO PRECIO €
Recomendado PIEZAS
CAJA

	Termostato suelo radiante electrico iO	21000812-090	192,13	1
		21000812-091	206,04	1
		21000812-098	196,14	1
		21000812-093	200,66	1
		21000812-094	206,04	1
		21000812-095	206,04	1
		21000812-096	206,04	1
		21000812-097	206,04	1
		N 21000812-190	196,14	1

COMPLEMENTOS iO

	HUB PRO iO Desktop	21032108-039	332,16	1
	Interruptor (DIN) Apagado Total Iluminación iO	10002890-039	295,30	1
	Micromódulo interruptor iO para Electroválvula	10002892-039	65,60	1
	Sensor de humo iO	10002862-039	109,20	1
	Sensor de agua iO	10002860-039	87,40	1
	Sensor de Apertura/Cierre iO	10002214-039	65,60	1
	Sensor de Movimiento iO	10002343-039	81,90	1
	Sensor de Gas iO	10002861-039	98,30	1
	Repetidor Z-wave con enchufe iO	10002880-039	65,60	1

COLECCIONES DE MECANISMOS

SERIES SUPERFICIE Y EMPOTRAR



Simon | 100

MARCOS ESTÉTICA MÍNIMA

BRILLANTE

DESCRIPCIÓN	ARTÍCULO	PRECIO € Recomendado	PIEZAS CAJA
1 elemento	10001610-130	13,09	1
2 elementos	10001620-130	19,87	1
3 elementos	10001630-130	27,87	1
4 elementos	10001640-130	34,00	1
1 elemento	10001610-138	13,09	1
2 elementos	10001620-138	19,87	1
3 elementos	10001630-138	27,87	1
4 elementos	10001640-138	34,00	1

MATE

1 elemento	10001610-230	13,66	1
2 elementos	10001620-230	20,71	1
3 elementos	10001630-230	27,80	1
4 elementos	10001640-230	34,52	1
1 elemento	10001610-238	13,66	1
2 elementos	10001620-238	20,71	1
3 elementos	10001630-238	27,80	1
4 elementos	10001640-238	34,52	1

MARCOS VERTICALES

BRILLANTE

2 elementos 2 módulos	10002620-130	19,87	1
2 elementos 3 módulos	10002621-130	15,67	1
2 elementos 2 módulos	10002620-138	19,87	1
2 elementos 3 módulos	10002621-138	15,67	1

MATE

2 elementos 2 módulos	10002620-230	20,71	1
2 elementos 3 módulos	10002621-230	16,27	1
2 elementos 2 módulos	10002620-238	20,71	1
2 elementos 3 módulos	10002621-238	16,27	1

MARCOS

BRILLANTE

1 elemento	10000610-130	10,63	1
2 elementos	10000620-130	14,78	1
3 elementos	10000630-130	19,31	1
4 elementos	10000640-130	23,45	1

DESCRIPCIÓN	ARTÍCULO	PRECIO € Recomendado	PIEZAS CAJA
1 elemento	10000610-138	10,63	1
2 elementos	10000620-138	14,78	1
3 elementos	10000630-138	19,31	1
4 elementos	10000640-138	23,45	1

MATE

1 elemento	10000610-230	11,09	1
2 elementos	10000620-230	15,42	1
3 elementos	10000630-230	19,44	1
4 elementos	10000640-230	22,95	1
1 elemento	10000610-238	11,09	1
2 elementos	10000620-238	15,42	1
3 elementos	10000630-238	19,44	1
4 elementos	10000640-238	22,95	1









BASTIDORES

Bastidor 1 elemento	10000910-039	2,26	5
Bastidor 2 elementos	10000920-039	2,99	5
Bastidor 3 elementos	10000930-039	3,97	5
Bastidor 4 elementos	10000940-039	5,58	1
Bastidor 1 elem con adhesivo para Máster iO Baterías	10001910-039	4,61	5
Bastidor 2 elem con adhesivo para Máster iO Baterías	10001920-039	5,72	5





KITS







1 ELEMENTO

Kit front 1 elemento 1 tecla	10020101-130	23,85	1
Kit front 1 elemento 1 tecla	10020101-138	23,85	1
Kit front 1 elemento 1 tecla	10020101-230	25,11	1
Kit front 1 elemento 1 tecla	10020101-238	25,11	1
Kit back 1 elemento 1 conmutador	10010101-039	11,17	1
Kit back 1 elemento 1 cruzamiento	10010102-039	20,05	1
Kit front 1 elemento 2 teclas	10020103-130	32,16	1
Kit front 1 elemento 2 teclas	10020103-138	32,16	1
Kit front 1 elemento 2 teclas	10020103-230	33,99	1
Kit front 1 elemento 2 teclas	10020103-238	33,99	1
Kit back 1 elemento 2 conmutadores	10010103-039	20,11	1
Kit back 1 elemento 2 cruzamientos	10010104-039	37,86	1
Kit front 1 elemento 1 base enchufe	10020105-130	25,72	1
Kit front 1 elemento 1 base enchufe	10020105-138	25,72	1
Kit front 1 elemento 1 base enchufe	10020105-230	27,14	1
Kit front 1 elemento 1 base enchufe	10020105-238	27,14	1
Kit back 1 elemento 1 base enchufe	10010105-039	10,78	1
Kit front 1 elemento 1 toma RJ45	10020106-130	24,71	1
Kit front 1 elemento 1 toma RJ45	10020106-138	24,71	1
Kit front 1 elemento 1 toma RJ45	10020106-230	26,00	1
Kit front 1 elemento 1 toma RJ45	10020106-238	26,00	1
Kit 1 elemento 1 toma RJ45 cat 6	10010106-039	25,62	1
Kit front 1 elemento base con cargador USB	€ 10020109-130	31,24	1
Kit front 1 elemento base con cargador USB	€ 10020109-138	31,24	1
Kit front 1 elemento base con cargador USB	€ 10020109-230	33,00	1
Kit front 1 elemento base con cargador USB	€ 10020109-238	33,00	1

DESCRIPCIÓN	ARTÍCULO	PRECIO € Recomendado	PIEZAS CAJA
 Kit 1 elemento base con cargador USB 2.1A smartcharge E	10010109-039	68,80	1
	10020111-130	25,43	1
	10020111-138	25,43	1
	10020111-230	26,83	1
	10020111-238	26,83	1
 Kit back 1 elemento 2 tomas RJ45 cat 6	10010111-039	43,82	1
	10020113-130	58,73	1
	10020113-138	58,73	1
	10020113-230	63,63	1
	10020113-238	63,63	1
 Kit back 1 elemento interruptor regulable corte fase 2/3 hilos	10010113-039	93,49	1
	10020115-130	68,29	1
	10020115-138	68,29	1
	10020115-230	74,65	1
	10020115-238	74,65	1
 Kit back persianas	10010115-039	86,40	1
	N 10020137-130	30,36	1
	N 10020137-138	30,36	1
	N 10020137-230	32,07	1
	N 10020137-238	32,07	1
 Kit 1 elemento base con cargador USB C N	10010137-039	72,71	1













































2 ELEMENTOS

	10020201-130	41,40	1
	10020201-138	41,40	1
	10020201-230	43,61	1
	10020201-238	43,61	1
	10010201-039	20,85	1
	10020202-130	44,95	1
	10020202-138	44,95	1
	10020202-230	47,51	1
	10020202-238	47,51	1
	10010202-039	20,06	1
	10020203-130	44,83	1
	10020203-138	44,83	1
	10020203-230	47,39	1
	10020203-238	47,39	1
	10010203-039	20,45	1
	10020204-130	51,39	1
	10020204-138	51,39	1
	10020204-230	54,34	1
	10020204-238	54,34	1

DESCRIPCIÓN	ARTÍCULO	PRECIO € Recomendado	PIEZAS CAJA
 Kit back 2 elementos 1 base + 2 conmutadores	10010204-039	29,38	1
	10020205-130	43,51	1
	10020205-138	43,51	1
	10020205-230	45,99	1
	10020205-238	45,99	1
 Kit back 2 elementos 1 base + 1 cargador 2xUSB 2.1A	10010205-039	57,45	1
	E 10020206-130	56,85	1
	E 10020206-138	56,85	1
	E 10020206-230	60,15	1
	E 10020206-238	60,15	1
 Kit 2 elementos base + conmut + cargUSB 2.1A smartcharge E	10010206-039	62,45	1
	E 10010207-039	72,02	1
	E 10020207-130	56,85	1
	E 10020207-138	56,85	1
	E 10020207-230	60,15	1
	E 10020207-238	60,15	1
	10010206-039	62,45	1
	10010207-039	72,02	1
	10020208-130	45,14	1
	10020208-138	45,14	1
	10020208-230	47,69	1
	10020208-238	47,69	1
	10010208-039	50,68	1
	E 10020209-130	92,94	1
	E 10020209-138	92,94	1
	E 10020209-230	99,99	1
	E 10020209-238	99,99	1
	E 10010209-039	151,43	1
	E 10021209-130	92,94	1
	E 10021209-138	92,94	1
	E 10021209-230	99,99	1
	E 10021209-238	99,99	1
	E 10010209-039	151,43	1
	E 10022010-130	46,31	1
	E 10022010-138	46,31	1
	E 10022010-230	48,92	1
	E 10022010-238	48,92	1
	E 10010210-039	93,12	1
	E 10020211-130	55,60	1
	E 10020211-138	55,60	1
	E 10020211-230	66,30	1
	E 10020211-238	66,30	1
	E 10010211-039	133,27	1

COLECCIONES DE MECANISMOS

SERIES SUPERFICIE Y EMPOTRAR

DESCRIPCIÓN	ARTÍCULO	PRECIO € Recomendado	PIEZAS CAJA
	 10020212-130	58,44	1
	 10020212-138	58,44	1
	 10020212-230	61,83	1
	 10020212-238	61,83	1
	 10010212-039	81,19	1
	10020238-130	41,60	1
	10020238-138	41,60	1
	10020238-230	43,99	1
	10020238-238	53,89	1
	10010238-039	61,16	1
	 10020248-130	54,03	1
	 10020248-138	54,03	1
	 10020248-230	64,42	1
	 10020248-238	64,42	1
	 10010248-039	143,84	1
	 10020249-130	56,79	1
	 10020249-138	56,79	1
	 10020249-230	60,08	1
	 10020249-238	60,08	1
	 10010249-039	93,53	1
	 10020254-130	53,63	1
	 10020254-138	53,63	1
	 10020254-230	56,74	1
	 10020254-238	56,74	1
	 10010254-039	58,91	1
	 10020255-130	53,63	1
	 10020255-138	53,63	1
	 10020255-230	56,74	1
	 10020255-238	56,74	1
	 10010255-039	67,94	1
	 10020256-130	87,67	1
	 10020256-138	87,67	1
	 10020256-230	94,33	1
	 10020256-238	94,33	1
	 10010256-039	142,85	1
	 10020257-130	87,67	1
	 10020257-138	87,67	1
	 10020257-230	94,33	1
	 10020257-238	94,33	1
	 10020258-130	43,68	1
	 10020258-138	43,68	1
	 10020258-230	46,15	1
	 10020258-238	46,15	1
	 10010258-039	87,84	1



DESCRIPCIÓN	ARTÍCULO	PRECIO € Recomendado	PIEZAS CAJA
3 ELEMENTOS			
	10020301-130	60,16	1
	10020301-138	60,16	1
	10020301-230	63,42	1
	10020301-238	63,42	1
	10010301-039	30,77	1
	10020302-130	64,59	1
	10020302-138	64,59	1
	10020302-230	68,32	1
	10020302-238	68,32	1
	10010302-039	29,59	1
	10020303-130	64,76	1
	10020303-138	64,76	1
	10020303-230	68,50	1
	10020303-238	68,50	1
	10010303-039	60,20	1
	10020304-130	63,26	1
	10020304-138	63,26	1
	10020304-230	66,90	1
	10020304-238	66,90	1
	10010304-039	96,19	1
	10020305-130	61,58	1
	10020305-138	61,58	1
	10020305-230	65,12	1
	10020305-238	65,12	1
	10010305-039	101,54	1
	10020306-130	113,01	1
	10020306-138	113,01	1
	10020306-230	122,09	1
	10020306-238	122,09	1
	10010306-039	153,38	1
	10010307-039	162,43	1
	10020308-130	63,14	1
	10020308-138	63,14	1
	10020308-230	66,80	1
	10020308-238	66,80	1
	10010308-039	67,18	1
	 10020309-130	67,11	1
	 10020309-138	67,11	1
	 10020309-230	70,97	1
	 10020309-238	70,97	1
	 10010309-039	103,40	1

DESCRIPCIÓN	ARTÍCULO	PRECIO € Recomendado	PIEZAS CAJA
	10020310-130	71,02	1
	10020310-138	71,02	1
	10020310-230	75,16	1
	10020310-238	75,16	1
	10010310-039	38,91	1
	10020333-130	60,40	1
	10020333-138	60,40	1
	10020333-230	63,88	1
	10020333-238	63,88	1
	10010333-039	151,13	1
	10010334-039	159,62	1
	10020335-130	108,09	1
	10020335-138	108,09	1
	10020335-230	116,77	1
	10020335-238	116,77	1
	10010335-039	70,30	1
	10020336-130	63,31	1
	10020336-138	63,31	1
	10020336-230	66,95	1
	10020336-238	66,95	1
	10010336-039	97,54	1
4 ELEMENTOS			
	10020401-130	83,80	1
	10020401-138	83,80	1
	10020401-230	88,67	1
	10020401-238	88,67	1
	10010401-039	39,70	1
	10020402-130	82,48	1
	10020402-138	82,48	1
	10020402-230	87,26	1
	10020402-238	87,26	1
	10010402-039	106,32	1
	10020403-130	87,19	1
	10020403-138	87,19	1
	10020403-230	92,22	1
	10020403-238	92,22	1
	10010403-039	150,08	1
	10020411-130	82,25	1
	10020411-138	82,25	1
	10020411-230	87,00	1
	10020411-238	87,00	1
	10010411-039	141,58	1

DESCRIPCIÓN	ARTÍCULO	PRECIO € Recomendado	PIEZAS CAJA
KITS VERTICALES			
2 ELEMENTOS			
	10020202-130	44,95	1
	10020202-138	44,95	1
	10020202-230	47,51	1
	10020202-238	47,51	1
	10010202-039	20,06	1
	10020204-130	51,39	1
	10020204-138	51,39	1
	10020204-230	54,34	1
	10020204-238	54,34	1
	10010204-039	29,38	1
	10020213-130	41,40	1
	10020213-138	41,40	1
	10020213-230	43,61	1
	10020213-238	43,61	1
	10010201-039	20,85	1
	10020215-130	51,27	1
	10020215-138	51,27	1
	10020215-230	54,21	1
	10020215-238	54,21	1
	10010214-039	29,78	1
	10020216-130	51,50	1
	10020216-138	51,50	1
	10020216-230	54,45	1
	10020216-238	54,45	1
	10010216-039	52,17	1
	10020218-130	58,44	1
	10020218-138	58,44	1
	10020218-230	61,83	1
	10020218-238	61,83	1
	10010212-039	81,19	1
	10020250-130	50,04	1
	10020250-138	50,04	1
	10020250-230	52,91	1
	10020250-238	52,91	1
3 ELEMENTOS			
	10020302-130	64,59	1
	10020302-138	64,59	1
	10020302-230	68,32	1
	10020302-238	68,32	1
	10010302-039	29,59	1

COLECCIONES DE MECANISMOS

SERIES SUPERFICIE Y EMPOTRAR

DESCRIPCIÓN	ARTÍCULO	PRECIO € Recomendado	PIEZAS CAJA
 Kit front 3 elementos 2 bases + 2 teclas	10020310-130	71,02	1
	10020310-138	71,02	1
	10020310-230	75,16	1
	10020310-238	75,16	1
 Kit 3 elementos 2 bases + 2 conmutadores	10010310-039	38,91	1

DESCRIPCIÓN	ARTÍCULO	PRECIO € Recomendado	PIEZAS CAJA
Tapa conector RJ-45, 2 ventanas	10000006-130	14,82	1
	10000006-138	14,82	1
	10000006-230	15,75	1
	10000006-238	15,75	1
Tapa conector fibra óptica	10000008-130	15,14	1
	10000008-138	15,14	1
	10000008-230	16,48	1
	10000008-238	16,48	1
Tecla int., conmutadores o pulsadores	10000010-130	10,78	1
	10000010-138	10,78	1
	10000010-230	11,46	1
	10000010-238	11,46	1
Tecla int., conmut. o puls. campana	10000017-130	11,70	1
	10000017-138	11,70	1
	10000017-230	12,43	1
	10000017-238	12,43	1
Tapa con aro rojo para base de enchufe schuko	10000037-130	15,72	1
	10000037-138	15,72	1
	10000037-230	16,72	1
	10000037-238	16,72	1
Tapa para base de enchufe bipolar	10000040-130	15,36	1
	10000040-138	15,36	1
	10000040-230	16,35	1
	10000040-238	16,35	1
Tapa para base de enchufe schuko	10000041-130	15,11	1
	10000041-138	15,11	1
	10000041-230	16,05	1
	10000041-238	16,05	1
Tapa mirilla para base schuko	10000042-130	15,84	1
	10000042-138	15,84	1
Tapa para base de enchufe euroamericana	10000047-130	15,36	1
	10000047-138	15,36	1
	10000047-230	16,35	1
	10000047-238	16,35	1
Tapa para base schuko con cargador USB	10000049-130	19,95	1
	10000049-138	19,95	1
	10000049-230	21,26	1
	10000049-238	21,26	1
Tapa para base schuko con cargador USB C	10000050-130	19,95	1
	10000050-138	19,95	1
	10000050-230	21,26	1
	10000050-238	21,26	1
Tapa salida de cables	10000051-130	11,05	1
	10000051-138	11,05	1
	10000051-230	11,76	1
	10000051-238	11,76	1
Tapa toma R-TV + SAT	10000053-130	11,71	1
	10000053-138	11,71	1
	10000053-230	12,45	1
	10000053-238	12,45	1
Tapa para base de enchufe francesa	10000068-130	15,36	1
	10000068-138	15,36	1
	10000068-230	16,35	1
	10000068-238	16,35	1
Tapa toma R-TV + SAT con RJ45	10000072-130	15,29	1
	10000072-138	15,29	1
	10000072-230	16,26	1
	10000072-238	16,26	1
Tapa interruptor tarjeta hotel	10000078-130	15,76	1
	10000078-138	15,76	1
	10000078-230	16,76	1
	10000078-238	16,76	1
Tapa conector VGA + mini-jack	10000091-130	14,18	1
	10000091-138	14,18	1
	10000091-230	15,09	1
	10000091-238	15,09	1
Tecla pulsador electrónico	10000110-130	11,60	1
	10000110-138	11,60	1
	10000110-230	12,34	1
	10000110-238	12,34	1

MECANISMOS			
Adaptador para 1 conector RJ45	10000001-039	10,82	5
Adaptador para 2 conectores RJ45	10000002-039	16,43	5
Interruptor unipolar pulsante	10000101-039	7,62	10
Interruptor bipolar pulsante	10000133-039	15,24	10
Pulsador	10000150-039	7,87	10
Conmutador pulsante	10000201-039	8,97	10
Interruptor-conmutador pulsante 16AX	10000211-039	9,74	10
Cruzamiento pulsante	10000251-039	17,83	10
Cargador USB C+A 3,1A QuickCharge	10000296-039	51,56	1
Cargador USB 2.1A smartcharge	10000380-039	42,69	1
Cargador USB doble 2.1A	10000381-039	51,30	1
Cargador USB 1 boca C	10000382-039	39,52	1
Base de enchufe bipolar	10000431-039	8,91	10
Base de enchufe schuko	10000432-039	8,61	10
Base de enchufe euroamericana	10000439-130	10,27	5
Base de enchufe euroamericana	10000439-138	10,27	5
Base de enchufe francesa	10000458-039	10,27	10
Toma doble CATV	10000465-039	19,05	1
Toma R-TV + SAT - unica	10000466-039	17,29	5
Toma R-TV + SAT - intermedia	10000467-039	17,29	5
Toma R-TV + SAT - final	10000468-039	17,29	5
Toma R-TV + SAT - unica + RJ45 cat 6	10000470-039	39,18	5
Toma R-TV + SAT - intermedia + RJ45 cat 6	10000471-039	39,18	5
Toma R-TV + SAT - final + RJ45 cat 6	10000472-039	39,18	5
Interruptor conmutador tarjeta hotel 1 microrruptor	10000526-039	23,07	5
Conector RJ45 cat 6 con adaptador	10000544-039	23,40	5
Conector fibra óptica dúplex	10000546-230	38,56	1
Conector fibra óptica dúplex	10000546-238	38,56	1
Interruptor conmutador para tarjeta 2 microrruptores	10000550-039	25,37	5
Conector HDMI	10000560-039	32,18	1
Conector USB datos	10000561-039	25,66	1
Conector 2 x USB datos	10000562-039	35,38	1
Conector HDMI + USB datos	10000563-039	44,54	1
Conector VGA + Minij-jack	10000564-039	46,50	1
Conector 3RCA	10000565-039	25,66	1
Conector HDMI v2.0 hembra 2M	10000566-039	97,57	1
Conector HDMI v2.0 + USB 2.0 tipo A 2M	10000567-039	93,35	1
Salida de cables con regleta	10000801-039	10,15	5
Pulsador electrónico	10001150-039	50,58	1
Detector de presencia con lente blanca	10001343-039	118,89	1
Detector de presencia con lente negra	10001344-039	118,89	1
Base schuko con cargador USB int. 2.1A smartcharge	10001432-039	66,10	1
Base francesa con cargador USB int. 2.1A smartcharge	10001458-039	68,07	1
Conector RJ45 cat 6 doble con adaptador	10002544-039	41,60	5
Salida de cables ancha	10002801-039	9,86	5
Base schuko con cargador USB C	10011432-039	70,38	5
Base francesa con cargador USB C	10011458-039	72,48	5

TECLAS Y TAPAS			
Tapa conector RJ-45, 1 ventana	10000005-130	11,63	1
	10000005-138	11,63	1
	10000005-230	12,37	1
	10000005-238	12,37	1

DESCRIPCIÓN	ARTÍCULO	PRECIO € Recomendado	PIEZAS CAJA
Tecla para interruptor bipolar	1000133-130	10,78	1
	1000133-138	10,78	1
	1000133-230	11,46	1
	1000133-238	11,46	1
Tapa con aro rojo base schuko con cargador USB	€ 1000137-130	21,71	1
	€ 1000137-138	21,71	1
	€ 1000137-230	23,10	1
	€ 1000137-238	23,10	1
Tapa para base francesa con cargador USB	€ 1000168-130	19,95	1
	€ 1000168-138	19,95	1
	€ 1000168-230	21,26	1
	€ 1000168-238	21,26	1
Tapa para base francesa con cargador USB C	N 1000169-130	19,95	1
	N 1000169-138	19,95	1
	N 1000169-230	21,26	1
	N 1000169-238	21,26	1
Placa ciega	1000800-130	4,21	1
	1000800-138	4,21	1
	1000800-230	4,48	1
	1000800-238	4,48	1
Tapa ciega doble	10001800-130	8,41	1
	10001800-138	8,41	1
	10001800-230	8,96	1
	10001800-238	8,96	1
Tecla interruptor regulable	10001020-130	45,69	1
	10001020-138	45,69	1
	10001020-230	50,03	1
	10001020-238	50,03	1
Tapa detector de presencia	10001060-130	12,93	1
	10001060-138	12,93	1
	10001060-230	14,43	1
	10001060-238	14,43	1
Tecla persianas	10001080-130	55,02	1
	10001080-138	55,02	1
	10001080-230	60,82	1
	10001080-238	60,82	1
Tapa conector 2 X USB datos	10001090-130	13,59	1
	10001090-138	13,59	1
	10001090-230	14,46	1
	10001090-238	14,46	1
Tapa conector USB datos	10001091-130	11,41	1
	10001091-138	11,41	1
	10001091-230	12,14	1
	10001091-238	12,14	1
Tapa conector 3RCA	10001093-130	11,41	1
	10001093-138	11,41	1
	10001093-230	12,14	1
	10001093-238	12,14	1
Tapa conector HDMI	10001094-130	13,01	1
	10001094-138	13,01	1
	10001094-230	13,83	1
	10001094-238	13,83	1
Tapa conector HDMI+USB datos	10001095-130	13,59	1
	10001095-138	13,59	1
	10001095-230	14,46	1
	10001095-238	14,46	1
Tapa cargador USB 2 bocas	10001096-130	13,66	1
	10001096-138	13,66	1
	10001096-230	14,53	1
	10001096-238	14,53	1
Tapa cargador USB 1 boca	€ 10001097-130	13,80	1
	€ 10001097-138	13,80	1
	€ 10001097-230	14,66	1
	€ 10001097-238	14,66	1
Tapa cargador USB 2 Bocas carga rápida	€ 10001196-130	14,65	1
	€ 10001196-138	14,65	1
	€ 10001196-230	15,58	1
	€ 10001196-238	15,58	1
Tapa cargador USB C+A QuickCharge	N 10001296-130	13,06	1
	N 10001296-138	13,06	1
	N 10001296-230	14,15	1
	N 10001296-238	14,15	1

DESCRIPCIÓN	ARTÍCULO	PRECIO € Recomendado	PIEZAS CAJA
Tapa cargador USB 1 boca C	N 10001197-130	13,01	1
	N 10001197-138	13,01	1
	N 10001197-230	13,83	1
	N 10001197-238	13,83	1
Tapa salida de cables ancha	10002051-130	15,51	1
	10002051-138	15,51	1
	10002051-230	16,48	1
	10002051-238	16,48	1



KITS iO SIMON

	Kit front 1 elemento enchufe iO Simon	10021108-130	110,85	1
		10021108-138	110,85	1
		10021108-230	119,75	1
	Kit back 1 elemento enchufe iO Simon	10021108-238	119,75	1
		10010108-039	104,23	1
	Kit front 1 elemento interruptor iO Simon	10020112-130	98,65	1
		10020112-138	98,65	1
		10020112-230	106,41	1
		10020112-238	106,41	1
	Kit back 1 elemento interruptor iO Simon	10010112-039	92,77	1
	Kit front 1 elemento interruptor regulable iO Simon	10020114-130	105,92	1
		10020114-138	105,92	1
		10020114-230	114,28	1
		10020114-238	114,28	1
	Kit back 1 elemento interruptor regulable	10010113-039	93,49	1
	Kit front 1 elemento persianas iO Simon	10020116-130	103,73	1
		10020116-138	103,73	1
		10020116-230	111,88	1
		10020116-238	111,88	1
	Kit back persianas	10010115-039	86,40	1
	Kit front tecla máster iO Simon + tecla máster persianas iO Simon	10020117-130	192,39	1
		10020117-138	192,39	1
		10020117-230	208,14	1
		10020117-238	208,14	1
	Kit back 2x interruptores master iO Simon	10010117-039	188,36	1

COLECCIONES DE MECANISMOS

DESCRIPCIÓN	ARTÍCULO	PRECIO € Recomendado	PIEZAS CAJA
 Kit base de enchufe schuko HUB PRO iO Simon	10032108-130	443,05	1
	10032108-138	443,05	1
	10032108-230	465,26	1
	10032108-238	465,26	1

MECANISMOS iO SIMON

Enchufe iO	10002432-039	101,98	1
Interruptor regulable corte de fase 2/3 hilos	10000321-039	96,15	1
Interruptor regulable para tira de led (PWM)	10000314-039	112,34	1
Interruptor regulable para DALI	10000316-039	144,56	1
Interruptor regulable para 1-10V	10000317-039	133,83	1
Interruptor iO	10000322-039	90,51	1
Persianas	10001358-039	84,59	1
Interruptor Persianas lamas	10001359-039	148,92	1
Master iO	10000306-039	93,07	1
Termostato para calefacción/suelo radiante agua iO	10000810-130	217,05	1
Termostato para calefacción/suelo radiante agua iO	10000810-138	217,05	1
Termostato para suelo radiante eléctrico iO (incluye sonda)	10000811-130	235,54	1
Termostato para suelo radiante eléctrico iO (incluye sonda)	10000811-138	235,54	1

COMPLEMENTOS iO SIMON

HUB PRO iO Desktop	21032108-039	332,16	1
Interruptor (DIN) Apagado Total Iluminación iO	10002890-039	295,30	1
Micromódulo interruptor iO para Electroválvula	10002892-039	65,60	1
Sensor de humo iO	10002862-039	109,20	1
Sensor de agua iO	10002860-039	87,40	1
Sensor de Apertura/Cierre iO	10002214-039	65,60	1
Sensor de Movimiento iO	10002343-039	81,90	1
Sensor de Gas iO	10002861-039	98,30	1
Repetidor Z-wave con enchufe iO	10002880-039	65,60	1

TECLAS Y TAPAS iO SIMON

Frontal enchufe iO Simon	10002041-130	99,89	1
	10002041-138	99,89	1
	10002041-230	108,29	1
	10002041-238	108,29	1
Tecla interruptor regulable iO Simon	10002020-130	92,79	1
	10002020-138	92,79	1
	10002020-230	100,58	1
	10002020-238	100,58	1
Tecla interruptor iO Simon	10002034-130	85,32	1
	10002034-138	85,32	1
	10002034-230	92,49	1
	10002034-238	92,49	1
Tecla persianas iO Simon	10002080-130	90,56	1
	10002080-138	90,56	1
	10002080-230	98,17	1
	10002080-238	98,17	1
Tecla master pulsador iO Simon	10002035-130	95,82	1
	10002035-138	95,82	1
	10002035-230	103,86	1
	10002035-238	103,86	1
Tecla master regulable iO Simon	10002021-130	90,57	1
	10002021-138	90,57	1
	10002021-230	98,18	1
	10002021-238	98,18	1
Tecla master persianas iO Simon	10002081-130	90,57	1
	10002081-138	90,57	1
	10002081-230	98,18	1
	10002081-238	98,18	1

DESCRIPCIÓN	ARTÍCULO	PRECIO € Recomendado	PIEZAS CAJA
Tecla interruptor persianas lamas iO Simon	10002082-130	123,24	1
	10002082-138	123,24	1
	10002082-230	128,38	1
	10002082-238	128,38	1
Tecla Interruptor Master Doble iO Bienvenida/Adiós	10002036-130	107,59	1
	10002036-138	107,59	1
	10002036-230	115,53	1
	10002036-238	115,53	1
Tecla Interruptor Master Doble iO Centralización Persianas	10002037-130	107,59	1
	10002037-138	107,59	1
	10002037-230	115,53	1
	10002037-238	115,53	1
Tecla Interruptor Master Doble iO Personalizable	S10002038-130	118,36	1
	S10002038-138	118,36	1
	S10002038-230	127,07	1
	S10002038-238	127,07	1
Tecla master persianas lamas iO Simon	10002083-130	123,24	1
	10002083-138	123,24	1
	10002083-230	133,51	1
	10002083-238	133,51	1
Pulsador Master iO Baterías	10002135-130	165,25	1
	10002135-138	165,25	1
	10002135-230	180,13	1
	10002135-238	180,13	1
Persianas Master iO Baterías	10002181-130	170,69	1
	10002181-138	170,69	1
	10002181-230	186,04	1
	10002181-238	186,04	1

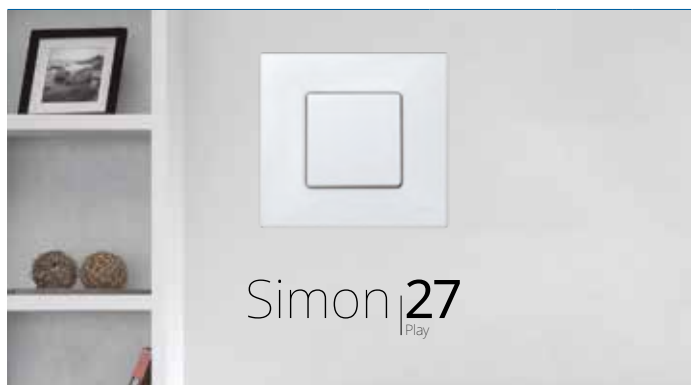

MECANISMOS

Portafusible 10A 220V	27000-31	7,34	20
	27000-34	7,14	20
Teclas persianas con enclavamiento	27028-32	4,67	20
	27028-35	4,50	20
Tapa baliza cortesía	27036-35	5,98	5
Tapa toma R-TV	27053-31	3,37	20
	27053-34	3,16	20
Tapa + boton regulador	27054-62	5,74	10
	27054-65	5,53	10
Tapa detector de presencia artº 75343-39	27060-32	4,67	5
	27060-35	4,50	5
Adaptador BNC y TNC	27075-32	7,66	10
	27075-35	7,66	10
	27078-30	9,32	5
Tapa tarjetero (para placas 2700613)	27078-31	9,94	5
	27078-38	11,26	5
Adaptador acodado 1 conector	27081-32	8,59	10
	27081-35	8,28	10
	27081-37	8,59	5
Adaptador acodado 2 conectores	27086-32	9,38	10
	27086-35	9,03	10
	27086-37	9,38	5
Tapa informática universal modulo estrecho	27087-31	5,55	10
	27087-34	5,20	10

DESCRIPCIÓN	ARTÍCULO	PRECIO € Recomendado	PIEZAS CAJA
Tapa informática universal modulo ancho	27087-32	7,89	10
	27087-35	7,60	10
	27087-37	7,89	10
Tapa portafusible	27089-34	3,12	20
	27089-35	3,01	20
Fusible 5 x 20 mm. 4A	27094-31	1,06	10
Fusibles 5 x 20 mm. 6,3A	27096-31	1,06	10
Tapa toma R-TV + SAT	27097-31	3,37	20
	27097-34	3,16	20
	27097-37	3,34	5
	27097-38	3,41	10
Interruptor unipolar mód. estre.	27101-61	4,74	20
	27101-64	4,61	20
Interruptor unipolar	27101-62	4,67	10
	27101-65	4,67	10
Interruptor unipolar con piloto mód. estre.	27102-61	14,16	20
	27102-64	13,76	20
Interruptor unipolar con piloto	27102-62	14,16	10
	27102-65	14,16	10
Interruptor unipolar con luminoso mód. estre.	27104-61	13,65	20
	27104-64	13,26	20
Interruptor unipolar con luminoso	27104-62	13,76	10
	27104-65	13,76	10
Fusible 5 x 20 mm. 10A	27110-31	1,06	10
Fusible 5 x 20 mm. 16A	27116-31	1,06	10
Interruptor bipolar 16A	27133-62	15,29	10
	27133-65	15,29	10
Interruptor bipolar 16A con piloto mód. estre.	27134-61	26,07	5
	27134-64	25,33	5
Interruptor bipolar 16A con piloto	27134-62	26,14	10
	27134-65	26,14	10
	27134-67	26,90	5
Pulsador campana mód. estre.	27150-61	7,22	20
	27150-64	6,76	20
Pulsador campana	27150-62	7,05	10
	27150-65	6,78	10
Pulsador luz mód. estre.	27151-61	7,35	20
	27151-64	6,89	20
Pulsador luz	27151-62	7,18	10
	27151-65	6,91	10
Pulsador de tirador	27153-62	16,95	10
	27153-65	16,63	10
Pulsador campana con luminoso mód. estre.	27160-61	15,77	20
	27160-64	14,76	20
Pulsador campana con luminoso	27160-62	15,45	10
	27160-65	14,87	10
Pulsador luz con luminoso mód. estre.	27161-61	16,05	20
	27161-64	15,05	20
Pulsador luz con luminoso	27161-62	15,81	10
	27161-65	15,23	10
Conmutador mód. estre.	27201-61	5,55	20
	27201-64	5,39	20
	27201-66	5,78	20
Conmutador	27201-62	5,41	10
	27201-65	5,41	10
	27201-67	6,03	10
Conmutador con piloto mód. estre.	27202-61	15,64	20
	27202-64	14,66	20
Conmutador con piloto	27202-62	15,82	10
	27202-65	15,24	10
Conmutador con luminoso mód. estre.	27204-61	15,39	20
	27204-64	14,43	20
Conmutador con luminoso	27204-62	15,61	10
	27204-65	15,04	10
	27204-67	15,61	10
Conmutador 16A mód. estre.	27211-61	9,68	5
	27211-64	9,41	5
Conmutador 16A	27211-62	9,71	10
	27211-65	9,71	10
Conmutador 16A con piloto	27212-62	19,03	10
	27212-65	18,33	10

DESCRIPCIÓN	ARTÍCULO	PRECIO € Recomendado	PIEZAS CAJA
Conmutador cruce mód. estre.	27251-61	14,77	20
	27251-64	14,35	20
Conmutador cruce	27251-62	14,34	10
	27251-65	14,34	10
Conmutador cruce con luminoso mód. estre.	27254-61	25,29	20
	27254-64	23,71	20
Conmutador cruce con luminoso	27254-62	24,82	10
	27254-65	23,91	10
Reg. electrónico tensión universal mód. estre.	27313-31	121,27	1
	27313-34	118,02	1
Grupo 2 pulsadores para persianas con enclavamiento eléctrico	27332-32	36,04	5
	27332-35	34,72	5
Interruptor persianas 3 posiciones mód. estre.	27333-61	33,75	5
	27333-64	31,64	5
Interruptor persianas 3 posiciones	27333-62	33,73	10
	27333-65	32,80	10
Detector de presencia mód. estre.	27342-31	176,86	1
	27342-34	167,39	1
Grupo 2 pulsadores para persianas sin enclavamiento	27396-62	20,26	10
	27396-65	19,51	10
Enchufe 2P 10A mód. estre.	27431-61	5,18	20
	27431-64	5,03	20
Enchufe 2P + seguridad	27431-62	6,68	10
	27431-65	6,68	10
Enchufe 2P + TT lateral schuko embornamiento rápido + seguridad	27432-62	5,88	10
	27432-65	5,88	10
	27432-68	6,75	10
Enchufe 2P mixta 10A mód. estre.	27438-31	9,56	20
	27438-34	9,29	20
Enchufe 2P + TT mixta 15A. 125 V~	27439-32	10,25	10
	27439-35	10,25	10
	27439-38	10,57	10
Enchufe 2P + TT desplazada 10A mód. estre.	27442-61	5,94	20
	27442-64	5,77	20
Enchufe 2P + TT tipo francés + seguridad	27458-32	12,38	10
	27458-35	12,38	10
Enchufe 2P + TT lateral schuko embornamiento a tornillo + seguridad	27472-62	5,88	10
	27472-65	5,88	10
	27472-67	6,05	10
Toma TV simple mód. estre.	27475-31	9,79	20
	27475-34	9,53	20
Toma teléfono 4 conexiones mód. estre.	27480-31	13,23	20
	27480-34	13,37	20
Toma teléfono 4 conexiones	27480-32	14,44	10
	27480-35	13,91	10
Toma teléfono 6 conexiones mód. estre.	27481-31	15,88	20
	27481-34	15,03	20
Toma teléfono 6 conexiones	27481-32	16,74	10
	27481-35	16,28	10
	27481-37	16,28	5
	27481-38	16,78	10
Tapa informática 2 conectores universal	27486-32	8,01	10
	27486-35	7,78	10
	27486-37	8,01	10
Adaptador 1 conector RJ-45 Ortonics	27488-32	7,53	10
	27488-35	7,32	10
Adaptador 2 conectores RJ-45 Ortonics	27489-32	9,26	10
	27489-35	9,00	10
Enchufe 2P +TT lateral schuko embornamiento a tornillo + seguridad, con tapa	27490-32	10,55	10
	27490-35	10,25	10
	27490-37	10,25	10
Tapa termostato empotrar	27505-32	10,21	5
	27505-35	10,21	5
Conmutador pulsador con llave	27520-62	104,27	1
	27520-65	104,27	1
	27520-68	106,34	1
Conmutador llave 2 posiciones	27521-62	104,27	1
	27521-65	104,27	1
	27521-68	106,34	1
Conmutador llave con enclavamiento	27522-62	114,16	1
	27522-65	114,16	1
	27522-68	116,44	1





COLECCIONES DE MECANISMOS

DESCRIPCIÓN	ARTÍCULO	PRECIO € Recomendado	PIEZAS CAJA
Conmutador llave 3 posiciones	27523-62	114,16	1
	27523-65	114,16	1
	27523-68	116,44	1
Tapa altavoz 2" 05562-39	27562-30	5,64	10
	27562-31	5,96	10
Pulsador neutro mód. estre.	27659-61	6,63	20
	27659-64	6,44	20
Pulsador neutro	27659-62	6,79	10
	27659-65	6,60	10
	27659-67	6,79	10
	27669-61	16,54	20
Pulsador neutro con luminoso mód. estre.	27669-64	15,65	20
	27669-62	15,77	10
Pulsador neutro con luminoso	27669-65	15,77	10
	27669-67	15,77	10
	27800-31	3,83	20
Placa ciega mód. estre.	27800-34	3,59	20
	27800-32	3,81	10
Placa ciega	27800-35	3,70	10
	27800-37	3,81	10
	27800-38	4,02	10
	27801-31	6,64	20
Salida cables mód. estre.	27801-34	6,40	20
	27801-32	6,61	10
Salida cables	27801-35	6,42	10
	27801-37	6,61	5
	27804-64	28,28	5
Interrupción para pasen/esperen mód. estre.	27805-64	38,21	5
Interrupción para pasen/esperen mód. ancho	27805-65	38,21	5
Zumbador	27806-32	26,80	10
	27806-35	26,04	10
Señalizador translúcido mód. estre.	27808-31	12,26	20
	27808-34	11,58	20
Señalizador rojo mód. estre.	27810-31	12,26	20
	27810-34	12,26	20
Garra suplementaria	27889-39	1,41	10
Pasacables unión cajas 27714	27891-31	1,88	10
Adaptador para carril DIN	27898-31	3,67	10
Tapa gama IR	27997-39	4,73	5
Bolsa con 10 juegos garras opcionales	27999-39	9,99	10
Tecla interruptor persianas 3 posiciones	2700033-038	3,34	10
Tapa enchufe 2P + TT lateral schuko + seguridad	2700041-038	2,70	10
Tapa enchufe 2P + TT lateral schuko + seguridad antibacteriana	2700041-060	2,77	5
Conector con tapa video VGA	2700091-030	30,95	1
	2700091-031	33,01	1
	2700091-038	32,15	1
Tapa conector fibra óptica	2700545-030	8,35	5
	2700545-031	8,91	5
	2700545-038	8,90	5
Soporte con led color rojo, para luminoso o piloto	2700802-037	9,83	10
Soporte con led color azul, para luminoso o piloto	2700802-064	9,83	10
Kit junta estanca para IP44 enchufes	2700950-030	8,85	5
Kit junta estanca para IP44 mecanismos	2700951-030	8,38	5
Conector con tapa USB A hembra mód. estre.	2701090-030	25,75	1
	2701090-031	26,73	1
	2701090-038	26,97	1
	2701092-030	25,75	1
Conector con tapa audio mini-jack mód. estre.	2701092-031	26,73	1
	2701092-038	26,97	1
	2701093-030	25,75	1
Conector con tapa audio-video 3 RCA mód. estre.	2701093-031	26,73	1
	2701093-038	26,97	1
	2701094-030	32,22	1
Conector con tapa HDMI mód. estre.	2701094-031	33,45	1
	2701094-038	34,09	1
	2701096-030	48,84	1
Cargador 2xUSB 5V/DC 2,1A	2701096-031	47,91	1
	2701096-038	52,22	1



DESCRIPCIÓN	ARTÍCULO	PRECIO € Recomendado	PIEZAS CAJA
Cargador USB 5vdc 2.1A Smartcharge	2701097-030	47,74	1
	2701097-031	49,09	1
	2701097-038	46,88	1
Mód. regulador trafo electromagnético 500 W	2721313-039	58,52	5
Mód. regulador trafo electrónico 400 W	2721316-039	61,86	5
Enchufe 2P+TT lateral schuko monoblock + seguridad	2791432-030	7,40	10
	2791432-031	7,62	10

TECLAS OPCIONALES

TECLAS MÓDULO ANCHO

	Tecla mód. ancho grafito	2720010-038	2,18	10
	Tecla mód. ancho azul translúcido	2720010-109	3,09	5
	Tecla mód. ancho rojo translúcido	2720010-110	3,09	5
	Tecla mód. ancho verde translúcido	2720010-111	3,09	5
	Tecla mód. ancho transparente	2720010-108	3,03	5
	Tecla mód. ancho fumé	2720010-112	3,09	5
	Tecla mód. ancho antibacteriana	2720010-060	3,03	5

TECLAS MÓDULO ESTRECHO

	Tecla mód. estre. grafito	2710010-038	1,95	10
	Tecla mód. estre. azul translúcido	2710010-109	2,92	5
	Tecla mód. estre. rojo translúcido	2710010-110	2,92	5
	Tecla mód. estre. verde translúcido	2710010-111	2,92	5
	Tecla mód. estre. fumé	2710010-112	2,92	5

PIEZAS INTERMEDIAS

PIEZAS INTERMEDIAS SIN TAPA ARTICULADA

	Pieza intermedia aluminio	2700670-033	3,24	20
	Pieza intermedia grafito	2700670-038	0,82	20
	Pieza intermedia oro	2700670-066	3,85	20
	Pieza intermedia azul translúcido	2700670-109	0,82	20
	Pieza intermedia rojo translúcido	2700670-110	0,82	20
	Pieza intermedia verde translúcido	2700670-111	0,82	20
	Pieza intermedia fumé	2700670-112	0,82	20







PIEZAS INTERMEDIAS CON TAPA ARTICULADA

	Pieza intermedia tapa articulada grafito	2700679-038	4,15	5
	Pieza intermedia tapa articulada azul translúcido	2700679-109	4,15	5
	Pieza intermedia tapa articulada rojo translúcido	2700679-110	4,15	5
	Pieza intermedia tapa articulada verde translúcido	2700679-111	4,15	5

DESCRIPCIÓN	ARTÍCULO	PRECIO € Recomendado	PIEZAS CAJA
 Pieza intermedia tapa articulada fumé	2700679-112	4,15	5

MARCOS

MARCOS (ADMITEN FUNDAS)

	1 elemento blanco	 2700610-030	2,93	20
	2 elementos blanco	 2700620-030	6,12	10
	3 elementos blanco	 2700630-030	10,07	10
	4 elementos blanco	2700640-030	13,95	10
	Pack 100 marcos 1 elemento con bastidor separado blanco	2702610-030	296,01	1
	Pack 50 marcos 2 elementos con bastidor separado blanco	2702620-030	308,45	1
	1 elemento marfil	 2700610-031	3,02	20
	2 elementos marfil	 2700620-031	6,30	10
	3 elementos marfil	2700630-031	10,75	10
	4 elementos marfil	2700640-031	14,88	10



MARCOS PARA PIEZAS INTERMEDIAS

	1 elemento para pieza intermedia	2701610-030	2,83	20
	2 elementos para pieza intermedia	2701620-030	5,64	10
	3 elementos para pieza intermedia	2701630-030	9,13	10
	4 elementos para pieza intermedia	2701640-030	12,68	10

MARCOS PARA CAJA UNIVERSAL PARA 1 MÓDULO ESTRECHO

	Marco para 1 mód. estre. caja universal	2702611-030	4,92	5
	Marco para 1 mód. estre. caja universal	2702611-031	5,11	5

MARCOS PARA CAJA AMERICANA

	Marco americano 1 mód. estre. blanca	2700611-030	4,92	5
	Marco americano 1 mód. estre. marfil	2700611-031	5,25	5
	Marco americano 2 mód. estre. o 1 mód. ancho blanca	2700612-030	5,03	10
	Marco americano 2 mód. estre. o 1 mód. ancho marfil	2700612-031	5,37	10
	Marco americano 3 mód. estre. o 1 mód. ancho y 2 mód. estre. blanca	2700613-030	5,55	10
	Marco americano 3 mód. estre. o 1 mód. ancho y 2 mód. estre. marfil	2700613-031	5,92	10
	Marco americano 4 mód. estre. o 2 mód. anchos blanca	2700614-030	5,85	5
	Marco americano 4 mód. estre. o 2 mód. anchos marfil	2700614-031	6,24	5

FUNDAS PARA MARCOS CAJA UNIVERSAL

GAMA COLOR

	1 elemento negro	2700617-071	1,62	10
	2 elementos negro	2700627-071	3,42	5
	3 elementos negro	2700637-071	5,13	5
	4 elementos negro	2700647-071	6,84	1

GAMA ARTIC

	1 elemento titanium	2700617-041	6,16	10
	2 elementos titanium	2700627-041	10,09	5
	3 elementos titanium	2700637-041	13,12	5
	4 elementos titanium	2700647-041	17,52	1

DESCRIPCIÓN	ARTÍCULO	PRECIO € Recomendado	PIEZAS CAJA	
	1 elemento rojo	2700617-080	6,16	10
	2 elementos rojo	2700627-080	10,09	5
	3 elementos rojo	2700637-080	13,12	5
	4 elementos rojo	2700647-080	17,52	1

	1 elemento amarillo	2700617-081	6,16	10
	2 elementos amarillo	2700627-081	10,09	5
	3 elementos amarillo	2700637-081	13,12	5
	4 elementos amarillo	2700647-081	17,52	1

	1 elemento naranja	2700617-082	6,16	10
	2 elementos naranja	2700627-082	10,09	5
	3 elementos naranja	2700637-082	13,12	5
	4 elementos naranja	2700647-082	17,52	1

	1 elemento verde	2700617-084	6,16	10
	2 elementos verde	2700627-084	10,09	5
	3 elementos verde	2700637-084	13,12	5
	4 elementos verde	2700647-084	17,52	1

	1 elemento berenjena	2700617-085	6,16	10
	2 elementos berenjena	2700627-085	10,09	5
	3 elementos berenjena	2700637-085	13,12	5
	4 elementos berenjena	2700647-085	17,52	1

	1 elemento negro	2700617-086	6,16	10
	2 elementos negro	2700627-086	10,09	5
	3 elementos negro	2700637-086	13,12	5
	4 elementos negro	2700647-086	17,52	1

GAMA METAL

	1 elemento inox	2700617-042	11,53	10
	2 elementos inox	2700627-042	21,34	5
	3 elementos inox	2700637-042	32,26	5
	4 elementos inox	2700647-042	47,70	1

GAMA EXTREM

	1 elemento gris helios	2700617-805	12,98	5
	2 elementos gris helios	2700627-805	24,25	1
	3 elementos gris helios	2700637-805	32,63	1
	4 elementos gris helios	2700647-805	39,30	1

FUNDAS TRANSPARENTES

	1 elemento transparente	2700617-108	3,21	10
	2 elementos transparente	2700627-108	6,82	5
	3 elementos transparente	2700637-108	10,20	5
	4 elementos transparente	2700647-108	13,59	1

	1 elemento gris translúcido	2700617-112	1,65	10
	2 elementos gris translúcido	2700627-112	3,42	5
	3 elementos gris translúcido	2700637-112	5,13	5
	4 elementos gris translúcido	2700647-112	6,84	1

FUNDAS ANTIBACTERIANAS

	1 elemento blanco	2700617-060	2,90	10
	2 elementos blanco	2700627-060	5,90	5
	3 elementos blanco	2700637-060	8,88	5
	4 elementos blanco	2700647-060	11,78	1

CAJAS DE EMPOTRAR Y DE SUPERFICIE

Caja empotrar tipo americano	27710-31	2,03	25
Caja empotrar placas para perfiles	27714-31	5,47	10
Caja superficie 1 mód. ancho o 2 estre.	27811-32	7,16	10
Caja superficie 1 mód. ancho o 2 estre.	27811-35	6,89	10
Caja superficie 2 mód. ancho o 4 estre.	27821-32	12,71	5
Caja superficie 2 mód. ancho o 4 estre.	27821-35	12,25	5
Caja superficie 3 mód. ancho o 6 estre.	27831-32	16,42	5
Caja superficie 3 mód. ancho o 6 estre.	27831-35	15,82	5
Caja superficie 1 elemento blanca	2700751-030	6,58	10

COLECCIONES DE MECANISMOS

DESCRIPCIÓN	ARTÍCULO	PRECIO € Recomendado	PIEZAS CAJA
Caja superficie 1 elemento marfil	2700751-031	6,83	10
Caja superficie 2 elementos blanca	2700752-030	11,82	5
Caja superficie 2 elementos marfil	2700752-031	12,27	5
Caja superficie 3 elementos blanca	2700753-030	15,36	5
Caja superficie 3 elementos marfil	2700753-031	15,94	5



Lámpara neón para centralizaciones	27802-39	10,51	10
Pasacables reversible centralizaciones	27890-32	3,17	10
Pasacables reversible centralizaciones	27890-35	3,05	10
Enlazadores eléctricos para enchufes	27996-39	3,40	20

CAJAS DE EMPOTRAR Y DE SUPERFICIE

Caja empotrar centralizaciones	27711-31	2,95	25
--------------------------------	----------	------	----



MECANISMOS, TECLAS Y TAPAS

Portafusibles	26001-39	7,30	10
Interruptor unipolar	26101-39	4,49	10
Interruptor unipolar con piloto	26102-39	12,51	10
Interruptor unipolar con luminoso	26104-39	12,51	10
Interruptor bipolar 16A con piloto	26134-39	22,90	10
Pulsador	26150-39	4,67	10
Pulsador con luminoso	26160-39	12,72	10
Conmutador	26201-39	5,47	10
Conmutador con piloto	26202-39	13,49	10
Conmutador con luminoso	26204-39	13,55	10
Conmutador cruce	26251-39	13,23	10
Conmutador cruce con luminoso	26254-39	21,36	10
Grupo 1 conmutador + 1 pulsador	26301-39	13,37	10
Interruptor persianas 3 posiciones	26333-39	25,33	10
Grupo 2 conmutadores	26397-39	15,24	10
Grupo 2 interruptores	26398-39	10,78	10
Enchufe 2P + TT schuko	26432-39	3,95	10
Enchufe 2P + TT tipo francés	26458-39	3,79	10
Interruptor-conmutador para tarjeta	26526-39	20,98	10
Int./conmut. para tarjeta 2 microrruptores	26550-39	22,21	10
SopORTE neón para mecanismos	26802-39	8,72	10
SopORTE neón para mecanismos	26803-39	8,72	10
Señalizador	26809-39	7,92	10
Tecla interruptores o conmutadores	28010-30	2,55	20
Tecla int. o conmut. con luminoso	28011-30	2,96	20

DESCRIPCIÓN	ARTÍCULO	PRECIO € Recomendado	PIEZAS CAJA
Tecla int. o conmut. con piloto	28012-30	2,96	20
Tecla campana pulsador con luminoso	28015-30	3,02	20
Tecla luz pulsador con piloto	28016-30	3,02	20
Tecla campana pulsador	28017-30	2,66	20
Tecla luz pulsador	28018-30	2,67	20
Tecla grupo 2 int. o 2 conmut.	28026-30	3,62	20
Tecla grupo 1 int. + 1 pulsador	28027-30	2,82	20
Tecla persianas	28028-30	3,96	20
Tecla interruptor persianas 3 posiciones	28033-30	6,04	5
Tapa enchufe 2P + TT lateral schuko + seguridad	28041-60	2,97	10
Tapa salida cables	28051-30	2,97	10
Tapa zumbadores	28052-30	2,97	10
Tapa toma R-TV	28053-30	2,53	10
Tapa + botón, regulador elec. 500 W	28054-30	5,13	10
Tapa + botón, regulador música ambiente	28055-30	5,14	10
Tapa portafusibles	28056-30	3,99	10
Tapa mec. con llave o toma altavoz mono	28057-30	2,69	10
Tapa toma teléfono	28062-30	2,91	10
Tapa difusor verde	28065-30	3,10	10
Tapa difusor translúcido	28065-31	2,74	10
Tapa difusor rojo	28065-32	2,74	10
Tapa enchufe 2P + seguridad	28067-30	6,31	10
Tapa enchufe 2P + TT francés + seguridad	28068-30	8,67	10
Tapa toma altavoz estéreo	28082-30	9,79	10
Adaptador 1 conector RJ-45 AMP	28085-30	10,48	10
Adaptador elementos 45x45 mm	28088-30	3,39	10
Adaptador 2 conectores RJ-45 AMP	28089-30	10,48	10
Placa doble cargador USB A+A	2811096-030	3,10	5
Tapa conector fibra óptica	28545-30	10,66	5
Placa ciega	28800-30	3,82	10
Enchufe 2P +TT lateral schuko + seguridad, monoblock	2890432-030	5,17	10

MARCOS

Marco 1 elemento blanca	28610-30	2,91	10
Marco 2 elementos blanca	28620-30	4,77	10
Marco 3 elementos blanca	28630-30	6,44	10
Marco 4 elementos blanca	28640-30	8,46	10

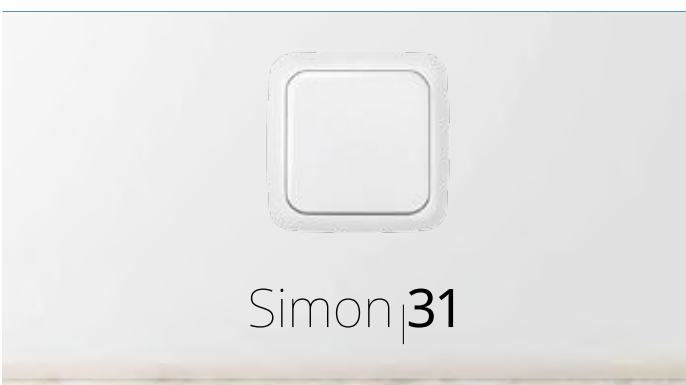

MECANISMO, TECLAS Y TAPAS



Tapa toma R-TV	31053-60	2,75	10
	31053-61	2,82	10
Tapa + botón regulador elec. 500 W	31054-30	9,34	10
	31054-31	9,60	10
Tapa informática conector universal	31085-60	15,74	5
	31085-61	16,18	5
Adaptador elementos 45x45 mm.	31088-30	6,11	10
	31088-31	6,28	10
Tapa informática 2 conectores universal	31089-60	16,42	5
	31089-61	16,88	5
Tapa RTV + SAT	31097-60	2,87	10
	31097-61	2,95	10

DESCRIPCIÓN	ARTÍCULO	PRECIO € Recomendado	PIEZAS CAJA
Interruptor unipolar	31101-30	13,76	10
	31101-31	14,15	10
Interruptor bipolar 16A	31133-30	26,28	10
	31133-31	27,01	10
Interruptor bipolar 16A con piloto	31134-30	34,49	10
	31134-31	35,45	10
Conmutador	31201-30	15,03	10
	31201-31	15,45	10
Conmutador con piloto	31202-30	31,59	10
	31202-31	32,47	10
Conmutador con luminoso	31204-30	27,93	10
	31204-31	28,71	10
Conmutador 16A	31211-30	17,71	10
	31211-31	18,20	10
Grupo 1 conmutador + 1 pulsador campana	31301-30	30,74	10
	31301-31	31,60	10
Grupo 2 pulsadores para persianas	31331-30	39,05	10
	31331-31	40,13	10
Interruptor persianas 3 posiciones	31333-60	37,16	10
	31333-61	38,19	10
Grupo 2 pulsadores	31396-30	26,17	10
	31396-31	26,90	10
Grupo 2 conmutadores	31397-30	32,20	10
	31397-31	33,09	10
Grupo 2 interruptores	31398-30	26,86	10
	31398-31	27,61	10
Enchufe 2P + TT schuko + seguridad (incluir tapa 31690)	31430-61	12,97	10
Enchufe 2P + seguridad	31431-60	13,01	10
	31431-61	13,37	10
Enchufe 2P + TT lateral schuko + seguridad	31432-60	12,74	10
	31432-61	13,09	10
Enchufe 2P + TT lateral schuko + seguridad rojo	31432-67	14,11	10
Enchufe 2P + TT lateral schuko sin garras + seguridad	31464-60	12,74	10
	31464-61	13,09	10
Enchufe 2P + TT lateral schuko + seguridad, monoblock	31472-60	13,25	10
	31472-61	13,61	10
Toma teléfono 4 conexiones	31480-30	18,83	10
	31480-31	19,35	10
Toma teléfono 6 conexiones	31481-30	21,79	10
	31481-31	22,39	10
Tapa conector fibra óptica	31545-30	16,58	5
	31545-31	17,04	5
Tapa altavoz 2" 05562-39	31562-30	6,02	10
	31562-31	6,19	10
Pulsador campana	31650-30	15,60	10
	31650-31	16,03	10
Pulsador luz	31651-30	15,60	10
	31651-31	16,03	10
Pulsador neutro con alojamiento pictograma	31659-30	15,11	10
	31659-31	15,53	10
Pulsador neutro	31659-60	15,11	10
	31659-61	15,53	10
Pulsador campana con luminoso	31660-30	26,16	10
	31660-31	26,89	10
Pulsador luz con luminoso	31661-30	25,99	10
	31661-31	26,71	10
Pulsador neutro con luminoso	31669-30	24,19	10
	31669-31	24,86	10
Tapa articulada para artículo 31430	31690-30	7,15	10
	31690-31	7,35	10
Plantilla para instalación de cajas para tabiques huecos	31702-61	17,80	5
Placa ciega	31800-30	10,66	10
	31800-31	10,96	10
Salida cables	31801-30	16,16	10
	31801-31	16,61	10
Zumbador	31806-30	36,91	10
	31806-31	37,93	10
Tapa para caja empotrar	31970-61	0,52	100



DESCRIPCIÓN	ARTÍCULO	PRECIO € Recomendado	PIEZAS CAJA
-------------	----------	-------------------------	----------------

MARCOS

PARA CAJA UNIVERSAL MATERIAL TERMOPLÁSTICO

	1 elemento blanco	31610-30	5,61	20
	2 elementos blanco	31620-30	9,43	10
	3 elementos blanco	31630-30	16,30	10
	4 elementos blanco	31640-30	23,45	10
	1 elemento marfil	31610-31	5,76	20
	2 elementos marfil	31620-31	9,68	10
	3 elementos marfil	31630-31	16,64	10
	4 elementos marfil	31640-31	24,08	10

PARA CAJA UNIVERSAL MATERIAL TERMOESTABLE

	1 elemento blanco	31611-30	3,95	20
	2 elementos blanco	31621-30	6,64	10
	3 elementos blanco	31631-30	12,62	10
	4 elementos blanco	31641-30	17,27	10
	1 elemento marfil	31611-31	4,06	20
	2 elementos marfil	31621-31	6,82	10
	3 elementos marfil	31631-31	12,97	10
	4 elementos marfil	31641-31	17,75	10

CAJAS DE EMPOTRAR Y DE SUPERFICIE

Caja empotrar univ. cuadrada pretroquelada	31710-61	0,66	250
Caja empotrar para artículo 31857	31711-31	2,82	10
Caja empotrar 1 elemento universal para tabiques huecos	31712-61	2,55	240
Caja empotrar 2 elementos universal para tabiques huecos	31722-61	4,70	100
Caja empotrar universal 3 elementos para tabiques huecos	31732-61	7,03	50
Caja empotrar universal 4 elementos para tabiques huecos	31742-61	9,23	25
Caja superficie baja	31750-30	11,15	10
	31750-31	11,46	10
Caja superficie alta	31751-30	12,82	10
	31751-31	13,18	10
Caja superficie alta (sin marco)	31753-30	7,38	10
	31753-31	7,59	10



ARTÍCULOS MONOBLOCK (COLORES: -50 BLANCO / -53 ALUMINIO)

Pulsador	73150-50	12,35	10
	73150-53	21,09	5
Conmutador	73201-50	9,13	10
	73201-53	20,42	5
Enchufe bipolar	73431-50	9,22	10
	73431-53	22,41	5
Enchufe 2P+TT lateral schuko + seguridad	73432-50	11,48	10
	73432-53	23,06	5
Enchufe doble precableado 2P+TT lateral schuko + seguridad	73433-50	29,02	5

COLECCIONES DE MECANISMOS

SERIES SUPERFICIE Y EMPOTRAR

DESCRIPCIÓN	ARTÍCULO	PRECIO € Recomendado	PIEZAS CAJA
ARTÍCULOS COMPONIBLES (COLORES: -60 BLANCO / -62 GRAFITO / -63 ALUMINIO)			
Tecla interruptor, conmutador y pulsador	73010-60	2,02	10
	73010-62	2,78	5
	73010-63	6,92	5
Tecla pulsador luz con luminoso	73016-60	3,54	10
	73016-62	4,32	5
	73016-63	8,21	5
Tecla pulsador campana	73017-60	2,84	10
	73017-62	3,49	5
	73017-63	6,67	5
Tecla pulsador luz	73018-60	2,84	10
	73018-62	3,49	5
	73018-63	6,67	5
Tecla grupo 2 interruptores	73026-60	3,54	10
	73026-62	4,32	5
	73026-63	8,21	5
Tapa enchufe 2P con seguridad	73040-60	2,89	10
	73040-62	3,54	5
	73040-63	10,04	5
Tapa enchufe 2P+TT lateral schuko + seguridad	73041-60	4,79	10
	73041-62	5,84	5
	73041-63	10,86	5
	73041-67	6,71	10
Tapa enchufe 2P+TT tipo frances + seguridad	73068-60	5,83	10
	73068-62	7,11	5
	73068-63	13,35	5
Soporte para 1 conector RJ-45 (keystone)	73085-60	10,71	10
	73085-62	14,27	5
	73085-63	27,33	5
Adaptador para 2 conectores teléf. o inform.	73086-60	11,53	10
	73086-62	15,29	5
	73086-63	29,18	5
Tapa tomas R-TV+SAT	73097-60	3,54	10
	73097-62	4,32	5
	73097-63	8,21	5
Toma teléfono conector RJ-11	73480-60	11,91	10
	73480-62	14,60	5
Soporte con 1 conector RJ-45 "Tool less"	73585-60	17,14	10
	73585-62	23,05	5
Soporte para 1 conector RJ-45 AVAYA	73593-60	10,94	10
	73593-62	14,65	5
Tapa ciega	73800-60	5,47	10
	73800-62	7,31	5
	73800-63	13,99	5
Regleta de derivación 3 bornes	73805-60	6,40	5
	73805-63	14,89	5

MECANISMOS			
Interruptor unipolar	73101-39	4,56	10
Pulsador	73150-39	5,25	10
Pulsador con luminoso	73160-39	9,48	10
Conmutador	73201-39	5,29	10
Conmutador cruce	73251-39	12,87	10
Grupo dos pulsadores	73396-39	11,37	10
Combinación dos interruptores	73398-39	10,79	10
Base enchufe bipolar	73431-39	3,60	20
Base enchufe bipolar con T.T. lateral	73432-39	3,95	10
Base enchufe 2p con T.T. francés	73458-39	7,36	10

MARCOS			
Marco para 1 elemento 75x75 mm blanco	73610-60	3,57	10
Marco para 1 elemento 75x75 mm grafito	73610-62	4,06	5
Marco para 1 elemento 75x75 mm aluminio	73610-63	9,35	5
Marco para 2 elementos posición horizontal 75x146 mm blanco	73620-60	6,92	5
Marco para 2 elementos posición horizontal 75x146 mm grafito	73620-62	8,89	5

DESCRIPCIÓN	ARTÍCULO	PRECIO € Recomendado	PIEZAS CAJA
Marco para 2 elementos posición horizontal 75x146 mm aluminio	73620-63	15,51	5
Marco para 2 elementos posición vertical 146x75 mm blanco	73621-60	6,92	5
Marco para 2 elementos posición vertical 146x75 mm grafito	73621-62	8,89	5
Marco para 2 elementos posición vertical 146x75 mm aluminio	73621-63	15,51	5
Marco 3 elementos horizontal blanco	73630-60	10,04	5
Marco 3 elementos horizontal grafito	73630-62	12,92	5
Marco 3 elementos horizontal aluminio	73630-63	21,33	5
Marco 3 elementos vertical blanco	73631-60	10,04	5
Marco 3 elementos vertical grafito	73631-62	12,92	5
Marco 3 elementos vertical aluminio	73631-63	21,33	5

MECANISMOS, TECLAS Y TAPAS

Toma R-TV+SAT única	73486-69	19,03	10
Toma R-TV+SAT intermedia	73487-69	19,03	10
Toma R-TV+SAT final	73488-69	19,03	10



MECANISMOS

Interruptor unipolar	75101-39	8,36	10
Interruptor unipolar con piloto	75102-39	21,18	10
Interruptor unipolar con luminoso	75104-39	17,40	10
Interruptor bipolar 16A	75133-39	17,72	10
Interruptor bipolar 16A con piloto	75134-39	25,54	10
Pulsador	75150-39	9,58	10
Pulsador de desconexión	75152-39	9,43	10
Pulsador con luminoso	75160-39	18,07	10
Conmutador	75201-39	10,05	10
Conmutador con piloto	75202-39	22,86	10
Conmutador de tirador	75203-39	27,91	10
Conmutador con luminoso	75204-39	19,36	10
Interruptor-conmutador 16A	75211-39	11,74	10
Conmutador rotativo 4 posiciones	75233-39	24,11	10
Conmutador cruce	75251-39	21,38	10
Conmutador cruce con luminoso	75254-39	32,45	10
Grupo 1 conmutador + 1 pulsador campana	75301-39	23,81	10
Interruptor-conmutador regulador de tacto	75305-69	117,36	1
Auxiliar regulador de tacto	75306-69	40,27	1
Regulador electrónico 300 W	75311-39	56,54	1
Regulador electrónico 1.000 W/VA	75312-39	221,01	1
Reg. electrón. de tensión para fluorescencia 3A	75317-39	128,68	1
Reg. electrón. universal, 500 W/VA	75319-39	138,45	1
Interruptor-conmutador tacto por relé	75322-69	119,41	1
Pulsador temporizado	75325-39	81,08	1
Grupo 2 pulsadores para persianas	75331-39	30,08	10
Interruptor persianas 3 posiciones	75333-39	28,20	10
Detector de presencia	75343-39	138,01	1
Mando a distancia	75350-69	108,06	1
Receptor para persianas IR 700 W/VA	75358-39	130,58	1
Baliza de cortesia	75370-39	78,38	1

DESCRIPCIÓN	ARTÍCULO	PRECIO € Recomendado	PIEZAS CAJA
Grupo 2 pulsadores con luminoso	75393-39	33,93	10
Grupo 2 conmut., con luminoso	75394-39	35,46	10
Grupo 2 pulsadores de desconexión	75395-39	18,55	10
Grupo 2 pulsadores	75396-39	18,55	10
Grupo 2 conmutadores	75397-39	24,38	10
Grupo 2 interruptores	75398-39	18,55	10
Grupo 2 pulsadores (1 ent. + 2 salidas)	75399-39	22,19	10
Base enchufe británica	75423-39	8,73	10
Enchufe 2P	75431-39	6,69	10
Enchufe 2P + TT lateral schuko embornamiento a tornillo	75432-39	6,43	10
Enchufe 2P + TT tipo francés	75458-39	9,86	10
Enchufe 2P + TT schuko embornamiento rápido	75464-39	6,39	10
Toma RTV-SAT modular única	75466-69	18,97	10
Toma RTV-SAT modular intermedia	75467-69	18,97	10
Toma RTV-SAT modular final	75468-69	18,97	10
Toma teléfono 4 conexiones	75480-30	12,90	10
	75480-31	13,26	10
	75480-32	13,42	10
Toma teléfono 6 conexiones	75481-30	15,60	10
	75481-31	16,03	10
	75481-32	16,38	10
Toma R-TV única	75486-39	15,46	10
Toma R-TV intermedia	75487-39	15,46	10
Toma R-TV final	75488-39	15,46	10
Termostato empotrar calor con contacto ventana	75500-39	89,78	1
Termostato empotrar frío-calor	75503-39	103,02	1
Conector modular 6 conec. RJ-11/12	75528-39	21,68	5
Conector RJ-45 AMP	75540-39	21,49	5
Conector RJ-45 apantallado AMP	75541-39	35,39	5
Conector RJ-45 AWAYA	75542-30	37,12	10
	75542-31	37,84	10
	75542-32	39,16	10
	75542-37	39,16	10
Conector RJ-45 Cat 6 SL AMP	75544-39	24,30	5
Pulsador 24V con LED color rojo	75552-39	20,24	10
Pulsador 24V con LED color verde	75553-39	19,86	10
Interruptor para tarjeta temporizado	75558-39	73,70	1
Salida cables	75801-39	11,25	10
Lámpara incandescencia 3 W 220 V	75802-39	7,41	10
	75803-39	7,41	10
Pasen-Esperen	75804-39	65,37	1
Mecanismo visor individual Pasen-Esperen	75805-39	49,23	1
Zumbador	75806-39	27,35	10
Lámpara de balizado autónomo	75809-39	100,38	1
Conector VGA HD15 hembra + mini-jack	7500091-039	49,08	1
Conector VGA HD15 hembra + 3RCA	7500092-039	66,13	1
Regulador-pulsador trafo electromagnético 500 W	7500313-039	60,71	5
Regulador-pulsador trafo electrónico 400 W	7500316-039	66,41	5
Base enchufe británica con interruptor	7500422-039	8,73	10
Conmutador/pulsador a llave	7500520-039	159,73	1
Conmutador a llave sin enclavamiento	7500521-039	159,73	1
Conmutador a llave con enclavamiento	7500522-039	160,87	1
Conmutador llave 3 posiciones	7500523-039	160,87	1
Conmutador tarjeta 1 microrruptor 6A	7500526-039	21,81	5
Conector fibra óptica duplex sc/apc	7500546-039	35,23	1
Conmutador tarjeta 2 microrruptores 6A	7500550-039	23,12	5
Pack de 10 garras para nuevos mecanismos S75	7500999-039	9,80	10
Conector 2xUSB 2.0 tipo A hembra	7501090-039	37,33	1
Conector mini-jack + 2RCA	7501092-039	37,06	1
Conector HDMI v1.4 hembra	7501094-039	33,95	1
Conector HDMI v1.4 + USB 2.0 tipo A hembra	7501095-039	47,01	1
Regulador electrónico 450W	7501313-039	84,28	1
Regulador para LED	7502313-039	84,28	1
Base schuko con doble cargador USB 2.1A	7501432-039	50,38	1
Conector HDMI v2.0 hembra	7511094-039	75,05	1
Conector HDMI v2.0 + USB 2.0 tipo A	7511095-039	72,21	1
Cargador 2xUSB 5Vdc 2.1A tipo A hembra	7511096-039	47,85	1
Doble Cargador USB C+A QuickCharge 3.1A	7511296-039	53,92	1

DESCRIPCIÓN	ARTÍCULO	PRECIO € Recomendado	PIEZAS CAJA
Cruzamiento doble 10A	7502251-039	37,07	10
Pulsador doble 10A con luminoso azul	7502393-039	34,74	10
Conmutador doble 10AX con luminoso azul	7502394-039	35,46	10
Cargador USB doble C+A 3.1A PowerDelivery	7511296-039	53,92	1
Base schuko con cargador USB C+A	7511432-039	59,22	1
Base schuko con cargador USB C+C	7521432-039	68,22	1



MECANISMOS

Interruptor unipolar	7700101-039	8,52	10
Interruptor unipolar 16 AX con piloto	7700112-039	21,46	5
Pulsador	7700150-039	9,77	10
Pulsador con luminoso	7700160-039	18,42	10
Conmutador	7700201-039	10,24	10
Conmutador 16 AX	7700211-039	11,54	5
Conmutador de cruce	7700251-039	21,79	10
Soporte con led color rojo	7700802-037	10,27	5
Soporte con led color azul	7700802-064	10,27	5

Nuevas teclas Simon 82 con visor en pag. 54.



TECLAS Y TAPAS

Adaptador conector RJ45 AMP serie inclinada	75001-39	0,86	25
Adaptador conector RJ45 Systemax serie inclinada	75002-39	0,87	25
Adaptador conector RJ45 Pouyet serie inclinada	75003-39	0,88	25
Adaptador conector RJ45 Panduit serie inclinada	75004-39	0,88	25
Tapa conector fibra óptica	7500545-030	13,98	5
	7500545-031	14,37	5
Tecla interruptores o conmutadores	75010-30	3,03	20
	75010-31	3,11	20
Tecla int. o conmutadores con luminoso	75011-30	3,14	20
	75011-31	3,22	20
Tecla int. o conmutadores con piloto	75012-30	3,14	5
	75012-31	3,22	5
Tecla pulsador luz con luminoso	75016-30	3,35	20
	75016-31	3,45	20
Tecla pulsador campana	75017-30	3,03	20
	75017-31	3,11	20
Tecla pulsador luz	75018-30	3,03	10
	75018-31	3,11	5



COLECCIONES DE MECANISMOS

SERIES SUPERFICIE Y EMPOTRAR

DESCRIPCIÓN	ARTÍCULO	PRECIO € <small>Recomendado</small>	PIEZAS CAJA
Tecla grupo 2 int., conmut. o pulsadores	75026-30	4,51	20
	75026-31	4,63	20
Tecla grupo 1 conmut. + 1 pulsador	75027-30	4,61	5
	75027-31	4,73	5
Tecla persianas con enclavamiento	75028-30	4,80	20
	75028-31	4,93	20
Tecla interruptor bipolar 16A	75031-30	3,50	10
	75031-31	3,60	5
Tecla interruptor bipolar 16A con piloto	75032-30	3,68	5
	75032-31	3,78	5
Tecla interruptor persianas 3 posiciones	75033-30	4,80	10
	75033-31	4,93	10
Tapa + botón, reg. electrón. 1.000 W	75035-30	16,95	5
	75035-31	17,42	5
Tapa enchufe 2P + seguridad	75040-60	4,37	10
Tapa enchufe 2P + TT lateral schuko + seguridad	75041-60	4,37	10
	75041-61	4,49	10
Tapa salida de cables	75051-30	3,72	10
	75051-31	3,82	10
Tapa zumbador o altavoz 2" 05562-39	75052-30	3,67	5
	75052-31	3,77	5
Tapa toma R-TV	75053-30	3,58	20
	75053-31	3,68	20
Tapa + botón, regulador elec. 500 W	75054-30	7,17	10
	75054-31	7,36	10
Tapa toma de teléfono	75062-30	3,82	20
	75062-31	3,92	20
Tapa difusor verde	75065-30	4,07	5
Tapa difusor translúcido	75065-31	4,18	5
Tapa difusor rojo	75065-32	4,25	5
Tapa gama IR	75080-30	3,13	5
	75080-31	3,21	5
Adaptador elementos 45x45 mm	75088-30	4,61	10
	75088-31	4,73	10
Tapa articulada enchufe 2P + TT schuko + seg.	75090-60	12,77	5
	75090-61	13,13	5
Tapa toma R-TV + SAT	75097-30	3,58	20
	75097-31	3,68	20
Tapa informatica universal	75585-60	13,62	5
	75585-61	14,00	5
Tapa informatica 2 conectores universal	75589-60	14,03	5
	75589-61	14,42	5
Placa ciega	75800-30	8,40	10
	75800-31	8,63	10

PIEZAS INTERMEDIAS

 Pieza intermedia blanco	75900-39	2,28	20
Pieza intermedia marrón	75901-39	2,77	20
Pieza intermedia gris	75902-39	2,77	20
Pieza intermedia roja	75903-39	2,77	20
Pieza intermedia azul	75904-39	2,77	20
Pieza intermedia verde	75905-39	2,77	20
Pieza intermedia oro	75906-39	8,55	20
Pieza intermedia negra	75907-39	2,77	20
Pieza intermedia amarilla	75908-39	2,77	20
Pieza intermedia rosa	75909-39	2,53	20
Pieza intermedia marfil	75910-39	2,28	20
Pieza intermedia plata	75911-39	8,04	20
Pieza intermedia lila	75912-39	2,77	20
Pieza intermedia menta	75913-39	2,53	20
Pieza intermedia grafito	75918-39	2,82	20







DESCRIPCIÓN	ARTÍCULO	PRECIO € <small>Recomendado</small>	PIEZAS CAJA
MARCOS			
 1 elemento blanco	75610-30	3,87	10
2 elementos blanco	75620-30	6,24	10
3 elementos blanco	75630-30	11,60	10
4 elementos blanco	75640-30	16,93	10
 1 elemento marfil	75610-31	3,98	10
2 elementos marfil	75620-31	6,41	10
3 elementos marfil	75630-31	11,93	10
4 elementos marfil	75640-31	17,40	10

CAJAS DE SUPERFICIE

Caja superficie baja 1 elemento blanco nieve	75750-30	7,02	10
Caja superficie baja 1 elemento marfil	75750-31	7,22	10
Caja superficie baja 1 elemento negro	75750-32	7,84	10
Caja superficie alta 1 elemento blanco nieve	75751-30	7,31	10
Caja superficie alta 1 elemento marfil	75751-31	7,51	10
Caja superficie alta 1 elemento negro	75751-32	8,21	10
Caja superficie baja 2 elementos blanco nieve	75760-30	12,03	5
Caja superficie baja 2 elementos negro	75760-32	13,53	5
Caja superficie alta 2 elementos blanco nieve	75761-30	12,60	5
Caja superficie alta 2 elementos marfil	75761-31	12,95	5
Caja superficie alta 2 elementos negro	75761-32	14,16	5

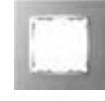

MARCOS

 1 elem. blanco mate	8200617-090	2,99	10
2 elem. blanco mate	8200627-090	5,74	10
3 elem. blanco mate	8200637-090	8,05	5
4 elem. blanco mate	8200647-090	10,27	5
 1 elem. gris	8200617-092	5,46	10
2 elem. gris	8200627-092	10,43	10
3 elem. gris	8200637-092	14,81	5
4 elem. gris	8200647-092	19,12	5
 1 elem. aluminio	8200617-093	7,43	5
2 elem. aluminio	8200627-093	14,19	5
3 elem. aluminio	8200637-093	20,17	1
4 elem. aluminio	8200647-093	25,66	1
 1 elem. cava	8200617-094	7,43	5
2 elem. cava	8200627-094	14,19	5
3 elem. cava	8200637-094	20,17	1
4 elem. cava	8200647-094	25,66	1
 1 elem. oro	8200617-095	8,03	5
2 elem. oro	8200627-095	15,32	5
3 elem. oro	8200637-095	21,78	1
4 elem. oro	8200647-095	27,70	1
 1 elem. titanio	8200617-096	7,62	5
2 elem. titanio	8200627-096	14,55	5
3 elem. titanio	8200637-096	20,69	1
4 elem. titanio	8200647-096	26,32	1

DESCRIPCIÓN	ARTÍCULO	PRECIO € Recomendado	PIEZAS CAJA
 1 elem. negro mate	8200617-098	5,88	10
2 elem. negro mate	8200627-098	11,21	10
3 elem. negro mate	8200637-098	15,94	5
4 elem. negro mate	8200647-098	20,56	5

CONJUNTOS SEMI-MONTADOS (MECANISMOS + TECLA / TAPA)

Interruptor unipolar 10 AX emb. rápido + tecla	8200101-090	11,18	10
	8200101-093	12,01	10
	8200101-094	12,01	10
	8200101-096	13,41	10
	8200101-098	11,67	10
Conmutador 10AX emb. rápido + tecla	8200201-090	12,52	10
	8200201-093	13,44	10
	8200201-094	13,44	10
	8200201-096	15,00	10
	8200201-098	13,06	10
Cruzamiento 10AX emb. rápido + tecla	8200251-090	22,42	5
	8200251-093	23,87	5
	8200251-094	23,87	5
	8200251-096	25,61	5
	8200251-098	23,61	5
Doble Conmutador 10AX emb. rápido + teclas	8200397-090	29,06	5
	8200397-093	29,68	5
	8200397-094	29,68	5
	8200397-096	30,26	5
	8200397-098	29,84	5
Doble Interruptor 10AX emb. rápido + teclas	8200398-090	23,43	5
	8200398-093	24,41	5
	8200398-094	24,41	5
	8200398-096	24,69	5
	8200398-098	24,06	5
Base de Enchufe 16A emb. tornillo + tapa	8200432-090	11,07	10
	8200432-093	12,30	10
	8200432-094	12,30	10
	8200432-096	14,28	10
	8200432-098	11,71	10
Base de enchufe schuko + doble cargador USB + tapa	8201432-030*	50,28	10
	8201432-038*	50,86	10
	8201432-090*	50,28	10
	8201432-093*	51,87	10
	8201432-094*	51,87	10
	8201432-096*	52,29	10
	8201432-098*	50,42	10

TECLAS Y TAPAS

Placa v&d univ. plana c/g polvo para 1 RJ45	8200005-090	12,30	5
	82005-93	14,26	5
	8200005-094	13,86	5
	8200005-096	16,21	5
	8200005-098	13,30	5
Placa v&d univ. plana c/g polvo para 2 RJ45	8200006-090	12,40	5
	82006-93	14,48	5
	8200006-094	14,08	5
	8200006-096	16,46	5
	8200006-098	13,50	5
Tecla individual para mecanismos	8200010-090	4,22	20
	82010-93	4,77	20
	8200010-094	4,77	20
	8200010-096	6,13	20
	8200010-098	4,63	20
Tecla indiv. pulsador con visor+luz	8200016-090	5,18	10
	82016-93	7,18	10
	8200016-094	6,85	10
	8200016-096	7,26	10
	8200016-098	5,61	10

DESCRIPCIÓN	ARTÍCULO	PRECIO € Recomendado	PIEZAS CAJA
Tecla individual pulsador con campana	8200017-090	4,59	10
	82017-93	5,73	10
	8200017-094	5,57	10
	8200017-096	6,40	10
	8200017-098	4,93	10
Tecla doble para mecanismos	8200026-090	5,93	10
	82026-93	6,93	10
	8200026-094	6,87	10
	8200026-096	6,94	10
	8200026-098	6,39	10
Tecla doble persianas con enclavamiento	8200028-090	5,85	20
	82028-93	8,04	20
	8200028-094	7,67	10
	8200028-096	8,20	20
	8200028-098	6,31	20
Tecla doble persianas sin enclavamiento	8200029-090	6,17	5
	82029-93	8,49	5
	8200029-094	8,10	10
	8200029-096	8,65	5
	8200029-098	6,68	5
Tecla indiv. mecanismo persianas 1-0-2	8200033-090	6,17	10
	82033-93	8,18	10
	8200033-094	7,80	10
	8200033-096	8,65	10
	8200033-098	6,68	10
Tapa para base de enchufe schuko	8200041-090	4,84	10
	82041-93	6,53	10
	8200041-094	6,46	10
	8200041-096	8,16	10
	8200041-098	5,50	10
Tapa para base de enchufe schuko con 2 bocas carga USB 2.1A tipo A	8200049-090	5,70	5
	8200049-093	7,47	5
	8200049-094	7,47	10
	8200049-096	7,87	5
	8200049-098	6,04	5
Tapa base enchufe schuko con 2 USB C+A	8200050-030	6,12	5
	8200050-031	6,30	5
	8200050-033	8,24	5
	8200050-034	8,24	5
	8200050-038	6,47	5
	8200050-090	5,70	5
	8200050-093	7,47	5
	8200050-094	7,47	5
	8200050-096	7,87	5
	8200050-098	6,04	5
Tapa salida de cables	8200051-090	5,19	10
	82051-93	7,09	10
	8200051-094	6,76	10
	8200051-096	7,28	10
	8200051-098	5,62	10
Tapa para zumbador/timbre	8200052-090	5,94	5
	82052-93	7,96	5
	8200052-094	7,60	5
	8200052-096	7,82	5
	8200052-098	6,38	5
Placa toma R-TV	8200053-090	5,20	20
	82053-93	6,11	20
	8200053-094	6,11	10
	8200053-096	6,86	20
	8200053-098	5,60	20
Placa mecanismo electrónico giratorio	8200054-090	7,86	5
	82054-93	10,33	5
	8200054-094	10,33	5
	8200054-096	11,01	5
	8200054-098	8,47	5

COLECCIONES DE MECANISMOS

SERIES SUPERFICIE Y EMPOTRAR

DESCRIPCIÓN	ARTÍCULO	PRECIO € Recomendado	PIEZAS CAJA
Tapa base enchufe schuko con 2 USB C+C	8200061-030	6,12	5
	8200061-031	6,30	5
	8200061-033	8,24	5
	8200061-034	8,24	5
	8200061-038	6,47	5
	8200061-090	5,70	5
	8200061-093	7,47	5
	8200061-094	7,47	5
	8200061-096	7,87	5
8200061-098	6,04	5	
Placa para tomas telefónicas RJ11 y RJ12	8200062-090	5,04	20
	82062-93	7,15	20
	8200062-094*	7,15	20
	8200062-096	7,09	20
	8200062-098	5,45	20
Tapa enchufe 2P+TT francesa+seguridad	82068-090*	5,68	10
	82068-93	7,19	5
	82068-094*	7,19	10
	82068-096*	8,02	10
	82068-098*	5,94	10
Tapa con visor interruptor de tarjeta	8200078-090	10,57	5
	82078-93	11,89	5
	8200078-094	11,89	5
	8200078-096	14,85	5
Placa para toma inductiva de R-TV+SAT	8200097-090	5,03	20
	82097-93	6,27	20
	8200097-094	6,27	5
	8200097-096	7,07	20
	8200097-098	5,44	20
Tecla individual mecanismos S75 con visor	8200111-090	4,88	5
	82011-93	6,72	5
	8200111-094	6,41	5
	8200111-096	6,86	5
	8200111-098	5,27	5
Tapa conector fibra óptica	8200545-090	13,66	5
	8200545-093	16,00	5
	8200545-094	16,00	5
	8200545-096	19,12	5
	8200545-098	17,16	5
Tapa ciega	8200800-090	8,45	10
	82800-93	10,25	10
	8200800-094	10,25	10
	8200800-096	11,86	10
	8200800-098	9,14	10
Tecla individual mecanismos S77 con visor	8201111-090	4,88	5
	8200011-093	6,55	20
	8201111-094	6,55	5
	8201111-096	6,86	5
	8201111-098	5,27	5
Placa conector HDMI	8201094-090	3,96	1
	8201094-093	5,74	1
	8201094-094	5,48	1
	8201094-096	5,72	1
	8201094-098	4,40	1
Placa cargador 2xUSB 5V 2.1A	8221096-090	4,48	1
	8221096-093	5,63	1
	8221096-094	5,63	1
	8221096-096	6,01	1
	8221096-098	5,22	1
Tecla doble para doble cruzamiento	8202126-090	5,64	5
	8202026-093	7,35	5
	8202126-094	7,28	1
	8202126-096	7,93	5
	8202126-098	6,10	5
Placa Doble Cargador USB C+A QuickCharge	8201296-090	5,08	1
	8201296-093	5,24	1
	8201296-094	6,15	1
	8201296-096	6,85	1
	8201296-098	5,94	1

DESCRIPCIÓN ARTÍCULO PRECIO € Recomendado PIEZAS CAJA



MARCOS ORIGINAL

BLANCO

MARCOS DETAIL BLANCO

	1 elem. blanco	8200610-030	3,40	10
	2 elem. blanco	8200620-030	5,41	10
	3 elem. blanco	8200630-030	10,13	5
	4 elem. blanco	8200640-030	13,31	1
	1 elem. blanco cálido	8200610-029	3,40	10
	2 elem. blanco cálido	8200620-029	5,41	10
	3 elem. blanco cálido	8200630-029	10,13	5
	4 elem. blanco cálido	8200640-029	13,31	1
	1 elem. blanco mate base blanca	8200610-130	4,97	10
	2 elem. blanco mate base blanca	8200620-130	7,88	10
	3 elem. blanco mate base blanca	8200630-130	14,29	5
	4 elem. blanco mate base blanca	8200640-130	19,13	5
	1 elem. marfil	8200610-031	3,40	10
	2 elem. marfil	8200620-031	5,41	10
	3 elem. marfil	8200630-031	10,13	5
	4 elem. marfil	8200640-031	13,31	1

MARCOS DETAIL PREMIUM

	1 elem. blanco base aluminio	8200610-230	8,11	5
	2 elem. blanco base aluminio	8200620-230	13,62	1
	3 elem. blanco base aluminio	8200630-230	19,18	1
	4 elem. blanco base aluminio	8200640-230	24,39	1

TITANIO

	1 elem. titaniO base negra	8200610-296	10,02	10
	2 elem. titaniO base negra	8200620-296	19,35	5
	3 elem. titaniO base negra	8200630-296	27,21	1
	4 elem. titaniO base negra	8200640-296	34,66	1

GRAFITO

MARCOS DETAIL PREMIUM

	1 elem. grafito base aluminio	8200610-238	9,48	5
	2 elem. grafito base aluminio	8200620-238	15,91	1
	3 elem. grafito base aluminio	8200630-238	22,42	1
	4 elem. grafito base aluminio	8200640-238	28,44	1

MARCOS DETAIL AIR

	1 elem. grafito base blanca	8200610-038	7,97	5
	2 elem. grafito base blanca	8200620-038	12,93	1
	3 elem. grafito base blanca	8200630-038	23,58	1
	4 elem. grafito base blanca	8200640-038	31,54	1

DESCRIPCIÓN



ARTÍCULO PRECIO € PIEZAS CAJA
Recomendado

DESCRIPCIÓN

ARTÍCULO PRECIO € PIEZAS CAJA
Recomendado

ALUMINIO

MARCOS DETAIL AIR

	1 elem. aluminio frío base blanca	8200610-093	9,62	10
	2 elem. aluminio frío base blanca	8200620-093	18,60	5
	3 elem. aluminio frío base blanca	8200630-093	26,16	1
	4 elem. aluminio frío base blanca	8200640-093	33,32	1
	1 elem. aluminio frío base negra	8200610-293	9,62	10
	2 elem. aluminio frío base negra	8200620-293	18,60	5
	3 elem. aluminio frío base negra	8200630-293	26,16	1
	4 elem. aluminio frío base negra	8200640-293	33,32	1





NEGRO

	1 elem. negro mate base negra	8200610-198	8,53	10
	2 elem. negro mate base negra	8200620-198	13,84	10
	3 elem. negro mate base negra	8200630-198	25,24	5
	4 elem. negro mate base negra	8200640-198	33,42	5

MARCOS SELECT

BLANCO

MARCOS DETAIL METAL

	1 elem. blanco base aluminio	8201610-243	16,84	5
	2 elem. blanco base aluminio	8201620-243	28,80	1
	3 elem. blanco base aluminio	8201630-243	40,55	1
	4 elem. blanco base aluminio	8201640-243	51,49	1
	1 elem. blanco base cromo	8201610-244	18,17	5
	2 elem. blanco base cromo	8201620-244	31,07	1
	3 elem. blanco base cromo	8201630-244	43,80	1
	4 elem. blanco base cromo	8201640-244	55,61	1
	1 elem. blanco base oro	8201610-245	18,85	1
	2 elem. blanco base oro	8201620-245	32,24	1
	3 elem. blanco base oro	8201630-245	45,42	1
	4 elem. blanco base oro	8201640-245	57,67	1
	1 elem. blanco base cava	8201610-294*	18,17	10
	2 elem. blanco base cava	8201620-294*	31,07	10
	3 elem. blanco base cava	8201630-294*	43,80	5
	4 elem. blanco base cava	8201640-294*	55,61	5
	1 elem. blanco base cobre	8201610-291*	18,17	10
	2 elem. blanco base cobre	8201620-291*	31,07	10
	3 elem. blanco base cobre	8201630-291*	43,80	5
	4 elem. blanco base cobre	8201640-291*	55,61	5

MARCOS DETAIL MADERA NATURAL

	1 elem. blanco base madera	8201610-270	31,71	1
	2 elem. blanco base madera	8201620-270	51,52	1
	3 elem. blanco base madera	8201630-270	96,38	1
	4 elem. blanco base madera	8201640-270	128,95	1

(Haya 100% certificado PEFC)



MARFIL

MARCOS DETAIL MARFIL METAL

	Marco 1 elem. marfil base cava	8201610-248	18,56	1
	Marco 2 elem. marfil base cava	8201620-248	31,75	1
	Marco 3 elem. marfil base cava	8201630-248	44,74	1
	Marco 4 elem. marfil base cava	8201640-248	56,83	1

GRAFITO

MARCOS DETAIL METAL

	1 elem. grafito base aluminio	8201610-240	16,84	5
	2 elem. grafito base aluminio	8201620-240	28,80	1
	3 elem. grafito base aluminio	8201630-240	40,55	1
	4 elem. grafito base aluminio	8201640-240	51,49	1
	1 elem. grafito base cromo	8201610-241	18,17	5
	2 elem. grafito base cromo	8201620-241	31,07	1
	3 elem. grafito base cromo	8201630-241	43,80	1
	4 elem. grafito base cromo	8201640-241	55,61	1
	1 elem. grafito base oro	8201610-242	18,85	1
	2 elem. grafito base oro	8201620-242	32,24	1
	3 elem. grafito base oro	8201630-242	45,42	1
	4 elem. grafito base oro	8201640-242	57,67	1

MARCOS DETAIL MADERA NATURAL

	1 elem. grafito base madera	8201610-271	32,27	1
	2 elem. grafito base madera	8201620-271	52,43	1
	3 elem. grafito base madera	8201630-271	98,04	1
	4 elem. grafito base madera	8201640-271	131,17	1

(Haya 100% certificado PEFC)





ALUMINIO

MARCOS DETAIL METAL

	1 elem. aluminio frío base cromo	8201610-093	18,53	5
	2 elem. aluminio frío base cromo	8201620-093	31,71	5
	3 elem. aluminio frío base cromo	8201630-093	44,66	1
	4 elem. aluminio frío base cromo	8201640-093	56,70	1

NEGRO

MARCOS DETAIL METAL

	1 elem. All Black	8201610-398	19,27	10
	2 elem. All Black	8201620-398	32,94	10
	3 elem. All Black	8201630-398	46,44	5
	4 elem. All Black	8201640-398	58,94	5
	1 elem. negro mate base cava	8201610-394	19,27	10
	2 elem. negro mate base cava	8201620-394	32,94	10
	3 elem. negro mate base cava	8201630-394	46,44	5
	4 elem. negro mate base cava	8201640-394	58,94	5
	1 elem. negro mate base cromo	8201610-344*	19,27	10
	2 elem. negro mate base cromo	8201620-344*	32,94	10
	3 elem. negro mate base cromo	8201630-344*	46,44	5
	4 elem. negro mate base cromo	8201640-344*	58,94	5
	1 elem. negro mate base cobre	8201610-391*	19,27	10
	2 elem. negro mate base cobre	8201620-391*	32,94	10
	3 elem. negro mate base cobre	8201630-391*	46,44	5
	4 elem. negro mate base cobre	8201640-391*	58,94	5
	1 elem. negro mate base oro	8201610-395*	19,98	10
	2 elem. negro mate base oro	8201620-395*	34,17	10
	3 elem. negro mate base oro	8201630-395*	48,14	5
	4 elem. negro mate base oro	8201640-395*	61,12	5

MARCOS DETAIL MADERA NATURAL

	1 elem. negro mate base madera	8201610-370*	34,21	10
	2 elem. negro mate base madera	8201620-370*	55,58	10
	3 elem. negro mate base madera	8201630-370*	103,94	5
	4 elem. negro mate base madera	8201640-370*	139,06	5

(Haya 100% certificado PEFC)

COLECCIONES DE MECANISMOS

DESCRIPCIÓN	ARTÍCULO	PRECIO € Recomendado	PIEZAS CAJA
TITANIO			
 1 elem. titaniO base cromo	8201610-496*	19,65	10
2 elem. titaniO base cromo	8201620-496*	33,62	10
3 elem. titaniO base cromo	8201630-496*	47,34	5
4 elem. titaniO base cromo	8201640-496*	60,10	5

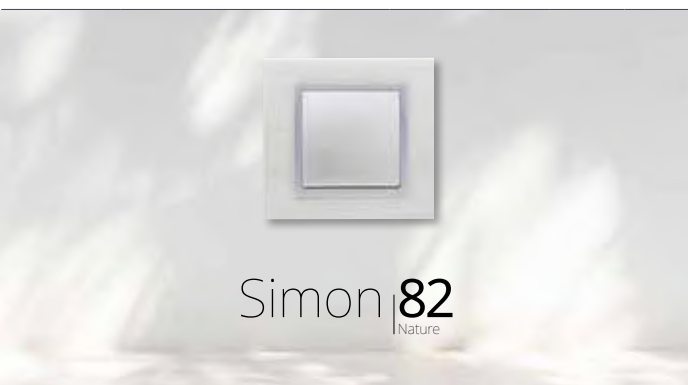

CAJAS DE SUPERFICIE			
Caja superficie Detail 82 1 elem. blanco	8200750-030	7,47	5
Caja superficie Detail 82 1 elem. marfil	8200750-031	7,47	5
Caja superficie Detail 82 1 elem. grafito	8200750-038	8,34	5
Caja superficie Detail 82 1 elem. aluminio	8200750-093	20,32	5
Caja superficie Detail 82 2 elem. blanco	8200760-030	13,09	5
Caja superficie Detail 82 2 elem. marfil	8200760-031	13,09	1
Caja superficie Detail 82 2 elem. grafito	8200760-038	13,85	1
Caja superficie Detail 82 2 elem. aluminio	8200760-093	35,60	1
Caja superficie Detail 82 3 elem. blanco	8200770-030	16,77	1
Caja superficie Detail 82 3 elem. marfil	8200770-031	16,77	1
Caja superficie Detail 82 3 elem. grafito	8200770-038	20,12	1
Caja superficie Detail 82 3 elem. aluminio	8200770-093	45,69	1



MARCOS

ACABADO CRISTAL			
 1 elemento cristal blanco	82617-30	39,97	1
2 elementos cristal blanco	82627-30	59,05	1
3 elementos cristal blanco	82637-30	91,49	1
4 elementos cristal blanco	82647-30	118,87	1
 1 elemento cristal natural	82617-60	29,56	1
2 elementos cristal natural	82627-60	41,83	1
3 elementos cristal natural	82637-60	68,40	1
4 elementos cristal natural	82647-60	88,87	1
 1 elemento cristal negro	82817-32	40,71	1
2 elementos cristal negro	82827-32	59,73	1
3 elementos cristal negro	82837-32	93,08	1
4 elementos cristal negro	82847-32	117,95	1
 1 elemento cristal cobre	82817-34	40,71	1
2 elementos cristal cobre	82827-34	59,73	1
3 elementos cristal cobre	82837-34	93,08	1
4 elementos cristal cobre	82847-34	117,95	1
 1 elemento cristal gris	82817-35	40,71	1
2 elementos cristal gris	82827-35	59,73	1
3 elementos cristal gris	82837-35	93,08	1
4 elementos cristal gris	82847-35	117,95	1
 1 elemento cristal plata	82917-62	40,71	1
2 elementos cristal plata	82927-62	59,73	1
3 elementos cristal plata	82937-62	93,08	1
4 elementos cristal plata	82947-62	117,95	1

DESCRIPCIÓN	ARTÍCULO	PRECIO € Recomendado	PIEZAS CAJA
ACABADO PIEDRA			
 1 elemento pizarra	82917-63	37,92	1
2 elementos pizarra	82927-63	55,99	1
3 elementos pizarra	82937-63	86,26	1
4 elementos pizarra	82947-63	112,13	1

ACABADO MADERA			
 1 elemento wengué	82917-65	39,55	1
2 elementos wengué	82927-65	58,45	1
3 elementos wengué	82937-65	88,38	1
4 elementos wengué	82947-65	117,07	1
 1 elemento roble	82917-66	39,55	1
2 elementos roble	82927-66	58,45	1
3 elementos roble	82937-66	88,38	1
4 elementos roble	82947-66	117,07	1

ACABADO METAL			
 1 elemento inox mate. Interior grafito	82817-31	38,68	1
2 elementos inox mate. Interior grafito	82827-31	54,75	1
3 elementos inox mate. Interior grafito	82837-31	86,97	1
4 elementos inox mate. Interior grafito	82847-31	113,05	1
 1 elemento inox mate. Interior aluminio	82917-34	38,68	1
2 elementos inox mate. Interior aluminio	82927-34	54,75	1
3 elementos inox mate. Interior aluminio	82937-34	86,97	1
4 elementos inox mate. Interior aluminio	82947-34	113,05	1
 1 elemento acero inox	82817-37	33,21	1
2 elementos acero inox	82827-37	46,99	1
3 elementos acero inox	82837-37	75,37	1
4 elementos acero inox	82847-37	97,94	1
 1 elemento plomo	82817-38	33,21	1
2 elementos plomo	82827-38	46,99	1
3 elementos plomo	82837-38	75,37	1
4 elementos plomo	82847-38	97,94	1
 1 elemento aluminio	82917-33	33,21	1
2 elementos aluminio	82927-33	46,99	1
3 elementos aluminio	82937-33	71,49	1
4 elementos aluminio	82947-33	92,90	1
 1 elemento inox negro	82917-38	38,68	1
2 elementos inox negro	82927-38	54,75	1
3 elementos inox negro	82937-38	86,97	1
4 elementos inox negro	82947-38	113,05	1

DESCRIPCIÓN

ARTÍCULO

PRECIO €
RecomendadoPIEZAS
CAJA

DESCRIPCIÓN



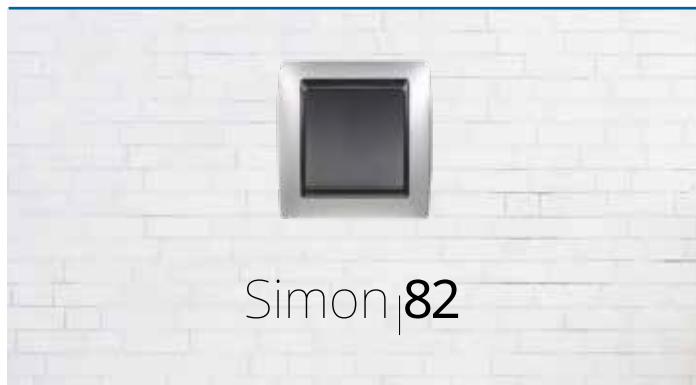

ARTÍCULO

PRECIO €
RecomendadoPIEZAS
CAJA



Simon 82

MARCOS





GAMA BLANCA

	1 elemento blanco	 82610-30	3,81	10
	2 elementos blanco	 82620-30	6,19	10
	3 elementos blanco	82630-30	11,57	10
	4 elementos blanco	82640-30	15,49	10
	1 elemento gris pastel	82611-33	5,90	10
	2 elementos gris pastel	82621-33	9,22	10
	3 elementos gris pastel	82631-33	17,52	5
	4 elementos gris pastel	82641-33	22,90	5



GAMA MARFIL

	1 elemento marfil	82710-31	4,02	10
	2 elementos marfil	82720-31	6,53	10
	3 elementos marfil	82730-31	11,90	10
	4 elementos marfil	82740-31	15,94	10
	1 elemento cava mate	82714-34	17,68	10
	2 elementos cava mate	82724-34	30,06	10
	3 elementos cava mate	82734-34	44,80	5
	4 elementos cava mate	82744-34	58,24	5

GAMA GRAFITO

	1 elemento grafito	82812-32	4,71	10
	2 elementos grafito	82822-32	7,66	10
	3 elementos grafito	82832-32	13,96	5
	4 elementos grafito	82842-32	18,71	5
	1 elemento aluminio mate	82814-33	17,54	10
	2 elementos aluminio mate	82824-33	30,28	10
	3 elementos aluminio mate	82834-33	45,83	5
	4 elementos aluminio mate	82844-33	59,04	5
	1 elemento cava mate	82814-34	17,90	10
	2 elementos cava mate	82824-34	30,86	10
	3 elementos cava mate	82834-34	46,10	5
	4 elementos cava mate	82844-34	59,34	5
	1 elemento cobre viejo	82814-36	21,64	10
	2 elementos cobre viejo	82824-36	37,76	10
	3 elementos cobre viejo	82834-36	52,55	5
	4 elementos cobre viejo	82844-36	67,16	5

GAMA METAL ALUMINIO Y CAVA

	1 elementos aluminio mate	82914-33	20,62	10
	2 elementos aluminio mate	82924-33	35,95	10
	3 elementos aluminio mate	82934-33	50,60	5
	4 elementos aluminio mate	82944-33	64,31	5
	1 elemento cava mate	82914-34	21,02	10
	2 elementos cava mate	82924-34	36,58	10
	3 elementos cava mate	82934-34	50,88	5
	4 elementos cava mate	82944-34	64,61	5

CAJAS DE SUPERFICIE

Caja de superficie baja 1 elemento	82750-30	8,10	10
	82750-31	8,33	10
	82750-38	8,77	10
Caja de superficie alta 1 elemento	82751-30	8,37	10
	82751-31	8,61	10
	82751-38	9,00	10
Caja de superficie baja 2 elementos	82760-30	13,84	5
	82760-31	14,24	5
	82760-38	14,97	5
Caja de superficie alta 2 elementos	82761-30	14,63	5
	82761-31	15,05	5
	82761-38	15,81	5
Caja de superficie alta 3 elementos	82771-30	18,76	5
	82771-31	19,30	5
	82771-38	21,76	5

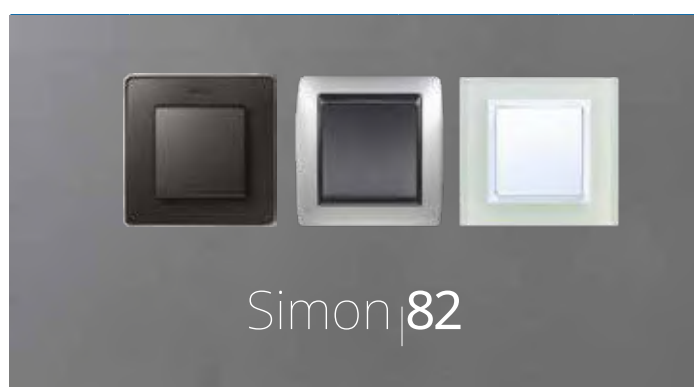

Simon 82

CONJUNTOS SEMI-MONTADOS
(MECANISMOS + TECLA / TAPA)

Interruptor unipolar 10 AX emb. rápido + tecla	8200101-030	11,18	10
	8200101-038	11,34	10
	8200101-093	12,01	10
Conmutador 10AX emb. rápido + tecla	8200201-030	12,52	10
	8200201-038	12,70	10
	8200201-093	13,44	10
Cruzamiento 10AX emb. rápido + tecla	8200251-030	22,42	5
	8200251-038	23,49	5
	8200251-093	23,87	5
Doble Conmutador 10AX emb. rápido + teclas	8200397-030	29,06	5
	8200397-038	29,18	5
	8200397-093	29,68	5
Doble Interruptor 10AX emb. rápido + teclas	8200398-030	23,43	5
	8200398-038	23,99	5
	8200398-093	24,41	5
Base de Enchufe 16A emb. tornillo + tapa	8200432-030	11,07	10
	8200432-038	11,17	10
	8200432-093	12,30	10

TECLAS Y TAPAS 82 DETAIL, 82, 82 NATURE

Placa v&d univ. plana c/g polvo para 1 RJ45	82005-30	12,30	5
	82005-31	13,03	5
	82005-33	16,28	5
	82005-34	16,37	5
	82005-38	13,30	5
	82005-93	14,26	5
Placa v&d univ. plana c/g polvo para 2 RJ45	82006-30	12,40	5
	82006-31	13,19	5
	82006-33	16,55	5
	82006-34	16,63	5
	82006-38	13,50	5
	82006-93	14,48	5

COLECCIONES DE MECANISMOS

DESCRIPCIÓN	ARTÍCULO	PRECIO € Recomendado	PIEZAS CAJA	DESCRIPCIÓN	ARTÍCULO	PRECIO € Recomendado	PIEZAS CAJA	
Tecla interruptores y conmutadores	82010-30	4,22	20	Tecla interruptor bipolar 16 A	82031-30	5,39	5	
	82010-31	4,34	20		82031-31	5,55	5	
	82010-33	5,42	20		82031-33	7,43	5	
	82010-34	5,44	20		82031-34	7,48	5	
	82010-38	4,63	20		82031-38	5,88	5	
	82010-93	4,77	20		82031-93	6,48	5	
Tecla int. y conmutadores con luminoso	82011-30	5,41	20	Tecla interruptor persianas 3 posiciones	82033-30	6,82	10	
	82011-31	5,62	20		82033-31	7,08	10	
	82011-33	7,79	20		82033-33	9,35	10	
	82011-34	7,84	20		82033-34	9,38	10	
	82011-38	6,15	20		82033-38	7,57	10	
	82011-93	6,72	20		82033-93	8,18	10	
Tecla pulsador neutral	82013-30	5,05	5	Tapa + disco, gama tacto	82034-30	7,53	5	
	82013-31	5,19	5		82034-31	7,75	5	
	82013-33	6,99	5		82034-33	10,69	5	
	82013-34	7,03	5		82034-38	7,98	5	
	82013-38	5,50	5		82034-93	9,80	5	
	82013-93	6,14	5		Tapa + botón, regulador electrón. 1.000W	82035-30	19,01	5
Tecla pulsador campana con luminoso	82015-30	5,68	5	82035-31		19,55	5	
	82015-31	5,85	5	82035-38		22,64	5	
	82015-33	8,03	5	Tapa baliza cortesía basculante	82036-30	11,61	5	
82015-34	8,05	5	82036-31		12,05	5		
82015-38	6,28	5	82036-33		14,00	5		
Tecla pulsador luz luminoso	82015-93	7,18	5	82036-34	14,09	5		
	Tecla pulsador luz luminoso	82016-30	5,74	10	82036-38	12,33	5	
		82016-31	5,96	10	82036-93	12,26	5	
		82016-33	8,18	5	Tapa enchufe 2P + seguridad	82040-30	5,46	10
		82016-34	8,20	5		82040-31	5,62	10
82016-38		6,39	5	82040-33		7,79	10	
Tecla pulsador campana	82016-93	7,18	5	82040-34	7,85	10		
	82017-30	5,02	10	82040-38	5,95	10		
	82017-31	5,16	10	82040-64	7,41	10		
	82017-33	6,52	10	82040-93	6,81	10		
	82017-34	6,56	10	Tapa enchufe 2P + TT lateral schuko + seguridad	82041-30	4,84	10	
82017-38	5,52	10	82041-31		4,98	10		
82017-93	5,73	10	82041-33		7,31	10		
Tecla pulsador luz	82018-30	5,07	5		82041-34	7,34	10	
	82018-31	5,26	5		82041-37	5,61	10	
	82018-33	6,64	5	82041-38	5,50	10		
	82018-34	6,69	5	82041-64	7,27	10		
	82018-38	5,62	5	82041-93	6,53	10		
Tecla grupo 2 pulsadores o conmut. con luminoso	82018-93	5,84	5	Tapa para base enchufe británica	82045-30	4,82	10	
	82025-30	9,56	5		82045-31	5,01	10	
	82025-31	9,92	5		82045-33	7,05	10	
	82025-33	14,81	5		82045-34	7,05	10	
	82025-34	14,87	5		82045-38	5,30	10	
	82025-38	12,41	5		82045-93	6,23	5	
Tecla grupo 2 int., conmutadores o pulsadores	82025-93	12,50	5	Tapa salida de cables	82051-30	5,76	10	
	82026-30	5,93	20		82051-31	5,98	10	
	82026-31	6,10	20		82051-33	8,11	10	
	82026-33	7,90	20		82051-34	8,17	10	
	82026-34	7,94	20		82051-38	6,41	10	
	82026-38	6,45	20		82051-93	7,09	10	
Tecla grupo 1 conmutador + 1 pulsador	82026-93	6,93	20	Tapa zumbador o altavoz 2" 05562-39	82052-30	6,16	5	
	82027-30	6,12	5		82052-31	6,39	5	
	82027-31	6,30	5		82052-33	9,07	5	
	82027-33	8,37	5		82052-38	6,87	5	
	82027-34	8,40	5		82052-93	7,96	5	
	82027-38	6,55	5		Tapa toma R-TV	82053-30	5,20	20
82027-93	7,31	5	82053-31	5,52		20		
Tecla persianas, con enclavamiento	82028-30	6,44	20	82053-33		6,95	20	
	82028-31	6,69	20	82053-34		7,01	20	
	82028-33	9,18	20	82053-38		5,60	20	
	82028-34	9,22	20	82053-93		6,11	20	
	82028-38	7,18	20	Tapa+boton, regulador electrónico 500 W	82054-30	8,60	5	
	82028-93	8,04	20		82054-31	8,84	5	
Tecla persianas, sin enclavamiento	82029-30	6,75	5		82054-33	11,82	5	
	82029-31	6,95	5		82054-34	11,86	5	
	82029-33	9,23	5		82054-38	9,24	5	
	82029-34	9,27	5		82054-93	10,33	5	
	82029-38	7,14	5					
	82029-93	8,49	5					

DESCRIPCIÓN	ARTÍCULO	PRECIO € Recomendado	PIEZAS CAJA	DESCRIPCIÓN	ARTÍCULO	PRECIO € Recomendado	PIEZAS CAJA	
Tapa para detector de presencia 75343-39	82060-30	4,81	5	Adaptador universal 1 conector	82578-30	14,21	5	
	82060-31	4,95	5		82578-31	14,62	5	
	82060-33	7,41	5		82578-38	15,26	5	
	82060-34	7,44	5		Adaptador universal 2 conectores	82579-30	15,59	5
	82060-38	5,22	5			82579-31	16,04	5
	82060-93	6,46	5	82579-38	16,76	5		
Tapa difusor verde	82065-30	4,67	5	Placa ciega	82800-30	9,24	10	
Tapa difusor translúcido	82065-31	4,81	5		82800-31	9,51	10	
Tapa difusor rojo	82065-32	4,67	5		82800-33	11,81	10	
Tapa enchufe 2P+TT francesa+seguridad	82068-30	5,83	10		82800-34	11,87	10	
	82068-31	6,00	10	82800-38	9,74	10		
	82068-33	8,23	10	82800-93	10,25	10		
	82068-34	8,25	10	Filtros colores, baliza cortesia basculante	82960-39	7,79	1	
	82068-38	6,10	10		Tecla con visor para Simon 77	8200011-030	5,36	20
		82068-64	8,03	10	8200011-031	5,52	20	
Tapa conmutador tarjeta hotel temporizado	82078-60	11,57	5	8200011-033	7,48	20		
	82078-61	11,90	5	8200011-034	7,48	20		
	82078-63	13,59	5	8200011-038	5,87	20		
	82078-64	13,59	5	8200011-093	6,55	20		
	82078-68	11,73	5	Tecla con visor neutro para Simon 77	8200013-030	5,10	5	
	82078-93	11,89	5		8200013-031	5,25	5	
Tapa + botón, conmutador rotativo 4 posiciones	82079-30	9,09	5	8200013-033	7,06	5		
	82079-31	9,36	5	8200013-034	7,06	5		
	82079-38	9,74	5	8200013-038	5,51	5		
	82079-93	9,88	5	8200013-093	6,17	5		
Tapa gama IR	82080-30	5,36	5	Tecla con visor campana para Simon 77	8200015-030	5,72	5	
	82080-31	5,52	5		8200015-031	5,89	5	
	82080-33	8,14	5	8200015-033	7,90	5		
	82080-34	8,16	5	8200015-034	7,90	5		
	82080-38	5,83	5	8200015-038	6,16	5		
	82080-93	7,12	5	8200015-093	6,92	5		
Tapa toma altavoces	82082-30	5,91	5	Tecla con visor luz para Simon 77	8200016-030	5,72	10	
	82082-31	6,08	5		8200016-031	5,89	10	
	82082-33	8,82	5	8200016-033	7,90	5		
	82082-34	8,87	5	8200016-034	7,90	5		
	82082-38	6,32	5	8200016-038	6,16	5		
				8200016-093	6,92	5		
Adaptador elementos 45x45 mm.	82088-30	6,14	10	Tapa para base enchufe británica int. Detail 82	8200046-030	5,14	5	
	82088-31	6,37	10		8200046-031	5,24	5	
	82088-33	7,91	10	8200046-033	7,49	5		
	82088-34	7,96	10	8200046-038	5,67	5		
	82088-38	6,86	10	8200046-093	6,83	5		
	82088-93	6,67	10	Tapa para base de enchufe schuko con 2 bocas carga USB 2.1A tipo A	8200049-030	6,12	5	
Tapa articulada enchufe 2P + TT schuko + seg.	82090-30	14,65	10		8200049-031	6,30	5	
	82090-31	15,07	10		8200049-033	8,24	5	
	82090-33	18,57	10		8200049-034	8,24	5	
	82090-38	15,82	10	8200049-038	6,47	5		
82090-93	16,91	10	8200049-093	7,47	5			
Tapa difusor bicolor	82096-30	53,99	1	Tapa mecanismo con llave	8200057-030	5,92	5	
	82096-31	56,04	1		8200057-031	6,09	5	
	82096-33	57,80	1	8200057-033	8,76	5		
	82096-34	58,08	1	8200057-034	8,79	5		
	82096-38	57,39	1	8200057-038	6,33	5		
	82096-93	50,60	1	8200057-093	7,67	5		
Tapa toma R-TV+SAT	82097-30	5,52	20	Tapa visor conmutador tarjeta hotel	8200078-060	10,57	5	
	82097-31	5,68	20		8200078-061	10,88	5	
	82097-33	7,14	20		8200078-063	13,59	5	
	82097-34	7,17	20		8200078-064	13,83	5	
	82097-38	5,91	20	8200078-068	11,57	5		
	82097-93	6,27	20	8200078-093	12,13	5		
Tapa termostato empotrar	82505-30	5,89	5	Tapa para base de enchufe afeitadora	8200089-030	6,80	1	
	82505-31	6,06	5		8200089-038	7,43	1	
	82505-33	11,77	5	Tapa conector VGA + mini-jack	8200091-030	4,53	1	
	82505-34	11,82	5		8200091-031	4,66	1	
	82505-38	10,43	5		8200091-033	6,40	1	
	82505-93	10,48	5		8200091-034	6,49	1	
			8200091-038	4,81	1			
			8200091-093	6,11	1			

COLECCIONES DE MECANISMOS

SERIES SUPERFICIE Y EMPOTRAR

DESCRIPCIÓN	ARTÍCULO	PRECIO € Recomendado	PIEZAS CAJA
Tapa conector VGA + 3RCA	8200092-030	4,62	1
	8200092-031	4,75	1
	8200092-033	6,23	1
	8200092-034	6,31	1
	8200092-038	4,90	1
	8200092-093	5,94	1
Base de enchufe toma afeitadora 3mod.	8200482-030	141,94	1
	8200482-038	153,25	1
Tapa conector fibra óptica	8200545-030	13,66	5
	8200545-031	14,89	5
	8200545-033	18,62	5
	8200545-034	17,16	5
	8200545-038	16,19	5
	8200545-093	16,00	5
Tapa conector 2xUSB 2.0 tipo A	8201090-030	4,55	1
	8201090-031	4,72	1
	8201090-033	6,41	1
	8201090-034	6,41	1
	8201090-038	5,02	1
	8201090-093	6,01	1
Tapa conector mini-jack + 2RCA	8201092-030	4,81	1
	8201092-031	4,94	1
	8201092-033	6,49	1
	8201092-034	6,49	1
	8201092-038	5,11	1
	8201092-093	6,12	1
Tapa conector HDMI v1.4	8201094-030	4,37	1
	8201094-031	4,54	1
	8201094-033	6,12	1
	8201094-034	6,12	1
	8201094-038	4,81	1
	8201094-093	5,74	1
Tapa conector HDMI v1.4 + USB 2.0 tipo A Detail 82	8201095-030	4,55	1
	8201095-031	4,72	1
	8201095-033	6,41	1
	8201095-034	6,41	1
	8201095-038	5,02	1
	8201095-093	6,01	1
Placa cargador 2xUSB 5V 2.1A	8221096-030	4,61	1
	8221096-031	4,75	1
	8221096-033	6,22	1
	8221096-034	6,22	1
	8221096-038	4,88	1
	8221096-093	5,63	1
Tecla doble para luminoso azul	8202025-030	9,33	5
Tecla doble para luminoso azul	8202025-031	9,68	5
Tecla doble para luminoso azul	8202025-033	8,20	5
Tecla doble para luminoso azul	8202025-034	8,25	5
Tecla doble para luminoso azul	8202025-038	12,17	5
Tecla doble para luminoso azul	8202025-093	13,75	5
Tecla doble para cruzamiento doble	8202026-030	6,00	5
	8202026-031	6,17	5
	8202026-033	7,97	5
	8202026-034	8,03	5
	8202026-038	6,53	5
	8202026-093	7,35	5
Placa Doble Cargador USB C+A QuickCharge	8201296-030	5,15	1
	8201296-031	5,30	1
	8201296-033	6,94	1
	8201296-034	6,94	1
	8201296-038	5,45	1
	8201296-093	5,24	1



MECANISMOS, TECLAS Y TAPAS

DESCRIPCIÓN	ARTÍCULO	PRECIO € Recomendado	PIEZAS CAJA
Enlazadores eléctricos para enchufes	27996-39	3,40	20
Interruptor bipolar 16 A con piloto	75134-69	19,05	5
Pulsador 10 A	75150-69	10,23	10
Conmutador 16A	75211-69	11,03	10
Conmutador cruce 16A	75253-69	23,59	5
Grupo 2 pulsadores para persianas	75396-69	19,82	5
Enchufe 2P+TT lateral schuko + seguridad	75432-69	7,01	10
Enchufe 2P + TT lateral schuko emb. rápido	75464-69	7,08	10
SopORTE neon para mecanismos	75802-31	10,83	10
Cargador USB 5Vdc 2.1A tipo smartcharge	8201097-060	48,03	1
	8201097-061	49,39	1
	8201097-063	50,76	1
	8201097-064	50,76	1
	8201097-068	48,49	1



TECLAS Y TAPAS

DESCRIPCIÓN	ARTÍCULO	PRECIO € Recomendado	PIEZAS CAJA
Tecla interruptores y conmutadores	88010-30	6,48	20
	88010-32	6,95	20
	88010-38	6,95	20
Tecla int. y conmutadores con luminoso	88011-30	6,69	20
	88011-32	7,17	20
	88011-38	7,17	20
Tecla int. y conmutadores con piloto	88012-30	7,17	20
	88012-32	7,36	20
	88012-38	7,36	20
Tecla pulsador campana con luminoso	88015-30	6,88	20
	88015-32	7,44	20
	88015-38	7,44	20
Tecla pulsador luz con luminoso	88016-30	6,88	20
	88016-32	7,44	20
	88016-38	7,44	20
Tecla pulsador campana	88017-30	6,75	20
	88017-32	7,22	20
	88017-38	7,22	20
Tecla pulsador luz	88018-30	6,85	20
	88018-32	7,37	20
	88018-38	7,37	20

DESCRIPCIÓN	ARTÍCULO	PRECIO € Recomendado	PIEZAS CAJA
Tecla grupo 2 int., conmutadores o pulsadores	88026-30	8,27	20
	88026-32	8,97	20
	88026-38	8,97	20
Tecla grupo 1 conmutadores + 1 pulsador	88027-30	8,51	20
	88027-32	9,16	20
	88027-38	9,16	20
Tecla persianas con enclavamiento	88028-30	8,68	20
	88028-32	9,26	20
	88028-38	9,26	20
Tecla persianas sin enclavamiento	88029-30	9,20	20
	88029-32	9,82	20
	88029-38	9,82	20
Tecla interruptor bipolar 16A	88031-30	7,44	20
	88031-32	8,02	20
	88031-38	8,02	20
Tecla interruptor bipolar 16A con piloto	88032-30	7,17	20
	88032-32	7,65	20
	88032-38	7,65	20
Tecla interruptor 3 posiciones	88033-30	8,89	10
	88033-32	12,27	5
	88033-38	12,27	5
Tapa + disco, gama tacto	88034-30	11,44	10
	88034-32	15,56	10
	88034-38	15,56	10
Tapa enchufe 2P + seguridad	88040-60	8,09	10
	88040-62	8,51	10
	88040-68	8,51	10
Tapa enchufe 2P + TT lateral schuko + seguridad	88041-60	8,09	10
	88041-62	8,51	10
	88041-68	9,27	10
Tapa zumbador o altavoz 2" 05562-39	88052-30	7,07	10
	88052-32	7,61	10
	88052-38	7,61	10
Tapa toma R-TV	88053-30	7,12	10
	88053-32	7,64	10
	88053-38	7,64	10
Tapa + botón, regulador electrónico 500 W	88054-30	11,96	10
	88054-32	12,85	10
	88054-38	12,85	10
Tapa toma teléfono	88062-30	7,30	10
	88062-32	7,81	10
	88062-38	7,81	10
Tecla int. o conmutadores portarótulos	88063-30	7,62	20
	88063-32	8,30	20
	88063-38	8,30	20
Tapa difusor verde	88065-30	5,94	10
	88065-31	5,94	10
	88065-32	5,98	10
Tapa enchufe 2P + TT francés + seguridad	88068-60	6,88	10
	88068-62	7,36	10
	88068-68	7,36	10
Tapa int.-conmutador tarjeta	88078-30	15,86	10
	88078-32	17,10	10
	88078-38	17,10	10
Tapa gama IR	88080-30	3,74	10
	88080-32	3,94	10
	88080-38	3,94	10
Adaptador universal 1 conector	88081-30	17,85	10
	88081-38	18,70	10
	88082-30	7,62	10
Tapa toma altavoz estéreo	88082-32	8,30	10
	88082-38	8,30	10
	88086-30	18,84	10
Adaptador acodado 2 conectores	88086-38	19,68	10
	88088-30	7,55	10
	88088-32	7,66	10
Adaptador elementos 45x45 mm	88088-38	7,66	10

DESCRIPCIÓN	ARTÍCULO	PRECIO € Recomendado	PIEZAS CAJA
Tapa toma R-TV + SAT	88097-30	7,30	10
	88097-32	7,79	10
	88097-38	7,79	10
Tapa conector fibra óptica	88545-30	17,84	5
	88545-38	18,69	5
Tapa ciega	88800-30	11,68	10
	88800-32	12,56	10
	88800-38	12,56	10

MARCOS

REDONDOS

	1 elemento redondo blanco	88610-30	4,56	10
	2 elementos redondo blanco	88620-30	6,93	10
	3 elementos redondo blanco	88630-30	12,53	10
	4 elementos redondo blanco	88640-30	19,98	1
	1 elemento redondo cromada	88610-33	28,20	1
	2 elementos redondo cromado	88620-33	45,36	1
	3 elementos redondo cromado	88630-33	61,34	1
	1 elemento redondo acero	88610-35	28,66	1
	2 elementos redondo acero	88620-35	47,11	1
	3 elementos redondo acero	88630-35	63,05	1
	1 elemento redondo oro	88610-36	31,96	1
	2 elementos redondo oro	88620-36	54,74	1
	3 elementos redondo oro	88630-36	72,55	1
	1 elemento redondo grafito	88610-38	4,87	10
	2 elementos redondo grafito	88620-38	7,30	10
	3 elementos redondo grafito	88630-38	13,20	10

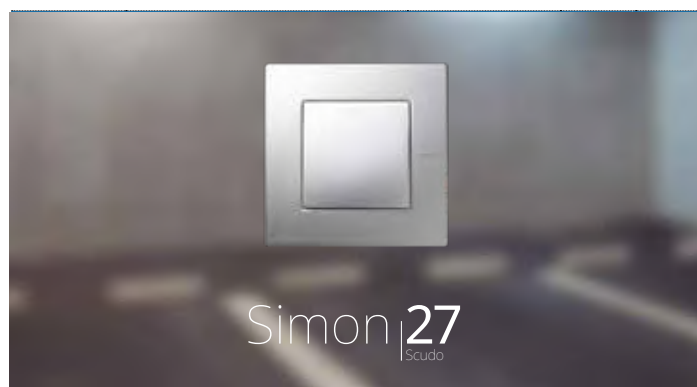





TECLAS Y TAPAS

Tecla blanca	2705010-030	5,29	10
Tecla top impact	2705010-033	17,04	5
Tecla gris esmeril	2705010-063	5,29	10
Tecla con visor blanca	2705011-030	5,95	5
Tecla con visor top impact	2705011-033	17,95	5
Tecla con visor gris esmeril	2705011-063	5,86	5
Tecla doble blanca	2705026-030	8,16	5
Tecla doble gris esmeril	2705026-063	8,28	5
Tapa para baliza	2705036-096	4,85	5
Tapa para baliza	2705036-102	4,85	5
Tapa para baliza	2705036-108	4,85	5
Tapa de enchufe blanca	2705041-030	3,43	10
Tapa de enchufe gris esmeril	2705041-063	3,48	10
Tapa toma teléfono blanca	2705062-030	3,39	5
Tapa para toma teléfono gris esmeril	2705062-063	3,51	5
Adaptador serie 27 blanco	2705088-030	7,56	5

COLECCIONES DE MECANISMOS

SERIES SUPERFICIE Y EMPOTRAR

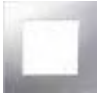
DESCRIPCIÓN	ARTÍCULO	PRECIO € Recomendado	PIEZAS CAJA
Adaptador serie 27 gris esmeril	2705088-063	7,85	5
Tapa con llave blanca	2705091-030	16,51	5
Tapa con llave top impact	2705091-033	29,33	5
Tapa con llave gris esmeril	2705091-063	17,14	5
Tapa articulada blanca	2705092-030	9,57	5
Tapa articulada top impact	2705092-033	24,32	5
Tapa articulada gris esmeril	2705092-063	9,93	5
Tapa para toma R-TV/SAT blanca	2705097-030	4,62	5
Tapa para toma R-TV/SAT gris esmeril	2705097-063	4,78	5
Juego de 2 llaves	2705891-039	11,72	5
Junta estanca IP44	2705950-030	4,93	5

MARCOS			
	1 elemento blanco (*)	2705610-030	9,56 10
	2 elementos blanco (*)	2705620-030	18,26 5
	3 elementos blanco (*)	2705630-030	31,67 5
	1 elemento top impact (*)	2705610-033	29,71 5
	2 elementos top impact (*)	2705620-033	54,85 1
	1 elemento gris esmeril (*)	2705610-063	9,56 10
	2 elementos gris esmeril (*)	2705620-063	18,26 5
	3 elementos gris esmeril (*)	2705630-063	32,12 5
	1 elemento cromado (*)	2705610-124	11,47 10
	2 elementos cromado (*)	2705620-124	21,86 5
	3 elementos cromado (*)	2705630-124	40,04 5

(*) Se suministra con una llave tipo Allen.



MONOBLOCK SUPERFICIE IP55 (COLORES: -035 GRIS / -030 BLANCO)

Pulsador IP55	4490150-035	13,26	10
Pulsador con luminoso IP55	4490160-035	20,94	10
Conmutador IP55	4490201-035	11,82	10
Conmutador con luminoso IP55	4490204-035	21,21	10
Base enchufe 2P con TT lateral schuko	4490432-035	15,27	10
Doble base enchufe 2P con TT lateral schuko, precableada	4490433-035	34,30	5
Conmutador 10AX 250V con piloto IP55	4490202-035	22,27	10
Base enchufe schuko con T.T. lateral 16A 250V emb. tornillo	4490472-035	15,27	10
Doble base enchufe schuko con T.T. lateral 16A 250V emb. tornillo precableada	4490473-035	34,30	5
Pulsador 10AX 250V	4490150-030	15,26	10
Pulsador 10AX 250V con luminoso	4490160-030	24,08	10
Conmutador 10AX 250V	4490201-030	13,60	10
Conmutador 10AX 250V con luminoso	4490204-030	24,39	10
Conmutador 10AX 250V con piloto	4490202-030	25,62	10

DESCRIPCIÓN	ARTÍCULO	PRECIO € Recomendado	PIEZAS CAJA
Base enchufe schuko con T.T. lateral 16A 250V emb. tornillo	4490472-030	17,57	10
Doble base enchufe schuko con T.T. lateral 16A 250V emb. tornillo precableada	4490473-030	39,46	5

MONOBLOCK EMPOTRAR IP55

Conmutador 10AX 250V gris	4499201-035	15,37	5
Pulsador 10AX 250V gris	4499150-035	17,24	5
Base enchufe schuko con T.T. lateral 10/16A 250V emb. tornillo gris	4499472-035	19,84	5
Doble base enchufe schuko con T.T. lateral 10/16A 250V emb. tornillo gris	4499473-035	44,58	5
Conmutador 10AX 250V blanco	4499201-030	16,91	5
Pulsador 10AX 250V blanco	4499150-030	18,97	5
Base enchufe schuko con T.T. lateral 10/16A 250V emb. tornillo blanco	4499472-030	21,82	5
Doble base enchufe schuko con T.T. lateral 10/16A 250V emb. tornillo blanco	4499473-030	49,04	5

CAJAS DE SUPERFICIE

Base estanca 1 elemento gris	4400751-035	4,89	10
Base estanca 2 elementos horizontal gris	4400761-035	15,97	5
Base estanca 2 elementos vertical gris	4400763-035	15,97	5
Base estanca 3 elementos gris	4400765-035	24,98	5
Base estanca 1 elemento blanco	4400751-030	5,12	10
Base estanca 2 elementos horizontal blanco	4400761-030	17,83	5
Base estanca 2 elementos vertical blanco	4400763-030	17,83	5
Base estanca 3 elementos blanco	4400765-030	27,90	5

MARCOS DE EMPOTRAR

Marco 1 elemento empotrar gris	4400610-035	8,32	5
Marco 2 elemento empotrar gris	4400620-035	21,45	5
Marco 3 elemento empotrar gris	4400630-035	28,56	5
Marco 1 elemento empotrar blanco	4400610-030	9,99	5
Marco 2 elemento empotrar blanco	4400620-030	23,18	5
Marco 3 elemento empotrar blanco	4400630-030	34,28	5

COMPONIBLES (FUNCIÓN + TECLA/TAPA)

Conmutador 10AX IP55 gris	4400201-035	10,00	10
Conmutador 10AX luminoso gris	4400204-035	19,41	5
Conmutador 10AX piloto IP55 gris	4400202-035	19,61	5
Cruzamiento 10AX IP55 gris	4400251-035	19,01	5
Doble conmutador 10AX IP55 gris	4400397-035	19,88	5
Doble conmutador 10AX luminoso IP55 gris	4400394-035	36,75	5
Pulsador 10AX IP55 gris	4400150-035	10,55	5
Pulsador 10AX luminoso IP55 gris	4400160-035	18,89	5
Base schuko 16AX emb. tornillo IP55 gris	4400472-035	11,73	10
Base schuko 16AX emb. rápido IP55 gris	4400432-035	11,73	10
Toma TV única IP55 gris	4400466-035	27,35	5
Toma TV intermedia IP55 gris	4400467-035	27,35	5
Toma TV final IP55 gris	4400468-035	27,35	5
Conmutador 10AX IP55 blanco	4400201-030	10,50	10
Conmutador 10AX luminoso blanco	4400204-030	20,39	5
Conmutador 10AX piloto IP55 blanco	4400202-030	20,60	5
Cruzamiento 10AX IP55 blanco	4400251-030	19,96	5
Doble conmutador 10AX IP55 blanco	4400397-030	20,88	5
Doble conmutador 10AX luminoso IP55 blanco	4400394-030	38,58	5
Pulsador 10AX IP55 blanco	4400150-030	11,09	5
Pulsador 10AX luminoso IP55 blanco	4400160-030	19,83	5
Base schuko 16AX emb. tornillo IP55 blanco	4400472-030	12,33	10
Base schuko 16AX emb. rápido IP55 blanco	4400432-030	12,33	10

DESCRIPCIÓN	ARTÍCULO	PRECIO € Recomendado	PIEZAS CAJA	DESCRIPCIÓN	ARTÍCULO	PRECIO € Recomendado	PIEZAS CAJA
Toma TV única IP55 blanco	4400466-030	28,74	5				
Toma TV intermedia IP55 blanco	4400467-030	28,74	5				
Toma TV final IP55 blanco	4400468-030	28,74	5				

**OTROS ARTÍCULOS
(COLORES: -033 ALUMINIO / -065 VERDE PISTACHO / -037 ROJO)**

Tecla doble aluminio	4400026-033	6,22	5
Tecla doble rojo	4400026-037	3,33	5
Tecla doble verde pistacho	4400026-065	3,33	5
Marco sin tapa	4400088-035	5,23	5

MARCOS ADAPTADORES (PARA FUNCIONES SIMON | 27)

Marco con tecla simple gris	4400010-035	5,41	10
Marco con tecla doble gris	4400026-035	9,83	5
Marco con cubierta translúcida gris	4400036-102	7,21	5
Marco con tapa articulada gris	4400092-035	6,29	10
Marco con tecla simple blanco	4400010-030	6,22	10
Marco con tecla doble blanco	4400026-030	11,29	5
Marco con cubierta translúcida blanco	4400036-100	8,28	5
Marco con tapa articulada blanco	4400092-030	7,25	10

CAJA COMPLETA SIN MECANISMO (COLORES: -35 GRIS)

Caja vacía IP40	4490780-035	5,73	10
-----------------	-------------	------	----

OTROS

Marco con tapa empotrar 1 elemento	44519-38	17,79	10
Marco con tapa empotrar 2 elementos	44529-38	36,32	5
Pulsador campana empotrar	44570-38	23,14	10

COLECCIONES DE MECANISMOS

SUMINISTRO PALET COMPLETO

DESCRIPCIÓN

ARTÍCULO PRECIO € PIEZAS
Recomendado CAJA

DESCRIPCIÓN

ARTÍCULO PRECIO € PIEZAS
Recomendado CAJA

RELACIÓN DE ARTÍCULOS Y CANTIDADES CON POSIBILIDAD DE SUMINISTRO EN PALET COMPLETO

	Simon 27		Simon 31		Simon 75		Simon 77		Simon 82		500 Cima	
	Artículo	Unidades Palet	Artículo	Unidades Palet	Artículo	Unidades Palet	Artículo	Unidades Palet	Artículo	Unidades Palet	Artículo	Unidades Palet
Teclas					75010-30	4000			82010-30	4000		
					75041-60	2000			82041-30	2000		
									82041-33	2000		
									82041-38	2000		
Mecanismos	27101-65	4000	31101-30	2000	75101-39	2000	7700101-039	2000				
	27201-65	4000	31201-30	2000	75201-39	2000	7700201-039	2000				
					75397-39	2000						
Bases de enchufe	27432-62	4000	31432-60	2000	75432-39	2000					50010432-030	1440
	27432-65	4000	31432-61	2000							50010432-037	1440
	27472-62	4000										
	27472-65	4000										
Marcos	2700610-030	3000	31611-30	3000	75610-30	4000			82610-30	4000		
	2700610-031	3000										
	2700620-030	1500	31621-30	1500	75620-30	2400			82620-30	2400		
	2700620-031	1500										
	2700630-030	1500										
Piezas intermedias					75900-39	4000						
Cajas			31710-61	3000							51000003-030	150
			31712-61	2400							51020103-039	320

DESCRIPCIÓN

ARTÍCULO PRECIO €
 Recomendado PIEZAS
 CAJA

DESCRIPCIÓN

ARTÍCULO PRECIO €
 Recomendado PIEZAS
 CAJA

SUMINISTRO PALET COMPLETO

SISTEMAS DE CONTROL

SISTEMAS DE CONTROL

DESCRIPCIÓN ARTÍCULO PRECIO € PIEZAS
Recomendado CAJA



SENSE KEYPAD

Sense Keypad 1B Regular	8000611-030	74,75	1
	8000611-038	74,75	1
	8000611-093	74,75	1
Sense Keypad 2B Regular	8000621-030	87,43	1
	8000621-038	87,43	1
	8000621-093	87,43	1
	8000621-090	87,43	1
	8000621-098	87,43	1
	8000621-096	87,43	1
Sense Keypad 4B Regular	8000641-030	97,85	1
	8000641-038	97,85	1
	8000641-093	97,85	1
	8000641-090	97,85	1
	8000641-098	97,85	1
	8000641-096	97,85	1
Sense Keypad 6B Regular	8000661-030	107,00	1
	8000661-038	107,00	1
	8000661-093	107,00	1
	8000661-090	107,00	1
	8000661-098	107,00	1
	8000661-096	107,00	1

ACOPLADORES DE BUS

Acoplador de BUS Sense LON	8000100-039	93,07	1
Acoplador de BUS Sense KNX	8400100-039	84,94	1
Acoplador de BUS Scena	8900150-039	82,46	1

ACCESORIOS

Slide Control	8000700-030	67,45	1
	8000700-038	67,45	1
	8000700-093	67,45	1
Cable RJ-12 para Slide Control	8000701-039	3,82	1

SENSE & SLIDE KEYPAD LONWORKS®

Sense&Slide Keypad 4B Regular Incluye acoplador de BUS LON	8000651-030	268,69	1
	8000651-038	268,69	1
	8000651-093	268,69	1
Sense&Slide Keypad 6B Regular Incluye acoplador de BUS LON	8000671-030	272,59	1
	8000671-038	272,59	1
	8000671-093	272,59	1

SENSE & SLIDE KEYPAD KNX

Sense&Slide Keypad 4B Regular Incluye acoplador de BUS KNX	8400651-030	259,89	1
	8400651-038	259,89	1
	8400651-093	259,89	1
Sense&Slide Keypad 6B Regular Incluye acoplador de BUS KNX	8400671-030	263,68	1
	8400671-038	263,68	1
	8400671-093	263,68	1

DESCRIPCIÓN ARTÍCULO PRECIO € PIEZAS
Recomendado CAJA



CONTROL DE ILUMINACIÓN

MÓDULOS DE CONTROL

Touch LightManager Advance	89000110-030	1257,93	1
	89000110-038	1257,93	1
Acoplador de Bus Scena. Compatible con Sistema Sense	8900150-039	82,46	1
Touch LightKeypad	89000150-030	189,21	1
	89000150-038	189,21	1
Touch LightKeypad (serigrafía 8 dígitos)	89000151-030	189,21	1
	89000151-038	189,21	1
Touch LightKeypad (serigrafía 4 canales/4 escenas)	89000152-030	189,21	1
	89000152-038	189,21	1

MÓDULOS DE REGULACIÓN

Módulo Regulador Transformador Electrónico	89000200-039	158,57	1
Módulo Interruptor / Conmutador Electrónico	89000201-039	158,57	1
Módulo Regulador 1-10V	89000202-039	158,57	1
Módulo Control Persianas	89000203-039	169,12	1
Módulo regulador LED 3h	89000204-039	158,57	1
Módulo Control DALI	89000500-039	628,96	1

CONVERSORES

Convertor 3 canales DMX/DALI	89000300-039	628,96	1
Convertor Señales Digitales	89000301-039	126,85	1
Convertor Señales Analógicas	89000302-039	142,70	1
Convertor DMX/PWM RGBW	89000305-039	158,57	1
Convertor DMX/PWM RGB	89000303-039	158,57	1
Convertor DMX/PWM 1 canal	89000304-039	158,57	1

AMPLIFICADORES

Amplificador PWM 1 Canal	89000310-039	158,57	1
Amplificador PWM 4 Canales	89000311-039	158,57	1

SENSOR

Sensor CLC DALI standalone	89000401-039	184,99	1
----------------------------	--------------	--------	---

CAJA DE EMPOTRAR

Caja de empotrar Pantalla Touch Light Manager	89000990-039	11,63	1
---	--------------	-------	---

DESCRIPCIÓN

ARTÍCULO PRECIO € PIEZAS CAJA
Recomendado



Fuente de alimentación 12 vDC 2A 8999901-039 64,78 1

DESCRIPCIÓN

ARTÍCULO PRECIO € PIEZAS CAJA
Recomendado



CAJA METÁLICA

Caja Met 2 schuko y protección combi	0602102-039	344,88	1
Caja 2 schuko llaves, med. energ. Modbus	0602142-039	520,05	1
Caja 2 Schuko Rear, Sobret, Combi 16A	0602212-039	684,28	1

SIMON NEON STREET

PUNTO DE RECARGA COLUMNA

2x Base T2 7,4 kW - Max. 14,8 kW Monofásico	0620231-100	3735,73	1
2x Base T2 7,4 kW - Max. 14,8 kW Monofásico + Modem	0621231-100	3952,26	1
2x Base T2 7,4 kW - Max. 14,8 kW Monofásico + Modem + Diferencial autorearmable	0621231-300	4424,70	1
2x Cable espiral 4m T2 7,4 kW - Max. 14,8 kW Monofásico	0620233-100	4226,23	1
2x Cable recto 5m T2 7,4 kW - Max. 14,8 kW Monofásico	0620232-100	4158,05	1
2x Cable recto 5m T2 7,4 kW - Max. 14,8 kW Monofásico + Modem	0621232-100	4371,66	1
2x Cable espiral 4m T2 7,4 kW - Max. 14,8 kW Monofásico + Modem	0621233-100	4468,76	1
2x Base T2 22 kW - Max. 44 kW Trifásico	0620211-100	4196,14	1
2x Base T2 22 kW - Max. 44 kW Trifásico + Modem	0621211-100	4412,66	1
2x Base T2 22 kW - Max. 44 kW Trifásico + Modem + Diferencial autorearmable	0621211-300	4885,10	1
2x Cable recto 5m T2 22 kW - Max. 44 kW Trifásico	0620212-100	4612,26	1
2x Cable recto 5m T2 22 kW - Max. 44 kW Trifásico + Modem	0621212-100	4825,87	1
2x Cable espiral 4m T2 22 kW - Max. 44 kW Trifásico	0620213-100	4719,89	1
2x Cable espiral 4m T2 22 kW - Max. 44 kW Trifásico + Modem	0621213-100	4922,98	1

PUNTO DE RECARGA PARED

2x Base T2 7,4 kW - Max. 14,8 kW Monofásico	0630231-100	3229,12	1
2x Base T2 7,4 kW - Max. 14,8 kW Monofásico + Modem	0631231-100	3442,74	1
2x Base T2 7,4 kW - Max. 14,8 kW Monofásico + Modem + Diferencial autorearmable	0631231-300	3908,82	1
2x Cable recto 5m T2 7,4 kW - Max. 14,8 kW Monofásico	0630232-100	3701,68	1
2x Cable espiral 4m T2 7,4 kW - Max. 14,8 kW Monofásico	0630233-100	3860,44	1
2x Cable recto 5m T2 7,4 kW - Max. 14,8 kW Monofásico + Modem	0631232-100	3915,29	1
2x Cable espiral 4m T2 7,4 kW - Max. 14,8 kW Monofásico + Modem	0631233-100	4012,40	1
2x Base T2 22 kW - Max. 44 kW Trifásico	0630211-100	3683,34	1
2x Base T2 22 kW - Max. 44 kW Trifásico + Modem	0631211-100	3896,95	1
2x Base T2 22 kW - Max. 44 kW Trifásico + Modem + Diferencial autorearmable	0631211-300	4363,03	1
2x Cable recto 5m T2 22 kW - Max. 44 kW Trifásico	0630212-100	4155,89	1
2x Cable espiral 4m T2 22 kW - Max. 44 kW Trifásico	0630213-100	4367,07	1
2x Cable recto 5m T2 22 kW - Max. 44 kW Trifásico + Modem	0631212-100	4369,51	1
2x Cable espiral 4m T2 22 kW - Max. 44 kW Trifásico + Modem	0631213-100	4466,61	1

ESTÉTICA SERIES 82

Adaptador control de accesos para serie 82 Detail blanco	8200071-030	24,72	1
Adaptador control de accesos para serie 82 Detail grafito	8200071-038	26,08	1
Adaptador control de accesos para serie 82 Detail aluminio	8200071-093	25,87	1

RECARGA DE VEHÍCULOS ELÉCTRICOS

DESCRIPCIÓN	ARTÍCULO	PRECIO € Recomendado	PIEZAS CAJA
SIMON SM20 BUSINESS - PUNTO DE RECARGA PARED			
Base T2 7,4 kW Monofásico	0640141-000	1278,62	1
Base T2 7,4 kW Monofásico + Modem	0641141-000	1481,96	1
Base T2 7,4 kW Monofásico + Automático y Diferencial	0640141-100	1432,67	1
Base T2 7,4 kW Monofásico + Modem + Automático y Diferencial	0641141-100	1636,01	1
Cable recto 5m T2 7,4 kW Monofásico	0640142-000	1401,86	1
Cable recto 5m T2 7,4 kW Monofásico + Modem	0641142-000	1605,20	1
Cable recto 5m T2 7,4 kW Monofásico + Automático y Diferencial	0640142-100	1555,91	1
Cable recto 5m T2 7,4 kW Monofásico + Modem + Automático y Diferencial	0641142-100	1759,25	1
Schuko + Base T2 7,4 kW Monofásico	0640341-000	1535,37	1
Schuko + Base T2 7,4 kW Monofásico + Modem	0641341-000	1738,71	1
Schuko + Base T2 7,4 kW Monofásico + Automático y Diferencial	0640341-100	1689,42	1
Schuko + Base T2 7,4 kW Monofásico + Modem + Automático y Diferencial	0641341-100	1892,76	1
Base T2 22 kW Trifásico	0640121-000	1478,88	1
Base T2 22 kW Trifásico + Modem	0641121-000	1682,23	1
Base T2 22 kW Trifásico + Automático y Diferencial	0640121-100	1632,93	1
Base T2 22 kW Trifásico + Modem + Automático y Diferencial	0641121-100	1836,28	1
Cable recto 5m T2 22 kW Trifásico	0640122-000	1602,12	1
Cable recto 5m T2 22 kW Trifásico + Modem	0641122-000	1805,47	1
Cable recto 5m T2 22 kW Trifásico + Automático y Diferencial	0640122-100	1756,17	1
Cable recto 5m T2 22 kW Trifásico + Modem + Automático y Diferencial	0641122-100	1959,52	1
Schuko + Base T2 22 kW Trifásico	0640321-000	1735,63	1
Schuko + Base T2 22 kW Trifásico + Modem	0641321-000	1938,98	1

DESCRIPCIÓN	ARTÍCULO	PRECIO € Recomendado	PIEZAS CAJA
SIMON SM34 RESIDENCIAL - PUNTO DE RECARGA PARED			
Cable 5m T2 7,4 kW Monofásico	0650042-000	722,55	1
Cable 5m T2 7,4 kW Monofásico + Automático y Diferencial	0650042-100	838,05	1
Cable 5m T2 7,4 kW Monofásico + Automático, Diferencial, Sobretensiones	0650042-300	920,20	1
Cable 5m T2 7,4 kW Mono. + Automático, Diferencial, Sobretensiones con dispositivo automático de rearme de contador	0650042-400	995,20	1
Cable 5m T2 7,4 kW Monofásico + Bluetooth	0651042-000	793,90	1
Cable 5m T2 7,4 kW Monofásico + Bluetooth + Automático y Diferencial	0651042-100	920,20	1
Cable 5m T2 7,4 kW Mono. + Bluetooth + Automático, Diferencial, Sobretensiones	0651042-300	977,90	1
Cable 5m T2 7,4 kW Mono. + Bluetooth + Automático, Diferencial, Sobretensiones con dispositivo automático de rearme de contador	0651042-400	1051,05	1
Cable 5m T2 7,4 kW Monofásico + Contador MID	0650142-000	869,90	1
Cable 5m T2 7,4 kW Monofásico + Contador MID + Automático y Diferencial	0650142-100	996,20	1
Cable 5m T2 7,4 kW Mono. + Contador MID + Automático, Diferencial, Sobretensiones	0650142-300	1052,05	1
Cable 5m T2 22 kW Trifásico	0650022-000	797,00	1
Cable 5m T2 22 kW Trifásico + Automático y Diferencial	0650022-200	943,85	1
Cable 5m T2 22 kW Trifásico + Bluetooth	0651022-000	847,30	1
Cable 5m T2 22 kW Trifásico + Bluetooth + Automático y Diferencial	0651022-200	996,10	1
Cable 5m T2 22 kW Trifásico + Contador MID	0650222-000	997,95	1
Base T2 7,4 kW Monofásico	0650041-000	708,95	1
Base T2 7,4 kW Monofásico + Automático y Diferencial	0650041-100	809,95	1
Base T2 7,4 kW Monofásico + Bluetooth	0651041-000	764,45	1
Base T2 7,4 kW Monofásico + Bluetooth + Automático y Diferencial	0651041-100	894,70	1
Base T2 7,4 kW Monofásico + Contador MID	0650141-000	842,80	1
Base T2 7,4 kW Monofásico + Contador MID + Automático y Diferencial	0650141-100	968,05	1
Base T2 22 kW Trifásico	0650021-000	738,60	1

DESCRIPCIÓN	ARTÍCULO	PRECIO € Recomendado	PIEZAS CAJA
Base T2 22 kW Trifásico + Automático y Diferencial	0650021-100	865,00	1
Base T2 22 kW Trifásico + Bluetooth	0651021-000	819,50	1
Base T2 22 kW Trifásico + Bluetooth + Automático y Diferencial	0651021-100	944,85	1
Base T2 22 kW Trifásico + Contador MID	0650221-000	995,45	1

ACCESORIOS			
Analizador SPL Monofásico + 1 toroidal < 100 A	0691100-000	328,40	1
Analizador SPL Monofásico + 1 toroidal < 200 A	0691200-000	328,40	1
Analizador SPL Monofásico + 1 toroidal < 300 A	0691300-000	328,40	1
Analizador SPL Trifásico + 3 toroidales < 100 A	0692100-000	607,75	1
Analizador SPL Trifásico + 3 toroidales < 200 A	0692200-000	607,75	1
Analizador SPL Trifásico + 3 toroidales < 300 A	0692300-000	607,75	1
Simon Electron Manager	0694002-000	3030,15	1
SM34 Residencial: Lector RFID + 2 Tarjetas RFID	0695000-010	56,50	1
SM34 Residencial: Conexión bluetooth	0695000-020	82,20	1
SM34 Residencial: Modulador dinámico Monofásico vivienda	0695000-030	54,45	1
SM34 Residencial: Modulador dinámico Trifásico vivienda	0695000-040	170,30	1
SM34 Residencial: Modulador Monofásico Fotovoltaica	0695000-050	54,45	1
SM34 Residencial: Modulador Trifásico Fotovoltaica	0695000-060	170,30	1
Barra amarilla de protección pared	0693030-000	130,35	1
Totem Simple SM20	0693010-000	521,90	1
Totem Doble SM20	0693020-000	561,15	1
Totem Simple SM34 para equipos con Cable 5m	0693040-000	396,00	1
Totem Doble SM34 para equipos con Cable 5m	0693050-000	474,50	1
Totem Simple SM34 para equipos con Base T2	0693060-000	392,80	1
Totem Doble SM34 para equipos con Base T2	0693070-000	471,40	1
Kit de 10 tarjetas RFID P&D	0690000-003	28,00	1
Kit de 25 tarjetas RFID P&D	0690000-004	64,00	1
Accesorio Modem 4g	0696000-130	216,55	1
Cable 5m liso T2-T2 (h - m) 32A Monofásico	0697000-085	211,25	1
Cable 5m liso T2-T2 (h - m) 32A Trifásico	0697000-095	268,25	1
Cable 4m espiral T2-T2 (h - m) 32A Monofásico	0697000-105	274,90	1
Cable 4m espiral T2-T2 (h - m) 32A Trifásico	0697000-115	351,90	1
Cable 5m liso T1-T2 (h - m) 32A Monofásico	0697000-125	243,90	1
Accesorio Analizador SPL Trifásico + 3 toroidales < 600 A	0692600-000	647,55	1
Accesorio Analizador SPL Trifásico + 3 toroidales < 1000 A	0692M00-000	647,55	1



SIMON XENON BUSINESS - PUNTO DE RECARGA PARED			
Simon Xenon Business Punto de Recarga pared Base T2 7,4 kW Monofásico + Automático y Diferencial	0660141-100	1310,00	1
Simon Xenon Business Punto de Recarga pared 2x Base T2 7,4 kW Monofásico - Max. 14,8 kW	0660231-000	1730,00	1
Simon Xenon Business Punto de Recarga pared 2x Base T2 7,4 kW Monofásico + Automático y Diferencial - Max. 14,8 kW	0660231-100	1970,00	1
Simon Xenon Business Punto de Recarga pared Schuko + Base T2 7,4 kW Monofásico	0660341-000	1440,00	1

DESCRIPCIÓN	ARTÍCULO	PRECIO € Recomendado	PIEZAS CAJA
Simon Xenon Business Punto de Recarga pared Schuko + Base T2 7,4 kW Monofásico + Automático y Diferencial	N 0660341-100	1560,00	1
Simon Xenon Business Punto de recarga pared Base T2 22 kW Trifásico	N 0660121-000	1400,00	1
Simon Xenon Business Punto de recarga pared Base T2 22 kW Trifásico + Automático y Diferencial	N 0660121-100	1520,00	1
Simon Xenon Business Punto de recarga pared 2x Base T2 22 kW Trifásico - Max. 44 kW	N 0660211-000	2110,00	1
Simon Xenon Business Punto de Recarga pared Schuko + Base T2 22 kW Trifásico	N 0660321-000	1650,00	1
Simon Xenon Business Punto de Recarga pared Cable 6m T2 7,4 kW Monofásico	N 0660142-000	1275,00	1
Simon Xenon Business Punto de Recarga pared Cable 6m T2 7,4 kW Monofásico + Automático y Diferencial	N 0660142-100	1395,00	1
Simon Xenon Business Punto de Recarga pared 2x Cable 6m T2 7,4 kW Monofásico - Max. 14,8 kW	N 0660232-000	1900,00	1
Simon Xenon Business Punto de Recarga pared 2x Cable 6m T2 7,4 kW Monofásico + Automático y Diferencial - Max. 14,8 kW	N 0660232-100	2140,00	1
Simon Xenon Business Punto de recarga pared Cable 6m T2 22 kW Trifásico	N 0660122-000	1485,00	1
Simon Xenon Business Punto de recarga pared Cable 6m T2 22 kW Trifásico + Automático y Diferencial	N 0660122-100	1605,00	1
Simon Xenon Business Punto de recarga pared 2x Cable 6m T2 22 kW Trifásico - Max. 44 kW	N 0660212-000	2280,00	1



Accesorios eléctricos

ACCESORIOS ELÉCTRICOS

CLAVIJAS, BASES MÓVILES Y ADAPTADORES

Fuente de alimentación 100w	E 8000800-039	332,33	1
Fuente de alimentación 35w	E 81020-38	189,59	1
Clavija bipolar 10A 230V	00160-31	1,40	50
Base enchufe móvil 10A 230V	00165-31	2,39	30
Clavija enchufe tripolar T.T. y neutro	07068-31	15,55	5
Clavija enchufe normal con T.T. Schuko	10431-31	2,05	30
Base enchufe bipolar con T.T. 25A	10436-31	21,35	5
Clavija enchufe bipolar con T.T. 25A	10437-31	17,08	5
Base prolongación schuko	10442-31	2,66	20
Clavija enchufe normal con T.T. schuko	10451-31	2,52	30
Clavija enchufe 25A.	10457-31	13,83	10
Base enchufe bipolar con T.T. Lateral	48442-31	14,75	5
Base enchufe con T.T. 25A	48453-31	17,01	10
Base enchufe III neutro y T.T. Laterales	48472-31	21,46	5
Enchufe III T.T. y n. Indus. Placa unica	48473-31	18,86	10
Caja empotrar 2 elementos	48720-35	3,84	10
Módulo fuente de alimentación 10 w	E 81222-38	56,11	1
Adaptador combi 1 toma 16A 250V + 2 USB 3.15A blanco	E CL118154	18,48	6
Adaptador combi 1 toma 16A 250V + 2 USB 3.15A negro	CL118161	18,48	6
Clavija salida frontal 16A 250V (euroslot)	CL612201	3,89	10
Clavija salida frontal 16A 250V (etiqueta)	CL912201	3,37	14
Clavija salida lateral 16A 250V (euroslot)	CL612202	4,44	10
Clavija salida lateral 16A 250V (etiqueta)	CL912202	4,00	14
Base móvil 16A 250V (euroslot)	CL611201	4,47	10

DESCRIPCIÓN	ARTÍCULO	PRECIO € Recomendado	PIEZAS CAJA
Base móvil 16A 250V (etiqueta)	CL911201	4,12	12
Cargador Quick Charge USB C 20,0W Max.	CL510303	15,39	48
Adaptador con 3 clavijas USB cable enrollable +1 puerto USB A + 1 toma 16A	CL610305	23,00	6
Adaptador Combi USB A + C	CL610306	19,51	6
Base móvil 10A (etiqueta)	CL911101	2,75	2
Clavija 10A (etiqueta)	CL912101	2,15	2

BASES MÚLTIPLES

Base triple con T.T. Lateral	E 10403-31	8,94	10
Base cuadruple con T.T. Lateral	E 10404-31	10,71	10
Base quintuple con T.T. Lateral	E 10405-31	14,24	10
Base doble con T.T.	10462-31	12,43	10
Base triple con T.T.	10463-31	15,94	10
Base cuadruple con T.T.	10464-31	20,90	10
Base sextuple con T.T.	E 10465-31	24,51	5
Base sextuple con T.T. y conexión	E 10475-31	33,25	5
Base multifix 3 tomas con interruptor negro	BM140100	12,32	6
Base multifix 3 tomas con interruptor blanco	BM140209	12,32	6
Base multifix 6 tomas con interruptor negro	BM140308	17,99	6
Base multifix multiplicadora de tomas	BM140407	14,32	6
Base multifix 6 tomas con interruptor blanco	BM140803	18,00	6
Cable multifix 3G1.5 3m blanco	BM150109	5,70	8
Cable multifix 3G1.5 3m blanco	BM150208	9,83	8
Cable multifix 3G1 2m negro	BM150307	5,70	8
Cable multifix 3G1.5 3m negro	BM150406	9,83	8
Base múltiple combi con 3 tomas + 2 USB A + 2 USB C	BM516305	24,72	4
Base múltiple combi con carga inalámbrica con 3 tomas + 2 USB A + 2 USB C	BM516306	39,61	4
Combi ball 3 tomas + 3 USB	E BM516301	23,25	4
Combi ball 3 tomas + 3 USB con inducción	E BM516302	38,54	4
Base múltiple 4 tomas 1,4m c/int (fajín)	BM712401	17,29	6
Base múltiple 6 tomas 1,4m c/int (fajín)	BM712601	20,81	6
Base múltiple 3 tomas + 2 USB 1,4m c/interruptor	BM716301	28,25	4
Base múltiple 5 tomas + 2 USB 1,4m c/interruptor	BM716501	31,51	4
Base 2 tomas con TT blanco (fajín)	N BM713201	6,11	8
Base 3 tomas con TT blanco (faj)	N BM713301	8,02	8
Base 4 tomas con TT blanco (faj)	N BM713402	9,49	8
Base 6 tomas con TT blanco (faj)	N BM713601	13,81	8
Base 3 tomas con TT con int. Blanco (faj)	N BM712302	9,26	8
Base 4 tomas con TT con int. Blanco (faj)	N BM714401	10,96	8
Base 5 tomas con TT con int. Blanco (faj)	N BM714501	12,38	8
Base 6 tomas con TT con int. Blanco (faj)	N BM714601	15,07	8
Base 2 tomas con TT cable 2m blanco (faj)	N BM711201	11,54	8
Base 3 tomas con TT cable 2m blanco (faj)	N BM711301	11,93	8
Base 4 tomas con TT cable 2m blanco (faj)	N BM711401	12,47	8
Base 4 tomas TT cuad. Cable 2m blanco (faj)	N BM711402	15,19	8
Base 5 tomas con TT cable 2m blanco (faj)	N BM711501	14,55	8
Base 6 tomas con TT cable 2m blanco (faj)	N BM711601	15,08	8
Base 3 tomas TT int.Cable 2m blanco (faj)	N BM712301	14,13	8
Base 3 tomas TT inter 3m 3g 1,5 blanco (faj)	N BM712303	15,90	8
Base 4 tomas TT int.Cable 2m blanco (faj)	N BM712400	14,23	8
Base 4 tomas TT int.Cable 3m blanco (faj)	N BM712402	16,57	8
Base 4 tomas TT int.Cable 5m blanco (faj)	N BM712403	23,09	8
Base 5 tomas TT int.Cable 2m blanco (faj)	N BM712501	15,32	8
Base 5 tomas TT inter 3m 3g 1,5 blanco (faj)	N BM712503	16,88	8
Base 6 tomas TT int.Cable 2m blanco (faj)	N BM712600	17,18	8
Base 6 tomas TT int.Cable 3m blanco (faj)	N BM712602	18,90	8
Base 6 tomas TT int.Cable 5m blanco (faj)	N BM712603	24,25	8
Base 4 tomas TT int. Cable 2m negro (faj)	N BM722401	14,10	8
Base 6 tomas TT int. Cable 2m negro (faj)	N BM722601	17,18	8

ACCESORIOS DE ILUMINACIÓN

Pl normal laton	E 00502-35	2,66	25
Pl mignon laton M10	E 00531-32	2,66	25
Pl normal baquelita	00579-31	2,52	20
Pl normal baquelita	00579-32	2,56	20
Pl mignon baquelita M10	00588-31	2,25	20

OTROS

DESCRIPCIÓN	ARTÍCULO	PRECIO € Recomendado	PIEZAS CAJA
Pl mignon baquelita M10	00588-32	2,24	20
Pl E-27 zocalo recto	00590-31	5,16	10
Interruptor de paso	04900-31	7,10	10
Pl E-27 rosca pantalla	10502-31	5,85	25
Pl E-27 ceramica	10517-31	3,86	10
Brida racor M10 con tornillo bloqueo	10517-39	1,72	10
Pl E-14 rosca pantalla	10531-32	5,08	25
Suplemento fijacion	10559-32	0,84	20
Pl goliath porcelana	10562-31	18,71	10
Portalampara normal para obras	10579-32	1,47	50
Arandela fijacion pantalla pl E-27	10611-31	1,08	20
Arandela fijacion pantalla pl E-14	10613-31	1,10	20
Portacebador	55193-31	2,55	50
Pl fluorescente con rotativa	55509-31	1,31	20
Pl fluorescente y portaceb. Con rotativa	55510-31	1,53	20
Pl fluorescente	55566-31	1,54	50
Pl fluorescente con portacebador	55567-31	4,37	50
Pl fluorescente con soporte escuadra	55572-31	3,28	20
Portacebador embornamiento rapido	55800-31	1,08	50

MATERIAL DE INSTALACIÓN

Regleta conexion s/mm2- 1-2,5 (max.4)	10825-31	1,97	10
Regleta conexion s/mm2- 2,5-4 (max.6)	10826-31	3,42	10
Regleta conexion s/mm2- 2,5-6 (max.10)	10827-31	4,37	10
Regleta conexion s/mm2- 6-10 (max.16)	10828-31	10,78	10

MULTIMEDIA

Conector macho para altavoz	10490-31	1,71	10
Conector macho para radio	10498-31	3,20	10
Conector hembra para tv	10499-31	4,71	10
Cable Lightning - USB A blanco 1m	MU100101	21,96	6
Cable USB 2.0 A - micro negro 1m	MU112201	5,51	6
Cable USB 3.1 A - USB C negro 1m	MU133201	12,48	6
Cable USB 3.1 C - USB C negro 1m	MU143201	25,01	6
Cable HDMI 2.0 A - USB A negro 1,5m	MU222215	9,80	6
Cable Ethernet RJ45 Cat6 blanco 3m	MU264103	8,32	6

EXTENSIBLES

Prolongador Expert 4 tomas 1,4m	PL428201	45,00	4
Prolongador Expert de pared 2 tomas 10m	PL728241	67,50	2
Extensible Pro 3T con tapa IP55 20m	EX922501	97,08	1
Extensible Pro 3T con tapa IP55 40m	EX922601	166,00	1



Automatización del hogar

AUTOMATIZACIÓN DEL HOGAR

Detector de movimientos por infrarrojos	10300-31	166,54	1
Detector de movimiento de techo	10301-31	96,52	1
Detector de presencia techo empotrar	10302-31	103,14	1
Detector de presencia regulador de luz techo empotrar	10303-31	211,26	1
Tamper seguridad	81214-39	11,38	5
Detector de inundacion	81860-39	94,53	1
Detector de gas	81861-39	110,23	1
Detector de humos ionicos	81862-39	108,58	1
Sonda para detector de inundacion	81864-39	24,12	1

DESCRIPCIÓN	ARTÍCULO	PRECIO € Recomendado	PIEZAS CAJA
-------------	----------	-------------------------	----------------



Iluminación del hogar

ILUMINACIÓN INTERIOR

Proyector LED 100w	IL416111	68,58	4
Proyector LED con soporte 50w	IL416112	59,78	4
Proyector LED con trípode 2x50w	IL416113	103,38	2
Proyector LED recargable con soporte	IL416109	55,64	4
Proyector LED 10w	IL416101	12,22	4
Proyector LED 20w	IL416102	20,22	4
Proyector LED 30w	IL416103	27,35	4
Proyector LED 50w	IL416104	40,79	4
Proyector LED con sensor 10w	IL416105	21,84	4
Proyector LED con sensor 30w	IL416106	38,52	4
Proyector LED con soporte 30w	IL416107	49,37	4
Proyector LED con trípode 50w	IL416108	74,24	2
Regleta LED cresida 1.3W	IL230061	27,55	4
Regleta LED cresida 2.5W	IL230062	32,13	4



Sonido

SONIDO

Amplificador de potencia 30w	05070-39	303,31	1
Altavoz 5" 7w 16 ohm	05073-39	43,05	1
Rejilla altavoz 5"	05505-30	14,94	1
Rejilla altavoz 5"	05505-38	14,94	1
Altavoz 2"	05562-39	41,12	1
Altavoz 2" para techo	05563-30	44,66	1
Caja empotrar altavoz 5"	05705-39	4,55	10

DESCRIPCIÓN

ARTÍCULO PRECIO € PIEZAS
Recomendado CAJA

DESCRIPCIÓN

ARTÍCULO PRECIO € PIEZAS
Recomendado CAJA

OTROS

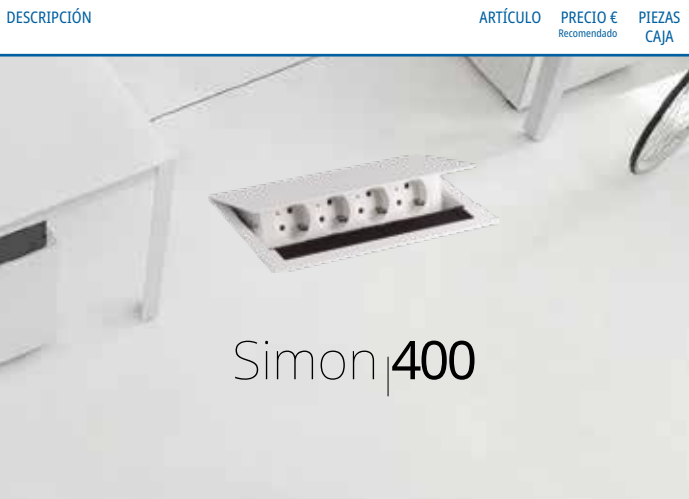

Simon 400

TODOS LOS KITS SE SUMINISTRAN PRECABLEADOS CON UN LATIGUILLO ELÉCTRICO DE CONEXIÓN RÁPIDA DE 3 POLOS CON 22 CM DE LONGITUD.

KITS COMPLETOS SOBRE LA MESA

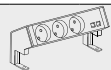

CON BASES DE ENCHUFE

	4 bases de enchufe	42404000-130	83,73	1
		42404000-138	83,73	
	5 bases de enchufe	42505000-130	92,03	1
		42505000-138	92,03	
	6 bases de enchufe	42606000-130	100,33	1
		42606000-138	100,33	

CON BASES DE ENCHUFE + CARGADOR USB

	1 cargador 2xUSB y 2 bases de enchufe schuko	42322000-130	120,01	1
		42322000-138	120,01	
	1 cargador 2xUSB y 3 bases de enchufe schuko	42423000-130	128,31	1
		42423000-138	128,31	
	1 cargador USB A+C y 2 bases de enchufe schuko	42332000-130*	122,45	1
		42332000-138*	122,45	

CON BASES DE ENCHUFE + PLACAS DE VOZ Y DATOS PARA CONECTORES RJ45

	3 bases de enchufe y 2 ventanas para conectores RJ45	42403020-130	97,27	1
		42403020-138	97,27	
	4 bases de enchufe y 2 ventanas para conectores RJ45	42504020-130	99,83	1
		42504020-138	99,83	
	4 bases de enchufe y 4 ventanas para conectores RJ45	42604040-130	106,50	1
		42604040-138	106,50	
	2 bases de enchufe, 2 bases SAI y 2 ventanas para conectores RJ45	42502220-130	107,90	1
		42502220-138	107,90	
	2 bases de enchufe, 2 bases SAI y 4 ventanas para conectores RJ45	42602240-130	119,87	1
		42602240-138	119,87	

CON CARGADOR USB + BASES DE ENCHUFE + PLACAS DE VOZ Y DATOS PARA CONECTORES RJ45

	1 cargador 2xUSB (2.1A), 3 bases de enchufe y 2 ventanas para conectores RJ45	42523020-130	138,71	1
		42523020-138	138,71	
	1 cargador USB A+C, 3 bases de enchufe y placa para 2 conectores RJ45	42533020-130*	141,14	1
		42533020-138*	141,14	

KITS PERSONALIZABLES SOBRE LA MESA

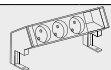

CON 1 BASE DE ENCHUFE + HUECOS PARA VOZ, DATOS Y MULTIMEDIA

	1 base de enchufe y 3 huecos para soluciones configurables	42401000-130	72,03	1
		42401000-138	72,03	

	1 base de enchufe y 4 huecos para soluciones configurables	42501000-130	76,43	1
		42501000-138	76,43	
	1 base de enchufe y 5 huecos para soluciones configurables	42601000-130	80,83	1
		42601000-138	80,83	

CON 2 BASES DE ENCHUFE + HUECOS PARA VOZ, DATOS Y MULTIMEDIA

	2 bases de enchufe y 2 huecos para soluciones configurables	42402000-130	75,93	1
		42402000-138	75,93	
	2 bases de enchufe y 3 huecos para soluciones configurables	42502000-130	80,33	1
		42502000-138	80,33	
	2 bases de enchufe y 4 huecos para soluciones configurables	42602000-130	84,73	1
		42602000-138	84,73	

CON 3 BASES DE ENCHUFE + HUECOS PARA VOZ, DATOS Y MULTIMEDIA

	3 bases de enchufe y 1 hueco para una solución configurable	42403000-130	79,83	1
		42403000-138	79,83	
	3 bases de enchufe y 2 huecos para soluciones configurables	42503000-130	84,23	1
		42503000-138	84,23	
	3 bases de enchufe y 3 huecos para soluciones configurables	42603000-130	88,63	1
		42603000-138	88,63	

CON 4 BASES DE ENCHUFE + HUECOS PARA VOZ, DATOS Y MULTIMEDIA

	4 bases de enchufe y 1 hueco para una solución configurable	42504000-130	88,13	1
		42504000-138	88,13	
	4 bases de enchufe y 2 huecos para soluciones configurables	42604000-130	92,53	1
		42604000-138	92,53	

CON 5 BASES DE ENCHUFE + HUECOS PARA VOZ, DATOS Y MULTIMEDIA

	5 bases de enchufe y 1 hueco para una solución configurable	42605000-130	96,43	1
		42605000-138	96,43	

CON CARGADOR USB + BASES DE ENCHUFE + HUECOS PARA VOZ, DATOS Y MULTIMEDIA

	1 cargador 2xUSB, 2 bases de enchufe y 1 hueco para soluciones configurable	42422000-130	124,41	1
		42422000-138	124,41	
	1 cargador 2xUSB, 3 bases de enchufe y 1 hueco para soluciones configurable	42523000-130	132,71	1
		42523000-138	132,71	
	1 cargador 2xUSB, 3 bases de enchufe y 2 huecos para soluciones configurables	42623000-130	137,11	1
		42623000-138	137,11	
	1 cargador 2xUSB, 4 bases de enchufe y 1 hueco para soluciones configurables	42624000-130	141,01	1
		42624000-138	141,01	
	1 cargador USB A+C, 2 bases de enchufe y 1 hueco para soluciones configurables	42432000-130*	126,85	1
		42432000-138*	126,85	

KITS COMPLETOS DENTRO DE LA MESA CON TAPA SALIDA CABLE CEPILLO

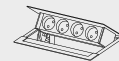

CON BASES DE ENCHUFE

	4 bases de enchufe	44404000-130	194,16	1
		44404000-138	194,16	
	5 bases de enchufe	44505000-130	207,10	1
		44505000-138	207,10	
	6 bases de enchufe	44606000-130	220,09	1
		44606000-138	220,09	

CON CARGADOR USB + BASES DE ENCHUFE

	1 cargador 2xUSB y 3 bases de enchufe	44423000-130	238,74	1
		44423000-138	238,74	

CON 3 BASES DE ENCHUFE + PLACAS DE VOZ Y DATOS PARA CONECTORES RJ45

	3 bases de enchufe schuko y placa para 2 conectores RJ45	44403020-130	211,35	1
		44403020-138	211,35	

*Consultar disponibilidad

DESCRIPCIÓN

ARTÍCULO PRECIO € PIEZAS
Recomendado CAJA

CON 4 BASES DE ENCHUFE +
PLACAS DE VOZ Y DATOS PARA CONECTORES RJ45

	4 bases de enchufe y placa para 2 conectores RJ45	44504020-130	224,20	1
		44504020-138	224,20	
	4 bases de enchufe y placa para 4 conectores RJ45	44604040-130	237,04	1
		44604040-138	237,04	
	2 bases de enchufe, 2 bases SAI y placa para 2 conectores RJ45	44502220-130	237,82	1
		44502220-138	237,82	
	2 bases de enchufe, 2 bases SAI y placa para 4 conectores RJ45	44602240-130	250,67	1
		44602240-138	250,67	

CON CARGADOR USB + BASES DE ENCHUFE +
PLACAS DE VOZ Y DATOS PARA CONECTORES RJ45

	1 cargador 2xUSB, 3 bases de enchufe y placa para 2 conectores RJ45	44523020-130	255,68	1
		44523020-138	255,68	
	1 cargador USB A+C, 3 bases de enchufe y placa para 2 conectores RJ45	44533020-130*	260,60	1
		44533020-138*	260,60	

KITS COMPLETOS DENTRO DE LA MESA
CON TAPA SALIDA CABLE ALETA METÁLICA

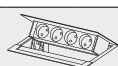

CON BASES DE ENCHUFE

	4 bases de enchufe schuko	45404000-130	232,95	1
		45404000-138	232,95	
	5 bases de enchufe schuko	45505000-130	248,56	1
		45505000-138	248,56	
	6 bases de enchufe schuko	45606000-130	264,07	1
		45606000-138	264,07	

CON CARGADOR USB + BASES DE ENCHUFE

	1 cargador 2xUSB y 3 bases de enchufe	45423000-130	277,53	1
		45423000-138	277,53	

CON 3 BASES DE ENCHUFE +
PLACAS DE VOZ Y DATOS PARA CONECTORES RJ45

	3 bases de enchufe y placa para 2 conectores RJ45	45403020-130	249,77	1
		45403020-138	249,77	

CON 4 BASES DE ENCHUFE +
PLACAS DE VOZ Y DATOS PARA CONECTORES RJ45

	4 bases de enchufe schuko y placa para 2 conectores RJ45	45504020-130	265,19	1
		45504020-138	265,19	
	4 bases de enchufe schuko y placa para 4 conectores RJ45	45604040-130	280,60	1
		45604040-138	280,60	
	2 bases de enchufe schuko, 2 bases SAI y placa para 2 conectores RJ45	45502220-130	278,82	1
		45502220-138	278,82	
	2 bases de enchufe schuko, 2 bases SAI y placa para 4 conectores RJ45	45602240-130	294,21	1
		45602240-138	294,21	

CON CARGADOR USB + BASES DE ENCHUFE +
PLACAS DE VOZ Y DATOS PARA CONECTORES RJ45

	1 cargador 2xUSB, 3 bases de enchufe y placa para 2 conectores RJ45	45523020-130	296,66	1
		45523020-138	296,66	

KITS PERSONALIZABLES DENTRO DE LA MESA
CON TAPA SALIDA CABLE CEPILLO

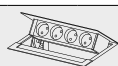

CON CARGADOR USB + BASES DE ENCHUFE +
HUECOS PARA VOZ, DATOS Y MULTIMEDIA

	1 cargador 2xUSB (2.1A), 2 bases de enchufe y 1 hueco para una solución configurable	44422000-130	234,85	1
		44422000-138	234,85	
	1 cargador USB A+C, 2 bases de enchufe y 1 hueco para una solución configurable	44432000-130*	237,28	1
		44432000-138*	237,28	
	1 cargador 2xUSB (2.1A), 3 bases de enchufe y 2 huecos para soluciones configurables	44623000-130	256,87	1
		44623000-138	256,87	

DESCRIPCIÓN

ARTÍCULO PRECIO € PIEZAS
Recomendado CAJA

	1 cargador USB A+C, 3 bases de enchufe y 2 huecos para soluciones configurables	44633000-130*	259,31	1
		44633000-138*	259,31	
	1 cargador 2xUSB, 4 bases de enchufe y 1 hueco para soluciones configurables	44624000-130	260,77	1
		44624000-138	260,77	

CON 1 BASE DE ENCHUFE +
HUECOS PARA VOZ, DATOS Y MULTIMEDIA

	1 base de enchufe y 3 huecos para soluciones configurables	44401000-130	182,47	1
		44401000-138	182,47	
	1 base de enchufe y 4 huecos para soluciones configurables	44501000-130	191,51	1
		44501000-138	191,51	
	1 base de enchufe y 5 huecos para soluciones configurables	44601000-130	200,60	1
		44601000-138	200,60	

CON 2 BASES DE ENCHUFE +
HUECOS PARA VOZ, DATOS Y MULTIMEDIA

	2 bases de enchufe y 2 huecos para soluciones configurables	44402000-130	186,37	1
		44402000-138	186,37	
	2 bases de enchufe y 3 huecos para soluciones configurables	44502000-130	195,40	1
		44502000-138	195,40	
	2 bases de enchufe y 4 huecos para soluciones configurables	44602000-130	204,49	1
		44602000-138	204,49	

CON 3 BASES DE ENCHUFE +
HUECOS PARA VOZ, DATOS Y MULTIMEDIA

	3 bases de enchufe y 1 hueco para solución configurable	44403000-130	190,26	1
		44403000-138	190,26	
	3 bases de enchufe y 2 huecos para soluciones configurables	44503000-130	199,30	1
		44503000-138	199,30	
	3 bases de enchufe y 3 huecos para soluciones configurables	44603000-130	208,39	1
		44603000-138	208,39	

CON 4 BASES DE ENCHUFE +
HUECOS PARA VOZ, DATOS Y MULTIMEDIA

	4 bases de enchufe y 1 hueco para solución configurable	44504000-130	203,20	1
		44504000-138	203,20	
	4 bases de enchufe y 2 huecos para soluciones configurables	44604000-130	212,29	1
		44604000-138	212,29	

CON 5 BASES DE ENCHUFE +
HUECOS PARA VOZ, DATOS Y MULTIMEDIA

	5 bases de enchufe y 1 hueco para solución configurable	44605000-130	216,19	1
		44605000-138	216,19	

KITS PERSONALIZABLES DENTRO DE LA MESA
CON TAPA SALIDA CABLE ALETA METÁLICA

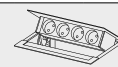

CON CARGADOR USB + BASES DE ENCHUFE +
HUECOS PARA VOZ, DATOS Y MULTIMEDIA

	1 cargador 2xUSB, 2 bases de enchufe y 1 hueco para una solución configurable	45422000-130	273,63	1
		45422000-138	273,63	
	1 cargador 2xUSB, 3 bases de enchufe y 1 hueco para una solución configurable	45523000-130	289,24	1
		45523000-138	289,24	
	1 cargador 2xUSB, 3 bases de enchufe y 2 huecos para soluciones configurables	45623000-130	300,86	1
		45623000-138	300,86	
	1 cargador 2xUSB, 4 bases de enchufe y 1 hueco para soluciones configurables	45624000-130	304,76	1
		45624000-138	304,76	

CON 1 BASE DE ENCHUFE +
HUECOS PARA VOZ, DATOS Y MULTIMEDIA

	1 base de enchufe y 3 huecos para soluciones configurables	45401000-130	221,25	1
		45401000-138	221,25	
	1 base de enchufe y 4 huecos para soluciones configurables	45501000-130	232,97	1
		45501000-138	232,97	
	1 base de enchufe y 5 huecos para soluciones configurables	45601000-130	244,58	1
		45601000-138	244,58	

*Consultar disponibilidad

CONECTIVIDAD

SIMON 400

DESCRIPCIÓN

ARTÍCULO PRECIO € PIEZAS
 Recomendado CAJA

CON 2 BASES DE ENCHUFE + HUECOS PARA VOZ, DATOS Y MULTIMEDIA

	2 bases de enchufe y 2 huecos para soluciones configurables	45402000-130	225,15	1
		45402000-138	225,15	
	2 bases de enchufe y 3 huecos para soluciones configurables	45502000-130	236,87	1
		45502000-138	236,87	
	2 bases de enchufe y 4 huecos para soluciones configurables	45602000-130	248,48	1
		45602000-138	248,48	

CON 3 BASES DE ENCHUFE + HUECOS PARA VOZ, DATOS Y MULTIMEDIA

	3 bases de enchufe y 1 hueco para solución configurable	45403000-130	229,05	1
		45403000-138	229,05	
	3 bases de enchufe y 2 huecos para soluciones configurables	45503000-130	240,76	1
		45503000-138	240,76	
	3 bases de enchufe y 3 huecos para soluciones configurables	45603000-130	252,38	1
		45603000-138	252,38	

CON 4 BASES DE ENCHUFE + HUECOS PARA VOZ, DATOS Y MULTIMEDIA

	4 bases de enchufe y 1 hueco para solución configurable	45504000-130	244,66	1
		45504000-138	244,66	
	4 bases de enchufe y 2 huecos para soluciones configurables	45604000-130	256,28	1
		45604000-138	256,28	

CON 5 BASES DE ENCHUFE + HUECOS PARA VOZ, DATOS Y MULTIMEDIA

	5 bases de enchufe y 1 hueco para solución configurable	45605000-130	260,18	1
		45605000-138	260,18	

KITS COMPLETOS DENTRO DE LA MESA CON TAPA DOBLE SALIDA CABLE CEPILLO

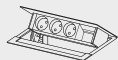

CON BASES DE ENCHUFE

	8 bases de enchufe	46404000-130	388,32	1
		46404000-138	388,32	
	12 bases de enchufe	46606000-130	440,18	1
		46606000-138	440,18	

CON CARGADOR USB + BASES DE ENCHUFE

	Cargador 4xUSB y 6 bases de enchufe	46423000-130	477,49	1
		46423000-138	477,49	

CON 6 BASES DE ENCHUFE + PLACAS DE VOZ Y DATOS PARA CONECTORES RJ45

	6 bases de enchufe y placa para 4 conectores RJ45	46403020-130	422,70	1
		46403020-138	422,70	

CON 8 BASES DE ENCHUFE + PLACAS DE VOZ Y DATOS PARA CONECTORES RJ45

	8 bases de enchufe y placa para 8 conectores RJ45	46604040-130	474,09	1
		46604040-138	474,09	
	4 bases de enchufe, 4 bases SAI y placa para 8 conectores RJ45	46602240-130	501,35	1
		46602240-138	501,35	

KITS COMPLETOS DENTRO DE LA MESA CON TAPA DOBLE SALIDA CABLE ALETA METÁLICA

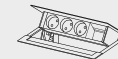

CON BASES DE ENCHUFE

	8 bases de enchufe	47404000-130	465,89	1
		47404000-138	465,89	
	12 bases de enchufe	47606000-130	528,15	1
		47606000-138	528,15	

DESCRIPCIÓN

ARTÍCULO PRECIO € PIEZAS
 Recomendado CAJA

CON CARGADOR USB + BASES DE ENCHUFE

	Cargador 4xUSB y 6 bases de enchufe	47423000-130	555,06	1
		47423000-138	555,06	

CON 6 BASES DE ENCHUFE + PLACAS DE VOZ Y DATOS PARA CONECTORES RJ45

	6 bases de enchufe schuko, placa para 4 conectores RJ45	47403020-130	499,53	1
		47403020-138	499,53	

CON 8 BASES DE ENCHUFE + PLACAS DE VOZ Y DATOS PARA CONECTORES RJ45

	8 bases de enchufe y placa para 8 conectores RJ45	47604040-130	561,20	1
		47604040-138	561,20	
	4 bases de enchufe, 4 bases SAI, placa para 8 conectores RJ45	47602240-130	588,45	1
		47602240-138	588,45	

KITS PERSONALIZABLES DENTRO DE LA MESA CON TAPA DOBLE SALIDA CABLE CEPILLO

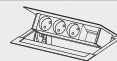

CON CARGADOR USB + BASES DE ENCHUFE + HUECOS PARA VOZ, DATOS Y MULTIMEDIA

	Cargador 4xUSB, 4 bases de enchufe schuko y 2 huecos para soluciones configurables	46422000-130	469,69	1
		46422000-138	469,69	
	Cargador 4xUSB, 6 bases de enchufe schuko y 4 huecos para soluciones configurables	46623000-130	513,75	1
		46623000-138	513,75	
	Cargador 4xUSB, 8 bases de enchufe schuko y 2 huecos para soluciones configurables	46624000-130	521,54	1
		46624000-138	521,54	

CON 2 BASES DE ENCHUFE + HUECOS PARA VOZ, DATOS Y MULTIMEDIA

	2 schukos y 6 huecos para soluciones configurables	46401000-130	364,93	1
		46401000-138	364,93	
	2 schukos y 10 huecos para soluciones configurables	46601000-130	401,19	1
		46601000-138	401,19	

CON 4 BASES DE ENCHUFE + HUECOS PARA VOZ, DATOS Y MULTIMEDIA

	4 schukos y 4 huecos para soluciones configurables	46402000-130	372,73	1
		46402000-138	372,73	
	4 schukos y 8 huecos para soluciones configurables	46602000-130	408,99	1
		46602000-138	408,99	

CON 6 BASES DE ENCHUFE + HUECOS PARA VOZ, DATOS Y MULTIMEDIA

	6 schukos y 2 huecos para soluciones configurables	46403000-130	380,53	1
		46403000-138	380,53	
	6 schukos y 6 huecos para soluciones configurables	46603000-130	416,79	1
		46603000-138	416,79	

CON 8 BASES DE ENCHUFE + HUECOS PARA VOZ, DATOS Y MULTIMEDIA

	8 schukos y 4 huecos para soluciones configurables	46604000-130	424,58	1
		46604000-138	424,58	

CON 10 BASES DE ENCHUFE + HUECOS PARA VOZ, DATOS Y MULTIMEDIA

	10 schukos y 2 huecos para soluciones configurables	46605000-130	432,38	1
		46605000-138	432,38	

*Consultar disponibilidad

DESCRIPCIÓN

ARTÍCULO PRECIO € PIEZAS
Recomendado CAJA

KITS PERSONALIZABLES DENTRO DE LA MESA
CON TAPA DOBLE SALIDA CABLE ALETA METÁLICA

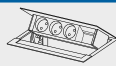

CON CARGADOR USB + BASES DE ENCHUFE +
HUECOS PARA VOZ, DATOS Y MULTIMEDIA

	Cargador 4xUSB, 4 bases de enchufe schuko y 2 huecos para soluciones configurables	47422000-130	547,26	1
		47422000-138	547,26	
	Cargador 6xUSB, 6 bases de enchufe schuko y 4 huecos para soluciones configurables	47623000-130	601,72	1
		47623000-138	601,72	
	Cargador 4xUSB, 8 bases de enchufe schuko y 2 huecos para soluciones configurables	47624000-130	609,51	1
		47624000-138	609,51	

CON 2 BASES DE ENCHUFE +
HUECOS PARA VOZ, DATOS Y MULTIMEDIA

	2 schukos y 6 huecos para soluciones configurables	47401000-130	442,50	1
		47401000-138	442,50	
	2 schukos y 10 huecos para soluciones configurables	47601000-130	489,16	1
		47601000-138	489,16	

CON 4 BASES DE ENCHUFE +
HUECOS PARA VOZ, DATOS Y MULTIMEDIA

	4 schukos y 4 huecos para soluciones configurables	47402000-130	450,30	1
		47402000-138	450,30	
	4 schukos y 8 huecos para soluciones configurables	47602000-130	496,96	1
		47602000-138	496,96	

CON 6 BASES DE ENCHUFE +
HUECOS PARA VOZ, DATOS Y MULTIMEDIA

	6 schukos y 2 huecos para soluciones configurables	47403000-130	458,10	1
		47403000-138	458,10	
	6 schukos y 6 huecos para soluciones configurables	47603000-130	504,76	1
		47603000-138	504,76	

CON 8 BASES DE ENCHUFE +
HUECOS PARA VOZ, DATOS Y MULTIMEDIA

	8 schukos y 4 huecos para soluciones configurables	47604000-130	512,55	1
		47604000-138	512,55	

CON 10 BASES DE ENCHUFE +
HUECOS PARA VOZ, DATOS Y MULTIMEDIA

	Con aleta metálica, 10 schukos y 2 huecos para soluciones configurables	47605000-130	520,35	1
		47605000-138	520,35	

TOMAS DE CONEXIÓN INDIVIDUAL

	Toma de corriente panelable con base de enchufe Schuko y latiguillo de 20 centímetros terminado en extremo libre blanco/negro S400	43101000-130	31,50	1
		43101000-138	31,50	
	Toma de corriente panelable con base de enchufe Schuko y latiguillo de 20 centímetros terminado en conector rápido blanco/negro S400	43101002-130	35,25	1
		43101002-138	35,25	
	Tapa accesoriale tomas de corriente panelables blanco/negro S400	43100001-130	20,30	1
		43100001-138	20,30	
	Cargador USB A+C panelable y latiguillo de 20 centímetros terminado en extremo libre blanco/negro S400	43120000-130	61,06	1
		43120000-138	61,06	
	Cargador USB A+C panelable y latiguillo de 20 centímetros terminado en conector rápido blanco/negro S400	43120200-130	64,80	1
		43120200-138	64,80	
	Tapa accesoriale para cargador USB A+C panelable blanco/negro S400	43100002-130	20,30	1
		43100002-138	20,30	

DESCRIPCIÓN

ARTÍCULO PRECIO € PIEZAS
Recomendado CAJA

PLACAS DE VOZ Y DATOS PARA CONECTORES RJ45



PLACA PARA 2 CONECTORES RJ45

Placa plana con guardapolvo para 2 conectores RJ45 con clipaje Keystone® I, II, ATT® y Avaya®	40000089-030	3,73	10
	40000089-038	3,73	
Placa plana sin guardapolvo para 2 conectores RJ45 con clipaje Keystone® I, II, ATT® y Avaya®	40000189-030	2,31	10
	40000189-038	2,31	
Placa plana sin guardapolvo para 2 conectores RJ45 con clipaje 3M®	40011189-030	2,31	10
	40011189-038	2,31	
Placa plana con guardapolvo para 2 conectores RJ45 con clipaje BeldenCDT®	40013089-030	3,73	10
	40013089-038	3,73	
Placa plana con guardapolvo para 2 conectores RJ45 con clipaje Infra+®	40015089-030	3,73	10
	40015089-038	3,73	
Placa plana sin guardapolvo para 2 conectores RJ45 con clipaje Infra+®	40015189-030	2,31	10
	40015189-038	2,31	
Placa plana con guardapolvo para 2 conectores RJ45 con clipaje ITT Cannon®	40016089-030	3,73	10
	40016089-038	3,73	
Placa plana con guardapolvo para 2 conectores RJ45 con clipaje Panduit®	40019089-030	3,73	10
	40019089-038	3,73	
Placa plana sin guardapolvo para 2 conectores RJ45 con clipaje Panduit®	40019189-030	2,31	10
	40019189-038	2,31	

PLACAS MULTIMEDIA CON CONECTORES



PLACAS MULTIMEDIA CON CONECTORES HEMBRA-HEMBRA

HDMI Tipo "A" hembra-hembra con latiguillo de 22 cm	40001194-030	53,84	1
	40001194-038	53,84	
VGA + minijack hembra-hembra con latiguillo de 22 cm para VGA y 14 cm para minijack	40000191-030	54,97	1
	40000191-038	54,97	
3 conectores RCA audio hembra-hembra con latiguillos de 14 cm	40001193-030	68,73	1
	40001193-038	68,73	
USB datos Tipo "A" hembra-hembra con latiguillo de 22 cm	40001191-030	50,39	1
	40001191-038	50,39	

PLACAS CIEGAS



Placa ciega	40000800-030	2,78	10
	40000800-038	2,78	

SALIDA DE CABLES



Salida de cables Simon 500 Cima ø102mm para mesa o suelo técnico	52055000-030	11,93	5
	52055000-038	12,17	
	52055000-033	24,25	



Simon 500 Cima

KITS SIMON 500 CIMA

Las bases eléctricas de los Kits son embornamiento por corte con led y las placas de V&D son planas con guardapolvo para 1 o 2 conectores RJ45 Simon, AMP®, Brand Rex®, Systimax® (Avaya®), Krone® o BeldenCDT®



KITS CAJAS DE PARED SIMON 500 CIMA

2 MÓDULOS

2 BASES DOBLES ELÉCTRICAS

	Con enlazador	51000201-030	55,91	1
		51000201-038	56,95	
		51000201-033	71,33	

1 BASE DOBLE ELÉCTRICA Y 2 PLACAS DE V&D

	Para 1 conector RJ45 formato "universal"	51000202-030	45,54	1
		51000202-038	46,46	
		51000202-033	61,92	

1 BASE DOBLE ELÉCTRICA PARA SAI Y 2 PLACAS DE V&D

	Para 1 conector RJ45 formato "universal"	51000203-030	45,54	1
		51000203-038	46,09	
		51000203-033	60,85	

BASE CAJA DE PARED SUPERFICIE Y EMPOTRAR PARA KITS 2 MÓDULOS

	Base caja de pared de superficie Simon 500 Cima para kit 2 módulos	51050002-030	8,37	1
		51050002-038	8,54	
		51050002-033	16,20	
	Cajetin de empotrar Simon 500 Cima para kit 2 módulos	51020102-039	12,80	1

3 MÓDULOS

2 BASES DOBLES ELÉCTRICAS Y 2 PLACAS DE V&D

	Para 1 conector RJ45 formato "universal"	51000301-030	71,02	1
		51000301-038	72,40	
		51000301-033	94,05	
	Con 2 conectores RJ45 Cat.6 UTP	51000307-030	94,11	1
		51000307-038	95,35	
		51000307-033	115,91	

	Para 1 conector RJ45 formato "universal" y con tapa abatible	51000303-030	74,96	1
		51000303-038	76,42	
		51000303-033	117,22	

1 BASE DOBLE ELÉCTRICA, 1 BASE DOBLE ELÉCTRICA PARA SAI Y 2 PLACAS DE V&D

	Para 1 conector RJ45 formato "universal"	51000302-030	68,85	1
		51000302-038	69,84	
		51000302-033	90,82	
	Con 2 conectores RJ45 Cat.6 UTP	51000308-030	91,94	1
		51000308-038	92,79	
		51000308-033	112,67	
	Para 1 conector RJ45 formato "universal" y con tapa abatible	51000304-030	72,78	1
	Para 2 conectores RJ45 formato "universal"	51000305-030	72,82	1
		51000305-038	73,86	
		51000305-033	95,31	
	Con 1 módulo libre Para personalizar	51000309-030	57,45	1

BASE CAJA DE PARED SUPERFICIE Y EMPOTRAR PARA KITS 3 MÓDULOS

	Base caja de pared de superficie Simon 500 Cima Para kit 3 módulos	51050003-030	12,20	1
		51050003-038	12,40	
		51050003-033	23,60	
	Cajetin de empotrar Simon 500 Cima Para kit 3 módulos	51020103-039	16,05	1

4 MÓDULOS

2 BASES DOBLES ELÉCTRICAS, 1 BASE DOBLE ELÉCTRICA PARA SAI Y 2 PLACAS DE V&D

	Para 2 conectores RJ45 formato "universal"	51000401-030	97,24	1

2 BASES DOBLES ELÉCTRICAS, 1 BASE INDIVIDUAL, 1 BASE DOBLE ELÉCTRICA PARA SAI Y 2 PLACAS DE V&D

	Para 2 conectores RJ45 formato "universal" y 1 cargador USB	51000402-030	142,27	1

1 BASE DOBLE ELÉCTRICA, 2 BASES DOBLES ELÉCTRICAS PARA SAI Y 2 PLACAS DE V&D



	Para 2 conectores RJ45 formato "universal"	51000403-030	97,24	1

BASE CAJA DE PARED SUPERFICIE Y EMPOTRAR PARA KITS 4 MÓDULOS

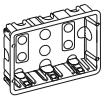
	Base caja de pared de superficie Simon 500 Cima para kit 4 módulos	51050004-030	16,04	1



DESCRIPCIÓN	ARTÍCULO	PRECIO € Recomendado	PIEZAS CAJA
 Cajetín de empotrar Simon 500 Cima para kit 4 módulos	51020104-039	20,27	1
Se debe completar el kit con la base de la caja de pared de superficie o cajetín de empotrar Simon 500 CIMA.			

KITS CAJAS DE SUELO PARA PAVIMENTO SIMON 500 CIMA (PROFUNDIDAD REGULABLE 70 A 100 MM)

3 MÓDULOS			
2 BASES DOBLES ELÉCTRICAS Y 2 PLACAS DE V&D			
 Para 1 conector RJ45 formato "universal"	52006301-030	119,80	1
1 BASE DOBLE ELÉCTRICA, 1 BASE DOBLE ELÉCTRICA PARA SAI Y 2 PLACAS DE V&D			
 Para 1 conector RJ45 formato "universal"	52006302-030	119,80	1
 Para 2 conectores RJ45 formato "universal"	52006305-030	123,79	1

4 MÓDULOS			
2 BASES DOBLES ELÉCTRICAS, 1 BASE DOBLE ELÉCTRICA PARA SAI Y 2 PLACAS DE V&D			
 Para 2 conectores RJ45 formato "universal"	52006401-030	143,10	1

KITS CAJAS DE SUELO PARA SUELO TÉCNICO SIMON 500 CIMA (PROFUNDIDAD REGULABLE 90 A 120 MM)



3 MÓDULOS			
2 BASES DOBLES ELÉCTRICAS Y 2 PLACAS DE V&D			
 Para 1 conector RJ45 formato "universal"	52006306-030	120,93	1
1 BASE DOBLE ELÉCTRICA, 1 BASE DOBLE ELÉCTRICA PARA SAI Y 2 PLACAS DE V&D			
 Para 1 conector RJ45 formato "universal"	52006307-030	120,93	1
 Para 2 conectores RJ45 formato "universal"	52006310-030	124,92	1

4 MÓDULOS			
2 BASES DOBLES ELÉCTRICAS, 1 BASE DOBLE ELÉCTRICA PARA SAI Y 2 PLACAS DE V&D			
 Para 2 conectores RJ45 formato "universal"	52006404-030	154,99	1

DESCRIPCIÓN	ARTÍCULO	PRECIO € Recomendado	PIEZAS CAJA
1 PLACA PARA PROTECCIÓN GUÍA DIN, 1 BASE DOBLE ELÉCTRICA, 1 BASE DOBLE ELÉCTRICA PARA SAI Y 2 PLACAS DE V&D			
 Para 2 conectores RJ45 formato "universal"	52006402-030	149,29	1

KITS CAJAS DE SUELO PARA PROFUNDIDAD REDUCIDA SIMON 500 CIMA (PROFUNDIDAD 69 MM)

2 MÓDULOS			
1 BASE DOBLE ELÉCTRICA Y 2 PLACAS DE V&D			
 Para 1 conector RJ45 formato "universal"	52006311-030	90,35	1
3 MÓDULOS			
2 BASES DOBLES ELÉCTRICAS Y 2 PLACAS DE V&D			
 Para 1 conector RJ45 formato "universal"	52006312-030	115,12	1

1 BASE DOBLE ELÉCTRICA, 1 BASE DOBLE ELÉCTRICA PARA SAI Y 2 PLACAS DE V&D			
 Para 1 conector RJ45 formato "universal"	52006313-030	115,12	1
 Para 2 conectores RJ45 formato "universal"	52006316-030	119,11	1

4 MÓDULOS			
2 BASES DOBLES ELÉCTRICAS, 1 BASE DOBLE ELÉCTRICA PARA SAI Y 2 PLACAS DE V&D			
 Para 2 conectores RJ45 formato "universal"	52006406-030	144,06	1

ENVOLVENTES METÁLICOS SIMON 500 CIMA

KITS CAJAS DE PARED DE SUPERFÍCIE SIMON 500 CIMA

3 MÓDULOS			
2 BASES DOBLES ELÉCTRICAS Y 2 PLACAS DE V&D			
 Para 1 conector RJ45 formato "universal"	51001301-036	133,32	1
1 BASE DOBLE ELÉCTRICA, 1 BASE DOBLE ELÉCTRICA PARA SAI Y 2 PLACAS DE V&D			
 Para 1 conector RJ45 formato "universal"	51001302-036	132,94	1

CONECTIVIDAD

SIMON 500 CIMA

DESCRIPCIÓN	ARTÍCULO	PRECIO € Recomendado	PIEZAS CAJA
-------------	----------	-------------------------	----------------

4 MÓDULOS

1 BASE DOBLE ELÉCTRICA, 2 BASES DOBLES ELÉCTRICAS PARA SAI Y 2 PLACAS DE V&D

	Para 2 conectores RJ45 formato "universal"	51001401-036	173,83	1
--	--	---------------------	--------	---

KITS CAJAS DE PARED DE EMPOTRAR SIMON 500 CIMA

3 MÓDULOS

2 BASES DOBLES ELÉCTRICAS Y 2 PLACAS DE V&D

	Para 1 conector RJ45 formato "universal"	51002301-036	142,57	1
--	--	---------------------	--------	---

1 BASE DOBLE ELÉCTRICA, 1 BASE DOBLE ELÉCTRICA PARA SAI Y 2 PLACAS DE V&D

	Para 1 conector RJ45 formato "universal"	51002302-036	142,19	1
--	--	---------------------	--------	---

4 MÓDULOS

1 BASE DOBLE ELÉCTRICA, 2 BASES DOBLES ELÉCTRICAS PARA SAI Y 2 PLACAS DE V&D

	Para 2 conectores RJ45 formato "universal"	51002401-036	183,57	1
--	--	---------------------	--------	---

KITS TORRETA SIMON 500 CIMA

3 ALTURAS

2 BASES DOBLES ELÉCTRICAS Y 2 PLACAS DE V&D

	Para 1 conector RJ45 formato "universal"	52516301-036	169,26	1
--	--	---------------------	--------	---

1 BASE DOBLE ELÉCTRICA, 1 BASE DOBLE ELÉCTRICA PARA SAI Y 2 PLACAS DE V&D

	Para 1 conector RJ45 formato "universal"	52516302-036	168,88	1
--	--	---------------------	--------	---

4 ALTURAS



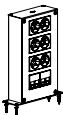

1 BASE DOBLE ELÉCTRICA, 2 BASES DOBLES ELÉCTRICAS PARA SAI Y 2 PLACAS DE V&D

	Para 2 conectores RJ45 formato "universal"	52516401-036	208,62	1
--	--	---------------------	--------	---

DESCRIPCIÓN	ARTÍCULO	PRECIO € Recomendado	PIEZAS CAJA
-------------	----------	-------------------------	----------------

BASES ELÉCTRICAS SIMON 500 CIMA

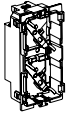
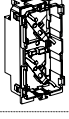



BASES ELÉCTRICAS SIMON 500 CIMA CON LED

	Base doble Schuko Simon 500 Cima embornamiento por corte 1 click ® con LED	50010432-030	20,61	10
		50010432-038	21,01	
		50010432-037	20,61	
	Base doble Schuko Simon 500 Cima embornamiento a tornillo con LED	50010472-030	20,61	10
		50010472-038	21,01	
		50010472-037	20,61	
	Mecanismo base doble Schuko Simon 500 Cima embornamiento por corte 1 click ®	50002432-039	13,07	10
	Mecanismo base doble Schuko Simon 500 Cima embornamiento a tornillo	50002472-039	13,07	10
	Tapa doble Schuko Simon 500 Cima con LED	50011041-033	8,55	10
		50011041-072	7,00	
		50011041-065	7,00	

ACCESORIOS



	Enlazador para 2 bases eléctricas Simon 500 Cima	50000996-039	2,30	20
	Para cajas de pared y envolventes metálicos.			

BASES ELÉCTRICAS FRANCESAS SIMON 500 CIMA

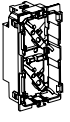

	Base doble francesa Simon 500 Cima embornamiento por corte 1 click ®	50000468-030	16,03	10
		50000468-038	16,36	
		50000468-037	16,03	
	Base doble francesa Simon 500 Cima embornamiento por corte rojo para pin desbloqueo obturador seguridad	50000469-037	19,31	10
	Base doble francesa Simon 500 embornamiento a tornillo sin LED	50000458-030	16,03	10
		50000458-038	16,36	
		50000458-037	16,03	
	Base doble francesa Simon 500 embornamiento a tornillo sin LED para pin desbloqueo obturador seguridad	50000459-037	19,31	10
	Pin para desbloqueo del obturador de seguridad	50000803-039	1,28	20

BASES ELÉCTRICAS SIMON 500 CIMA SIN LED

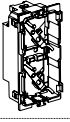
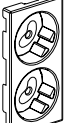
	Base doble Schuko Simon 500 Cima embornamiento por corte 1 click ® sin LED	50000432-030	16,03	10
		50000432-037	16,03	

DESCRIPCIÓN	ARTÍCULO	PRECIO € Recomendado	PIEZAS CAJA
 Base doble Schuko Simon 500 Cima embornamiento a tornillo sin LED	50000472-030	16,03	10
	50000472-037	16,03	
 Mecanismo base doble Schuko Simon 500 Cima embornamiento por corte 1 click 	50002432-039	13,07	10
 Mecanismo base doble Schuko Simon 500 Cima embornamiento a tornillo	50002472-039	13,07	10
 Tapa doble Schuko Simon 500 Cima sin visor ni LED	50001041-038	3,93	10

RECAMBIOS BASES ELÉCTRICAS SIMON 500 CIMA

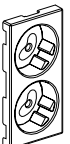
 Recambio LED para base doble Schuko Simon 500 Cima	50000802-039	4,14	10
 Tapa doble schuko Simon 500 Cima con visor sin LED	50011841-030	5,87	10
	50011841-038	6,23	
	50011841-037	5,87	
 Tapa doble Schuko Simon 500 Cima sin visor, sin LED	50001841-030	3,93	10
	50001841-037	3,93	

ELEMENTOS DE PROTECCIÓN SIMON 500 CIMA



PLACAS SIMON 500 CIMA CON ELEMENTO DE PROTECCIÓN INCORPORADO

 Placa con magnetotérmico 16A Simon 500 Cima	50000075-030	26,91	5
	50000075-038	27,06	
Placa con magnetotérmico 10A Simon 500 Cima	50001075-030	25,06	5
	50001075-038	25,19	
Placa con diferencial 30 mA Simon 500 Cima	50002075-030	117,78	5
	50002075-038	117,90	

PLACAS SIMON 500 CIMA CON ELEMENTO DE PROTECCIÓN INCORPORADO PARA CAJAS DE SUELO



 Placa con magnetotérmico 16A Simon 500 Cima	50010075-030	26,91	5
	50010075-038	27,06	
Placa con magnetotérmico 10A Simon 500 Cima	50011075-030	25,06	5
	50011075-038	25,19	
Placa con diferencial 30 mA Simon 500 Cima	50012075-030	117,78	5
	50012075-038	117,90	

PLACAS SIMON 500 CIMA PARA ELEMENTO DE PROTECCIÓN

 Placa para magneto o diferencial Simon 500 Cima	50000074-030	14,61	10
	50000074-038	14,92	
 Placa para magneto o diferencial Simon 500 Cima (para cajas de suelo)	50010074-030	14,61	10
	50010074-038	14,92	







DESCRIPCIÓN	ARTÍCULO	PRECIO € Recomendado	PIEZAS CAJA
-------------	----------	-------------------------	----------------

RECAMBIOS

 Adaptador guia DIN para gama Simon 500 Cima	50000076-039	2,28	10
 Adaptador guia DIN para cajas de suelo Simon 500 Cima	50010076-039	1,98	10

PLACAS SIMON 500 CIMA V&D CON CONECTORES RJ45 SIMON

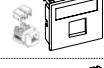



CAT.6A FTP

 Placa Simon 500 Cima V&D inclinada con guardapolvo y con 1 conector Cat.6A FTP	50001081-030	22,90	20
	50001081-038	22,95	
	50001081-033	23,38	
 Placa Simon 500 Cima V&D inclinada con guardapolvo y con 2 conectores Cat.6A FTP	50001086-030	42,39	20
	50001086-038	42,46	
	50001086-033	44,92	
 Placa Simon 500 Cima V&D plana con guardapolvo y con 1 conector Cat.6A FTP	50001085-030	22,84	20
	50001085-038	22,91	
	50001085-033	23,34	
 Placa Simon 500 Cima V&D plana con guardapolvo y con 2 conectores Cat.6A FTP	50001089-030	42,39	20
	50001089-038	42,44	
	50001089-033	44,87	
 Placa Simon 500 Cima V&D plana sin guardapolvo y con 1 conector Cat.6A FTP	50001185-030	20,41	20
 Placa Simon 500 Cima V&D plana sin guardapolvo y con 2 conectores Cat.6A FTP	50001189-030	36,55	20

CAT.6 UTP

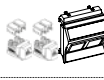
 Placa Simon 500 Cima V&D inclinada con guardapolvo y con 1 conector Cat.6 UTP	50002081-030	17,89	20
	50002081-038	17,94	
	50002081-033	18,30	
 Placa Simon 500 Cima V&D inclinada con guardapolvo y con 2 conectores Cat.6 UTP	50002086-030	32,50	20
	50002086-038	32,56	
	50002086-033	33,17	
 Placa Simon 500 Cima V&D plana con guardapolvo y con 1 conector Cat.6 UTP	50002085-030	17,79	20
	50002085-038	17,86	
	50002085-033	18,20	
 Placa Simon 500 Cima V&D plana con guardapolvo y con 2 conectores Cat.6 UTP	50002089-030	32,40	20
	50002089-038	32,45	
	50002089-033	33,02	
 Placa Simon 500 Cima V&D plana sin guardapolvo y con 1 conector Cat.6 UTP	50002185-030	15,42	20
 Placa Simon 500 Cima V&D plana sin guardapolvo y con 2 conectores Cat.6 UTP	50002189-030	28,85	20

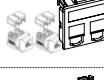
CAT.6 FTP

 Placa Simon 500 Cima V&D inclinada con guardapolvo y con 1 conector Cat.6 FTP	50003081-030	20,88	20
	50003081-038	20,92	
	50003081-033	21,34	
 Placa Simon 500 Cima V&D inclinada con guardapolvo y con 2 conectores Cat.6 FTP	50003086-030	38,63	20
	50003086-038	38,68	
	50003086-033	40,94	
 Placa Simon 500 Cima V&D plana con guardapolvo y con 1 conector Cat.6 FTP	50003085-030	20,84	20
	50003085-038	20,91	
	50003085-033	21,30	
 Placa Simon 500 Cima V&D plana con guardapolvo y con 2 conectores Cat.6 FTP	50003089-030	38,65	20
	50003089-038	38,69	
	50003089-033	40,89	
 Placa Simon 500 Cima V&D plana sin guardapolvo y con 1 conector Cat.6 FTP	50003185-030	18,60	20

CONECTIVIDAD

SIMON 500 CIMA

DESCRIPCIÓN	ARTÍCULO	PRECIO € <small>Recomendado</small>	PIEZAS CAJA
Placa Simon 500 Cima V&D plana sin guardapolvo y con 2 conectores Cat.6 FTP	50003189-030	33,92	20
CAT.5E UTP			
Placa Simon 500 Cima V&D inclinada con guardapolvo y con 1 conector Cat.5e UTP	50004081-030	13,34	20
	50004081-038	13,41	
	50004081-033	13,68	
Placa Simon 500 Cima V&D inclinada con guardapolvo y con 2 conectores Cat.5e UTP	50004086-030	23,41	20
	50004086-038	23,48	
	50004086-033	23,94	
Placa Simon 500 Cima V&D plana con guardapolvo y con 1 conector Cat.5e UTP	50004085-030	13,27	20
	50004085-038	13,33	
	50004085-033	13,59	
Placa Simon 500 Cima V&D plana con guardapolvo y con 2 conectores Cat.5e UTP	50004089-030	23,36	20
	50004089-038	23,80	
	50004089-033	24,34	
Placa Simon 500 Cima V&D plana sin guardapolvo y con 1 conector Cat.5e UTP	50004185-030	10,93	20
Placa Simon 500 Cima V&D plana sin guardapolvo y con 2 conectores Cat.5e UTP	50004189-030	19,78	20

PLACAS SIMON 500 CIMA V&D PARA CONECTORES RJ45

PLACAS V&D INCLINADAS CON GUARDAPOLVO PARA CONECTORES DE OTRAS MARCAS

Placa Simon 500 Cima V&D inclinada con guardapolvo para 1 módulo MD	50000081-030	5,37	20
	50000081-038	5,48	
	50000081-033	6,45	
Placa Simon 500 Cima V&D inclinada con guardapolvo para 2 módulos MD	50000086-030	6,81	20
	50000086-038	6,95	
	50000086-033	8,16	

PLACAS V&D INCLINADAS SIN GUARDAPOLVO PARA CONECTORES DE OTRAS MARCAS

Placa Simon 500 Cima V&D inclinada sin guardapolvo para 1 módulo MD	50000181-030	5,13	20
	50000181-038	5,20	
	50000181-033	6,13	
Placa Simon 500 Cima V&D inclinada sin guardapolvo para 2 módulos MD	50000186-030	6,46	20
	50000186-038	6,58	
	50000186-033	7,76	

MÓDULOS MD PARA PLACAS CIMA INCLINADAS

Módulo MD para 1 conector 3m Volition OCK®	MD45	0,77	50
Módulo MD para 1 conector (R&M)®	MD54	0,77	50
Módulo MD para 1 conector Systimax® (Avaya®)	MD63	0,77	50
Módulo MD para 1 conector Amp®, Krone® o BeldenCDT®	MD64	0,77	50
Módulo MD para 1 conector Amp®, Brand Rex® o Simon Connect®	MD67	0,77	50
Módulo MD para 1 conector BeldenCDT® (Nordx)	MD68	0,77	50

DESCRIPCIÓN	ARTÍCULO	PRECIO € <small>Recomendado</small>	PIEZAS CAJA
Módulo MD para 1 conector Panduit®	MD69	0,77	50
Módulo MD para 1 conector Corning (Siemens®)	MD79	0,77	50
Módulo MD para 1 conector Nexans®	MD85	0,77	50

PLACAS V&D PLANAS CON GUARDAPOLVO PARA CONECTORES V&D DE OTRAS MARCAS

Placa Simon 500 Cima V&D plana con guardapolvo para 1 conector Simon, Amp®, Brand Rex®, Systimax® (Avaya®), Krone® o BeldenCDT®	50000085-030	5,99	20
	50000085-038	6,14	
	50000085-033	7,07	
Placa Simon 500 Cima V&D plana con guardapolvo para 1 conector ITT Cannon®	50016085-030	5,99	10
	50016085-038	6,14	
Placa Simon 500 Cima V&D plana con guardapolvo para 1 conector BeldenCDT® (Nordx®)	50013085-030	5,99	10
	50013085-038	6,14	
	50013085-033	7,07	
Placa Simon 500 Cima V&D plana con guardapolvo para 1 conector Panduit®	50019085-030	5,99	10
	50019085-038	6,14	
Placa Simon 500 Cima V&D plana con guardapolvo para 1 conector Infra+®	50015085-030	5,99	10
	50015085-038	6,14	
Placa Simon 500 Cima V&D plana con guardapolvo para a 1 conector Krone®	50017085-030	5,99	10
	50017085-038	6,14	
	50017085-033	7,05	
Placa Simon 500 Cima V&D plana con guardapolvo para 1 conector Nexans®	50018085-030	5,99	10
	50018085-038	6,14	
	50018085-033	7,05	
Placa Simon 500 Cima V&D plana con guardapolvo para 2 conectores Simon, AMP®, Brand Rex®, Systimax® (Avaya®), Krone® o BeldenCDT®	50000089-030	8,10	20
	50000089-038	8,24	
	50000089-033	9,42	
Placa Simon 500 Cima V&D plana con guardapolvo para 2 conectores ITT Cannon®	50016089-030	8,10	10
	50016089-038	8,24	
Placa Simon 500 Cima V&D plana con guardapolvo para 2 conectores BeldenCDT® (Nordx®)	50013089-030	8,10	10
	50013089-038	8,24	
	50013089-033	9,42	
Placa Simon 500 Cima V&D plana con guardapolvo para 2 conectores Panduit®	50019089-030	8,10	10
	50019089-038	8,24	
Placa Simon 500 Cima V&D plana con guardapolvo para 2 conectores Infra+®	50015089-030	8,10	10
	50015089-038	8,24	
Placa Simon 500 Cima V&D plana con guardapolvo para a 2 conectores Krone®	50017089-030	8,10	10
	50017089-038	8,24	
	50017089-033	9,42	
Placa Simon 500 Cima V&D plana con guardapolvo para 2 conectores Nexans®	50018089-030	8,10	10
	50018089-038	8,24	
	50018089-033	9,42	

PLACAS V&D PLANAS SIN GUARDAPOLVO PARA CONECTORES DE OTRAS MARCAS

Placa Simon 500 Cima V&D plana sin guardapolvo para 1 - 2 conectores Siemon®	50021186-030	7,28	10
Placa Simon 500 Cima V&D plana sin guardapolvo para 1 conector Simon, Amp®, Brand Rex®, Systimax® (Avaya®), Krone® o BeldenCDT®	50000185-030	3,50	20
	50000185-038	3,56	
	50000185-033	5,19	
Placa Simon 500 Cima V&D plana sin guardapolvo para 1 conector Panduit®	50019185-030	3,50	10
	50019185-038	3,56	
Placa Simon 500 Cima V&D plana sin guardapolvo para 1 conector Infra+®	50015185-030	3,50	10
	50015185-038	3,56	
Placa Simon 500 Cima V&D plana sin guardapolvo para 1 conector Nexans®	50018185-030	3,50	10
	50018185-038	3,56	
	50018185-033	5,19	
Placa Simon 500 Cima V&D plana sin guardapolvo para 1 conector 3m Volition OCK®	50011185-030	3,50	10
	50011185-038	3,56	
Placa Simon 500 Cima V&D plana sin guardapolvo para 1 conector (R&M)®	50020185-030	3,50	10
	50020185-038	3,56	
	50020185-033	5,19	

DESCRIPCIÓN

ARTÍCULO
Recomendado

PRECIO €

PIEZAS
CAJA

	Placa Simon 500 Cima V&D plana sin guardapolvo para 2 conectores Simon, Amp®, Brand Rex®, Systimax® (Avaya®), Krone® o BeldenCDT®	50000189-030	4,17	20
		50000189-038	4,26	
		50000189-033	6,19	
	Placa Simon 500 Cima V&D plana sin guardapolvo para 2 conectores 3m Volition OCK®	50011189-030	4,17	10
		50011189-038	4,26	
	Placa Simon 500 Cima V&D plana sin guardapolvo para 2 conectores Panduit®	50019189-030	4,17	10
		50019189-038	4,26	
	Placa Simon 500 Cima V&D plana sin guardapolvo para 2 conectores Infra+®	50015189-030	4,17	10
		50015189-038	4,26	
	Placa Simon 500 Cima V&D plana sin guardapolvo para 2 conectores Nexans®	50018189-030	4,17	10
		50018189-038	4,26	
		50018189-033	6,19	

PLACAS SIMON 500 CIMA ADAPTADORAS

PLACAS SIMON 500 CIMA PARA MECANISMOS SIMON K45

	Placa adaptadora individual Simon 500 Cima para mecanismos K45	50012088-030	2,26	10
		50012088-038	2,34	
		50012088-033	3,42	

PLACAS SIMON 500 CIMA PARA MECANISMOS SIMON 27

	Placa adaptadora individual Simon 500 Cima para mecanismos Simon 27	50010088-030	2,26	10
		50010088-038	2,34	
	Placa adaptadora Cima individual Simon 500 para mecanismos electronicos Simon 27	50011088-030	4,47	10
		50011088-038	4,58	
	Placa adaptadora doble Simon 500 Cima para mecanismos Simon 27 clipaje vertical	50000088-030	4,47	10
		50000088-038	4,58	
		50000088-033	6,19	

PLACAS CIEGAS SIMON 500 CIMA

	Placa ciega doble Simon 500 Cima	50000800-030	5,72	10
		50000800-038	5,80	
		50000800-033	7,42	
	Placa ciega individual Simon 500 Cima	50010800-030	2,88	10
		50010800-038	2,93	
		50010800-033	3,71	

CAJAS DE PARED SUPERFICIE SIMON 500 CIMA

CAJAS

	Caja de pared superficie Simon 500 Cima de 1 módulo	51000001-030	17,96	1
		51000001-038	18,33	
		51000001-033	43,84	
	Caja de pared superficie Simon 500 Cima de 2 módulos	51000002-030	23,67	1
		51000002-038	24,15	
		51000002-033	55,13	
	Caja de pared superficie Simon 500 Cima de 3 módulos	51000003-030	31,40	1
		51000003-038	32,02	
		51000003-033	61,56	
	Caja de pared superficie Simon 500 Cima de 4 módulos	51000004-030	38,07	1
		51000004-038	38,80	
		51000004-033	68,03	
	Caja de pared superficie Simon 500 Cima de 6 módulos	51000006-030	50,65	1
		51000006-038	51,68	
		51000006-033	90,60	

DESCRIPCIÓN

ARTÍCULO

PRECIO €
Recomendado

PIEZAS
CAJA

CAJAS CON TAPA

	Caja de pared superficie con tapa Simon 500 Cima de 3 módulos	51040003-030	35,59	1
		51040003-038	39,83	
		51040003-033	85,24	
	Caja de pared superficie con tapa Simon 500 Cima de 4 módulos	51040004-030	42,94	1
		51040004-038	43,78	
		51040004-033	112,71	

ACCESORIOS

	Amplificador de profundidad Simon 500 Cima para caja de pared de 3 módulos	51030903-030	11,46	1
		51030903-038	11,68	
		51030903-033	17,17	
	Amplificador de profundidad Simon 500 Cima para caja de pared de 4 módulos	51030904-030	15,92	1
		51030904-038	16,25	
		51030904-033	23,88	
	Adaptador Simon 500 Cima para entrada de minicanal de 20x30mm.	51010900-030	2,21	10
		51020900-030	2,95	10
	Adaptador Simon 500 Cima para entrada de minicanal de 20x50mm.	51020900-030	2,95	10
		51030900-030	2,65	5
	Adaptador Simon 500 Cima para entrada de tubo o prensaestopa 22mm	51030900-030	2,65	5
		51040900-033	8,93	1
	Bombin y llave Simon 500 Cima para marco con tapa	51040900-033	8,93	1
		51040905-030	1,45	10

RECAMBIOS

	Bastidor Simon 500 Cima	50000801-039	1,52	10
--	-------------------------	--------------	------	----

CAJAS DE PARED EMPOTRAR SIMON 500 CIMA

CAJETÍN DE EMPOTRAR EMBALAJE INDIVIDUAL

	Cajetín de empotrar Simon 500 Cima de 1 módulo	51020101-039	9,61	1
	Cajetín de empotrar Simon 500 Cima de 2 módulos	51020102-039	12,80	1
	Cajetín de empotrar Simon 500 Cima de 3 módulos	51020103-039	16,05	1
	Cajetín de empotrar Simon 500 Cima de 4 módulos	51020104-039	20,27	1
	Cajetín de empotrar Simon 500 Cima de 6 módulos	51020106-039	25,30	1

CAJETÍN DE EMPOTRAR EMBALAJE MÚLTIPLE

	Cajetín de empotrar Simon 500 Cima de 1 módulo	51020701-039	9,31	10
	Cajetín de empotrar Simon 500 Cima de 2 módulos	51020702-039	12,36	10
	Cajetín de empotrar Simon 500 Cima de 3 módulos	51020703-039	15,59	10
	Cajetín de empotrar Simon 500 Cima de 4 módulos	51020704-039	19,55	10
	Cajetín de empotrar Simon 500 Cima de 6 módulos	51020706-039	24,43	10

MARCOS Y BASTIDORES

	Marco y bastidores Simon 500 Cima para cajetín de pared empotrar de 1 módulo	51010101-030	9,76	10
		51010101-038	9,97	
		51010101-033	18,16	
	Marco y bastidores Simon 500 Cima para cajetín de pared empotrar de 2 módulos	51010102-030	15,33	10
		51010102-038	15,65	
		51010102-033	28,47	
	Marco y bastidores Simon 500 Cima para cajetín de pared empotrar de 3 módulos	51010103-030	19,25	10
		51010103-038	19,63	
		51010103-033	37,99	

CONECTIVIDAD

SIMON 500 CIMA

DESCRIPCIÓN	ARTÍCULO	PRECIO € <small>Recomendado</small>	PIEZAS CAJA
	51010104-030	22,05	5
	51010104-038	22,46	
	51010104-033	47,48	
Marco y bastidores Simon 500 Cima para cajetín de pared empotrar de 6 módulos	51010106-030	28,25	5
	51010106-038	28,79	
	51010106-033	60,72	

MARCOS Y BASTIDORES CON TAPA

	51040103-030	23,40	1
	51040103-038	23,88	
	51040103-033	61,68	
Marco con tapa y bastidores Simon 500 Cima para cajetín de pared empotrar de 4 módulos	51040104-030	26,94	1
	51040104-038	27,47	
	51040104-033	69,58	

ACCESORIOS

	51030903-030	11,46	1
	51030903-038	11,68	
	51030903-033	17,17	
Amplificador de profundidad Simon 500 Cima para caja de pared de 4 módulos	51030904-030	15,92	1
	51030904-038	16,25	
	51030904-033	23,88	
	51040900-033	8,93	1

RECAMBIOS

	50000801-039	1,52	10
--	--------------	------	----

CAJAS DE SUELO SIMON 500 CIMA PROFUNDIDAD REDUCIDA

	52050202-035	60,69	1
	52050203-035	65,98	1
	52050204-035	71,46	1

TAPA EMBELLECEDORA

	52053202-035	7,66	1
	52053203-035	9,11	1
	52053204-035	9,98	1

CUBETAS PARA CAJAS DE SUELO DE PROFUNDIDAD REDUCIDA EN PAVIMENTO

	G201	26,83	1
	G301C	28,10	1
	G401	35,20	1

DESCRIPCIÓN	ARTÍCULO	PRECIO € <small>Recomendado</small>	PIEZAS CAJA
CAJA DE SUELO SIMON 500 CIMA			

CAJAS DE SUELO PARA SUELO TÉCNICO SIMON 500 CIMA (PROFUNDIDAD REGULABLE 90 A 120 MM.) INCLUYEN MARCO PORTAMECANISMOS EN -030

	52050101-035	49,57	1
	52050101-038	49,57	
Caja de suelo Simon 500 Cima profundidad: 90mm 2 módulos	52050102-035	63,08	1
	52050102-038	63,08	
Caja de suelo Simon 500 Cima .profundidad: 90mm 3 módulos	52050103-035	74,07	1
	52050103-038	74,07	
Caja de suelo Simon 500 Cima profundidad: 90mm 4 módulos	52050104-035	85,11	1
	52050104-038	85,11	
Caja de suelo Simon 500 Cima profundidad: 90mm 6 módulos	52050106-035	107,33	1
	52050106-038	107,33	

CAJA DE SUELO METÁLICA

		52050002-036	310,99	1
		52050003-036	371,00	1
		52050004-036	427,71	1
		KGH401/8	124,90	1
		KGH601/8	139,90	1
Cubeta de suelo metálica pavimento 6 módulos 45x45mm / 3 módulos 50x100mm		KGH801/8	158,95	1
		KGH801/8	158,95	1

CAJAS DE SUELO PARA PAVIMENTO SIMON 500 CIMA (PROFUNDIDAD REGULABLE 70 A 100 MM.) INCLUYEN MARCO PORTAMECANISMOS EN -030

	52050001-035	48,77	1
	52050001-038	48,77	
Caja de suelo Simon 500 Cima profundidad: 70mm 2 módulos	52050002-035	61,91	1
	52050002-038	61,91	
Caja de suelo Simon 500 Cima profundidad: 70mm 3 módulos	52050003-035	72,88	1
	52050003-038	72,88	
Caja de suelo Simon 500 Cima . profundidad: 70mm 4 módulos	52050004-035	81,24	1
	52050004-038	81,24	
Caja de suelo Simon 500 Cima . profundidad: 70mm 6 módulos	52050006-035	101,54	1
	52050006-038	101,54	

MARCOS PORTAMECANISMOS PARA CAJAS DE SUELO

	52051801-030	6,02	10
	52051801-038	6,17	
Marco portamecanismos Simon 500 Cima de 2 módulos	52051802-030	9,16	10
	52051802-038	9,36	
Marco portamecanismos Simon 500 Cima de 3 módulos	52051803-030	11,99	10
	52051803-038	12,25	
Marco portamecanismos Simon 500 Cima de 4 módulos	52051804-030	15,03	5
	52051804-038	15,33	





DESCRIPCIÓN

ARTÍCULO PRECIO € PIEZAS CAJA
Recomendado

DESCRIPCIÓN

ARTÍCULO PRECIO € PIEZAS CAJA
Recomendado

TAPAS EMBELLECEDORAS DE ENRASAMIENTO PARA CAJAS DE SUELO

	Tapa embellecedora de enrasamiento Simon 500 Cima para caja de suelo 1 módulo	52053101-035	6,33	10
		52053101-038	6,33	
	Tapa embellecedora de enrasamiento Simon 500 Cima para caja de suelo 2 módulos	52053102-035	8,20	10
		52053102-038	8,20	
	Tapa embellecedora de enrasamiento Simon 500 Cima para caja de suelo 3 módulos	52053103-035	9,86	10
		52053103-038	9,86	
	Tapa embellecedora de enrasamiento Simon 500 Cima para caja de suelo 4 módulos	52053104-035	10,78	10
		52053104-038	10,78	
	Tapa embellecedora de enrasamiento Simon 500 Cima para caja de suelo 6 módulos	52053106-035	16,92	10
		52053106-038	16,92	

REGISTROS DE SUELO SIMON 500 CIMA

Para el acceso y mantenimiento de la instalación





TAPAS DE REGISTRO SIMON 500 CIMA (NO ADMITE MECANISMOS) Y PASACABLES

	Tapa de registro Simon 500 Cima de 1 módulo para suelo técnico o mediante cubeta para pavimento	52054101-035	38,36	1
		52054101-038	38,36	
	Tapa de registro Simon 500 Cima de 2 módulos para suelo técnico o mediante cubeta para pavimento	52054102-035	44,57	1
		52054102-038	44,57	
	Tapa de registro Simon 500 Cima de 3 módulos para suelo técnico o mediante cubeta para pavimento	52054103-035	50,16	1
		52054103-038	50,16	
	Tapa de registro Simon 500 Cima de 4 módulos para suelo técnico o mediante cubeta para pavimento	52054104-035	54,72	1
		52054104-038	54,72	
	Tapa de registro Simon 500 Cima de 6 módulos para suelo técnico o mediante cubeta para pavimento	52054106-035	64,83	1
		52054106-038	64,83	
	Salida de cables Simon 500 Cima Ø102mm para mesa o suelo técnico	52055000-030	11,93	5
		52055000-038	12,17	
		52055000-033	24,25	

CUBETA PLÁSTICO PARA CAJAS DE SUELO PAVIMENTO (PROFUNDIDAD REGULABLE 80 A 115 MM.)

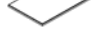
	Cubeta de plástico regulable para pavimento para tapa de registro 1 módulo	52052101-035	31,09	1
	Cubeta de plástico regulable para pavimento para tapa de registro 2 módulos	52052102-035	31,09	1
	Cubeta de plástico regulable para pavimento para tapa de registro 3 módulos	52052103-035	35,04	1
	Cubeta de plástico regulable para pavimento para tapa de registro 4 módulos	52052104-035	40,28	1
	Cubeta de plástico regulable para pavimento para tapa de registro 6 módulos	52052106-035	45,28	1

TAPAS EMBELLECEDORAS DE ENRASAMIENTO SIMON CIMA 500

	Tapa embellecedora para Tapa de registro 1 módulo	52053101-035	6,33	10
		52053101-038	6,33	
	Tapa embellecedora para Tapa de registro 2 módulos	52053102-035	8,20	10
		52053102-038	8,20	
	Tapa embellecedora para Tapa de registro 3 módulos	52053103-035	9,86	10
		52053103-038	9,86	
	Tapa embellecedora para Tapa de registro 4 módulos	52053104-035	10,78	10
		52053104-038	10,78	
	Tapa embellecedora para Tapa de registro 6 módulos	52053106-035	16,92	10
		52053106-038	16,92	



CUBETA METÁLICA PARA CAJAS DE SUELO PAVIMENTO (PROFUNDIDAD REGULABLE 73 A 98 MM.)

	Cubeta metálica regulable para pavimento para tapa de registro 3 módulos	52052203-033	129,23	1
	Cubeta metálica regulable para pavimento para tapa de registro 4 módulos	52052204-033	133,83	1
	Cubeta metálica regulable para pavimento para tapa de registro 6 módulos	52052206-033	168,78	1

CUBETA PLÁSTICO PARA PAVIMENTO CONEXIÓN FINAL (PROFUNDIDAD REGULABLE 80 A 115 MM.)

	Cubeta plástico regulable para pavimento para cajas de suelo Simon 500 Cima 1 módulo	52052101-035	31,09	1
	Cubeta plástico regulable para pavimento para cajas de suelo Simon 500 Cima 2 módulos	52052102-035	31,09	1
	Cubeta plástico regulable para pavimento para cajas de suelo Simon 500 Cima 3 módulos	52052103-035	35,04	1
	Cubeta plástico regulable para pavimento para cajas de suelo Simon 500 Cima 4 módulos	52052104-035	40,28	1
	Cubeta plástico regulable para pavimento para cajas de suelo Simon 500 Cima 5 módulos	52052106-035	45,28	1

RECAMBIOS CAJAS DE SUELO



	Tapa abatible para caja de suelo Simon 500 Cima 1 módulo	RSF001/1	28,56	1
		RSF001/14	28,56	
	Tapa abatible para caja de suelo Simon 500 Cima 2 módulos	RSF002/1	31,28	1
		RSF002/14	31,28	
	Tapa abatible para caja de suelo Simon 500 Cima 3 módulos	RSF003/1	33,88	1
		RSF003/14	33,88	
	Tapa abatible para caja de suelo Simon 500 Cima 4 módulos	RSF004/1	35,63	1
		RSF004/14	35,63	
	Tapa abatible para caja de suelo Simon 500 Cima 6 módulos	RSF006/1	41,75	1
		RSF006/14	41,75	

CUBETA METÁLICA PARA PAVIMENTO PARA REALIZAR DERIVACIONES (PROFUNDIDAD REGULABLE 73 A 98 MM.)

	Cubeta metálica regulable para pavimento para cajas de suelo Simon 500 Cima 3 módulos	52052203-033	129,23	1
	Cubeta metálica regulable para pavimento para cajas de suelo Simon 500 Cima 4 módulos	52052204-033	133,83	1
	Cubeta metálica regulable para pavimento para cajas de suelo Simon 500 Cima 6 módulos	52052206-033	168,78	1

CONECTIVIDAD

SIMON 500 CIMA

DESCRIPCIÓN	ARTÍCULO	PRECIO € Recomendado	PIEZAS CAJA
TORRETAS DE SUELO SIMON 500 CIMA			
 Torreta Simon 500 Cima de 2 módulos/cara	52550204-030	48,46	1
 Zócalo para torreta Simon 500 Cima, acceso canal de suelo 85x18mm	52554204-030	18,20	1

MINICOLUMNAS DE SUELO SIMON 500 CIMA

Incluye perfil, zócalo, embellecedor y tapa superior en una única referencia

MINICOLUMNAS SIMON 500 CIMA 1 CARA			
 Minicolumna Simon 500 Cima 1 cara de 2 módulos	52550112-030	96,44	1
	52550112-033	96,44	
Minicolumna Simon 500 Cima 1 cara de 3 módulos	52550113-030	107,86	1
	52550113-033	107,86	
Minicolumna Simon 500 Cima 1 cara de 4 módulos	52550114-030	119,32	1
	52550114-033	119,32	
Minicolumna Simon 500 Cima 1 cara de 5 módulos	52550115-030	130,71	1
	52550115-033	130,71	





MINICOLUMNAS SIMON 500 CIMA 2 CARAS			
 Minicolumna Simon 500 Cima 2 caras de 2 módulos/cara	52550222-030	133,59	1
	52550222-033	133,59	
Minicolumna Simon 500 Cima 2 caras de 3 módulos/cara	52550223-030	156,95	1
	52550223-033	156,95	
Minicolumna Simon 500 Cima 2 caras de 4 módulos/cara	52550224-030	179,85	1
	52550224-033	179,85	
Minicolumna Simon 500 Cima 2 caras de 5 módulos/cara	52550225-030	202,88	1
	52550225-033	202,88	

Para instalación de Mecanismos SIMON 500 CIMA es necesario bastidor y marco ref. 52550900-...

ACCESORIOS PARA LA INSTALACIÓN DE MÓDULOS SIMON 500 CIMA

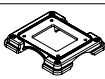
 Marco embellecedor y bastidor Simon 500 Cima	52550900-030	4,00	10
	52550900-038	4,07	
	52550900-033	9,77	

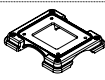
RECAMBIOS PARA MINICOLUMNAS SIMON 500 CIMA

 Zócalo individual minicolumna y columna Simon 500 Cima 1 cara	52551803-038	11,90	1
 Embellecedor individual para minicolumna y columna Simon 500 Cima 1 cara	52551801-030	13,68	1
	52551801-038	13,94	
 Tapa superior minicolumna Simon 500 Cima 1 cara	52551805-030	8,19	5
	52551805-038	8,34	
 Zócalo doble minicolumna y columna Simon 500 Cima 2 caras	52551804-038	15,36	1
 Embellecedor doble para minicolumna y columna Simon 500 Cima 2 caras	52551802-030	13,68	1
	52551802-038	13,94	
 Tapa superior minicolumna Simon 500 Cima 2 caras	52551806-030	9,49	5
	52551806-038	9,72	

COLUMNAS SIMON 500 CIMA



Incluye el perfil con tapa, sistema de fijación por presión, zócalo y embellecedores de techo y suelo en una única referencia

COLUMNAS SIMON 500 CIMA 1 CARA			
 Columna Simon 500 Cima 1 cara. longitud del perfil 3m longitud del soporte de fijación: 1,5m	53550101-030	478,68	1
	53550101-033	478,68	

COLUMNAS SIMON 500 CIMA 2 CARAS			
 Columna Simon 500 Cima 2 caras. longitud del perfil 3m longitud del soporte de fijación: 1,5m	53550201-030	733,80	1
	53550201-033	733,80	

Para instalación de Mecanismos SIMON 500 CIMA es necesario bastidor y marco ref. 52550900-...





PROLONGACIÓN COLUMNAS SIMON 500 CIMA

 Prolongación columna Simon 500 Cima 1 cara de 0,5m	53555101-030	72,10	1
	53555101-033	72,10	
Prolongación columna Simon 500 Cima 1 cara de 1m	53555102-030	144,10	1
	53555102-033	144,10	
Prolongación columna Simon 500 Cima 1 cara de 1,5m	53555103-030	271,26	1
	53555103-033	271,26	
 Prolongación columna Simon 500 Cima 2 caras de 0,5m	53555201-030	114,29	1
	53555201-033	114,29	
Prolongación columna Simon 500 Cima 2 caras de 1m	53555202-030	228,57	1
	53555202-033	228,57	
Prolongación columna Simon 500 Cima 2 caras de 1,5m	53555203-030	420,99	1
	53555203-033	420,99	

ACCESORIOS PARA LA INSTALACIÓN DE MECANISMOS EN COLUMNAS SIMON 500 CIMA

 Marco y bastidor Simon 500 Cima	52550900-030	4,00	10
	52550900-038	4,07	
	52550900-033	9,77	

RECAMBIOS PARA COLUMNAS SIMON 500 CIMA

 Zócalo individual minicolumna y columna Simon 500 Cima 1 cara	52551803-038	11,90	1
 Embellecedor individual para minicolumna y columna Simon 500 Cima 1 cara	52551801-030	13,68	1
	52551801-038	13,94	
 Zócalo doble minicolumna y columna Simon 500 Cima 2 caras	52551804-038	15,36	1
 Embellecedor doble para minicolumna y columna Simon 500 Cima 2 caras	52551802-030	13,68	1
	52551802-038	13,94	
 Tapa frontal 3m para columnas Simon 500 Cima	52551807-030	89,02	1
	52551807-033	89,02	

DESCRIPCIÓN

ARTÍCULO PRECIO € PIEZAS CAJA
Recomendado

DESCRIPCIÓN

ARTÍCULO PRECIO € PIEZAS CAJA
Recomendado

ENVOLVENTES METÁLICOS SIMON 500 CIMA

CAJAS DE SUPERFICIE SIMON 500 CIMA

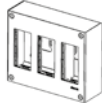
	Caja metálica de superficie Simon 500 Cima de 1 módulo	51000011-036	48,65	1
	Caja metálica de superficie Simon 500 Cima de 2 módulos	51000012-036	64,65	1
	Caja metálica de superficie Simon 500 Cima de 3 módulos	51000013-036	86,07	1
	Caja metálica de superficie Simon 500 Cima de 4 módulos	51000014-036	104,28	1
	Caja metálica de superficie Simon 500 Cima de 6 módulos	51000016-036	130,17	1

CAJAS DE EMPOTRAR SIMON 500 CIMA

	Caja metálica de empotrar Simon 500 Cima de 1 módulo	51000111-036	61,99	1
	Caja metálica de empotrar Simon 500 Cima de 2 módulos	51000112-036	77,09	1
	Caja metálica de empotrar Simon 500 Cima de 3 módulos	51000113-036	95,80	1
	Caja metálica de empotrar Simon 500 Cima de 4 módulos	51000114-036	114,52	1
	Caja metálica de empotrar Simon 500 Cima de 6 módulos	51000116-036	136,95	1



TORRETAS 1 CARA SIMON 500 CIMA

	Torreta metálica Simon 500 Cima 1 cara de 2 módulos	52510212-036	108,93	1
	Torreta metálica Simon 500 Cima 1 cara de 3 módulos	52510213-036	123,89	1
	Torreta metálica Simon 500 Cima 1 cara de 4 módulos	52510214-036	140,89	1
	Torreta metálica Simon 500 Cima 1 cara de 5 módulos	52510215-036	160,26	1

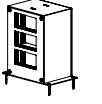
TORRETAS 2 CARAS SIMON 500 CIMA

	Torreta metálica Simon 500 Cima 2 caras de 2 módulos/cara	52510222-036	146,98	1
	Torreta metálica Simon 500 Cima 2 caras de 3 módulos/cara	52510223-036	164,43	1
	Torreta metálica Simon 500 Cima 2 caras de 4 módulos/cara	52510224-036	187,87	1

ACCESORIOS



	Tapa protectora con bombín para cajas de superficie y empotrar metálicas de 3 módulos	51040013-036	74,22	1
	Tapa protectora con bombín para cajas de superficie y empotrar metálicas de 4 módulos	51040014-036	81,98	1
	Tapa protectora con bombín para torreta metálica de 4 módulos	52513214-036	81,98	1



Simon | K45

TELEBLOCK K45

TELEBLOCK K45 MONTADO Y CABLEADO

	Pack Teleblock K45 elevación automática con 2 bases eléctricas K45 grafito, 2 bases eléctricas K45 rojas y 2 conectores RJ45 Cat.6 UTP, 2 latiguillos eléctricos 3x2,5mm2 de 2m con clavija Schuko y 2 latiguillos de voz y datos de 2m.	KTLE216U	334,34	1
	Pack Teleblock con 2 bases eléctricas K45 grafito, 2 bases eléctricas K45 rojas, 2 conectores RJ45 Cat.6 UTP, 2 latiguillos eléctricos 2x2,5mm2 de 2m con clavija Schuko y 2 latiguillos de voz y datos de 2m.	KTL216U	278,43	1
	Pack Teleblock cuisine con 2 bases eléctricas K45 grafito y 1 latiguillo eléctrico 3x2,5mm2 de 2m con clavija Schuko.	KTL212	140,05	1

Se debe completar el TELEBLOCK K45 con la Tapa y el Marco Embellecedor Ref. KTLA1/..

TELEBLOCK K45 PARA CONFIGURAR

	Teleblock K45 para 5 mecanismos útiles K45 . elevación automática	KTLE205	181,80	1
	Teleblock K45 para 2 mecanismos útiles K45 . elevación manual	KTL202	95,44	1
	Teleblock K45 para 3 mecanismos útiles K45 . elevación manual	KTL203	98,49	1
	Teleblock K45 para 4 mecanismos útiles K45 . elevación manual	KTL204	101,53	1
	Teleblock K45 para 5 mecanismos útiles K45 . elevación manual	KTL205	104,54	1
	Teleblock K45 para 6 mecanismos útiles K45 . elevación manual	KTL206	107,57	1

Se debe completar el TELEBLOCK K45 con la Tapa y el Marco Embellecedor Ref. KTLA1/..





TAPA Y MARCO EMBELLECEDOR

	Tapa y marco embellecedor para Teleblock K45 KTL2... y KTLE2...	KTLA1/31	36,80	1
		KTLA1/14	18,22	





DESCRIPCIÓN

ARTÍCULO PRECIO € PIEZAS CAJA
Recomendado

SOPORTES DE FIJACIÓN

	SopORTE Ofiblock K45 fijación individual o bajo mesa	KSF1	9,16	1
	SopORTE Ofiblock K45 fijación tandem bajo suelo técnico	KSF2	14,64	1
	SopORTE Ofiblock K45 fijación sobre mesa	KSF3	30,12	1
	SopORTE Ofiblock K45 fijación carril DIN	KSF5	11,16	1
	SopORTE Ofiblock K45 fijación con imán (se requieren 2 uds)	KSF6	33,67	2



ACCESORIOS Y COMPLEMENTOS DE INSTALACIÓN

	Latiguillo eléctrico Schuko-IEC320 hembra 2m	KTL8/14	6,02	1
	Organizador de cableado de ø25mm y 2m de longitud	TC250/0	37,89	1
	Salida de cables ø102mm para mesa o suelo técnico	TS10/8 TS10/14	22,16 11,12	5
	Latiguillo conexión rápida hembra-Schuko 3 polos. 2 m cable RZ-0,6/1Kv. libre de halógenos. sección 3x2,5 mm2	CR6020/6 CR6020/9 CR6020/14	22,59 22,52 22,52	5
	Latiguillo conexión rápida hembra-extremo libre 3 polos. 2 m cable RZ-0,6/1Kv. libre de halógenos. sección 3x2,5 mm2	CR4020/6 CR4020/9 CR4020/14	19,13 18,68 18,68	5

Más Latiguillos de Conexión Rápida en la página 123



OFIBLOCK COMPACT K45

TAPAS DE ENTRADA LATERAL MODULARES







	Tapa lateral ciega Ofiblock Compact	KCFC01/24	2,98	20
	Tapa lateral cable combinado individual	KCFC02/24	4,08	20
	Tapa lateral entrada CR simple O.Compact	KCFC03/24	2,98	20

DESCRIPCIÓN



ARTÍCULO PRECIO € PIEZAS CAJA
Recomendado

	Tapa lateral entrada CR doble O.Compact	KCFC04/24	2,98	20
	Tapa lateral entrada cable indiv. y CR	KCFC05/24	2,98	20
	Tapa lateral cable combinado RJ45 dual	KCFC06/24	4,43	20

SOPORTES DE FIJACIÓN

	SopORTE Ofiblock fijación individual o bajo mesa	KSF1	9,16	1
	SopORTE Ofiblock fijación tandem bajo suelo técnico	KSF2	14,64	1
	SopORTE Ofiblock fijación sobre mesa	KSF3	30,12	1
	SopORTE Ofiblock Compact fijación mural (se requieren 2 uds)	KSF4	6,14	10
	SopORTE Ofiblock fijación carril DIN	KSF5	11,16	1
	SopORTE Ofiblock fijación con imán (se requieren 2 uds)	KSF6	33,67	2

ACCESORIOS Y COMPLEMENTOS DE INSTALACIÓN

	Organizador de cableado de ø25mm y 2m de longitud	TC250/0	37,89	1
	Salida de cables ø102mm para mesa o suelo técnico	TS10/8 TS10/14	22,16 11,12	5

OFIBLOCK LINE K45



	Ofiblock Line K45 para 1 mecanismo K45	KSF131/8	41,35	1
	Ofiblock Line K45 para 2 mecanismos K45	KSF132/8	45,30	1
	Ofiblock Line K45 para 4 mecanismos K45	KSF134/8	49,64	1
	Ofiblock Line K45 para 6 mecanismos K45	KSF136/8	54,39	1

OFIBLOCK K45 CON SALIDA DE CABLES POSTERIOR







	Ofiblock K45 1 mec. K45 2 sal cab.post.	KFC231/14	18,30	1
	Ofiblock K45 2 mec. K45 2 sal cab.post.	KFC232/14	21,76	1

CONECTIVIDAD









SIMON K45



DESCRIPCIÓN	ARTÍCULO	PRECIO € <small>Recomendado</small>	PIEZAS CAJA
 Ofiblock K45 4 mec. K45 4 sal cab.post.	KFC234/14	25,70	1
 Ofiblock K45 6 mec. K45 4 sal cab.post.	KFC236/14	29,78	1

OFIBLOCK K45 COMPACT SCHUKO















 Ofiblock Compact 2 schukos+1 troquel LP	KFC103020LP1/9 KFC103020LP1/14	51,78 52,35	1 1
 Ofiblock Compact 2 schukos+2 troquel LP	KFC104020LP2/9 KFC104020LP2/14	54,14 54,70	1 1
 Ofiblock Compact 3 schukos+1 troquel LP	KFC104030LP1/9 KFC104030LP1/14	59,98 60,64	1 1
 Ofiblock Compact 2 schukos+2 SAI+1 troq.	KFC105022LP1/9 KFC105022LP1/14	85,64 86,53	1 1
 Ofiblock Compact 4 schukos+1 troquel LP	KFC105040LP1/9 KFC105040LP1/14	68,16 68,94	1 1
 Ofiblock Compact 4 schukos+2 troquel LP	KFC106040LP2/9 KFC106040LP2/14	70,50 71,29	1 1

OFIBLOCK K45 COMPACT ELEMENTS



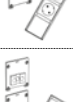
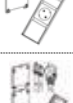

 Ofiblock Compact 3 elem. c/1 troquel LP	KFC103LP1/9 KFC103LP1/14	22,15 22,38	1 1
 Ofiblock Compact 4 elem. c/1 troquel LP	KFC104LP1/9 KFC104LP1/14	23,95 24,17	1 1
 Ofiblock Compact 4 elem. c/2 troquel LP	KFC104LP2/9 KFC104LP2/14	26,19 26,44	1 1
 Ofiblock Compact 4 elem. c/1 troquel NL	KFC104NL1/9 KFC104NL1/14	27,08 27,35	1 1
 Ofiblock Compact 5 elem. c/1 troquel LP	KFC105LP1/9 KFC105LP1/14	25,95 26,21	1 1
 Ofiblock Compact 5 elem. c/2 troquel NL	KFC105NL2/9 KFC105NL2/14	32,46 32,76	1 1
 Ofiblock Compact 6 elem. c/2 troquel LP	KFC106LP2/9 KFC106LP2/14	30,10 30,39	1 1
 Ofiblock Compact 6 elem. c/1 troquel NL	KFC106NL1/9 KFC106NL1/14	31,00 31,29	1 1
 Ofiblock Compact 7 elem. c/1 troquel LP	KFC107LP1/9 KFC107LP1/14	29,80 30,10	1 1



DESCRIPCIÓN	ARTÍCULO	PRECIO € <small>Recomendado</small>	PIEZAS CAJA
 Ofiblock Compact 7 elem. c/2 troquel NL	KFC107NL2/9 KFC107NL2/14	36,31 36,67	1 1
 Ofiblock Compact 8 elem. c/2 troquel LP	KFC108LP2/9 KFC108LP2/14	34,05 34,38	1 1





OFIBLOCK K45 COMPACT ELEMENTS 45X45MM

 Ofiblock Compact 2 elementos 45x45mm bl.	KFC202/9	18,38	1
 Ofiblock Compact 2 elementos 45x45mm gf.	KFC202/14	18,59	1
 Ofiblock Compact 3 elementos 45x45mm bl.	KFC203/9	19,91	1
 Ofiblock Compact 3 elementos 45x45mm gf.	KFC203/14	20,16	1
 Ofiblock Compact 4 elementos 45x45mm bl.	KFC204/9	21,71	1
 Ofiblock Compact 4 elementos 45x45mm gf.	KFC204/14	21,96	1
 Ofiblock Compact 5 elementos 45x45mm bl.	KFC205/9	23,70	1
 Ofiblock Compact 5 elementos 45x45mm gf.	KFC205/14	24,00	1
 Ofiblock Compact 6 elementos 45x45mm bl.	KFC206/9	25,61	1
 Ofiblock Compact 6 elementos 45x45mm gf.	KFC206/14	25,92	1
 Ofiblock Compact 7 elementos 45x45mm bl.	KFC207/9	27,56	1
 Ofiblock Compact 7 elementos 45x45mm gf.	KFC207/14	27,88	1
 Ofiblock Compact 8 elementos 45x45mm bl.	KFC208/9	29,56	1
 Ofiblock Compact 8 elementos 45x45mm gf.	KFC208/14	29,86	1
 Ofiblock Compact 9 elementos 45x45mm bl.	KFC209/9	31,55	1
 Ofiblock Compact 9 elementos 45x45mm gf.	KFC209/14	31,91	1
Ofiblock Compact 10 elementos 45x45mm bl.	KFC210/9	33,66	1
Ofiblock Compact 10 elementos 45x45mm gf.	KFC210/14	34,02	1



PACKS OFIBLOCK

 Pack Ofiblock 1 base eléctrica Schuko	KFC2411/14	31,99	1
 Pack Ofiblock 2 bases eléctricas Schuko	KFC2421/14	42,67	1
 Pack Ofiblock 1 base Schuko y 1 carg.USB	KFC2422/14	138,64	1
 Pack Ofiblock 3 bases Schuko+2 RJ45 C.6U	KFC2446U/14	162,57	1

DESCRIPCIÓN	ARTÍCULO	PRECIO € Recomendado	PIEZAS CAJA
SOPORTE DE FIJACIÓN OFIBLOCK LINE K45			
 Juego de 2 garras para fijación de Ofiblock Line K45 (opcional)	KSF7	12,26	1
 Juego soporte Ofiblock K45 fij. bandeja	KSF8	5,60	1
 Juego soporte Ofiblock K45 fij. rejilla	KSF9	5,60	1





CAJAS DE SUPERFICIE Y EMPOTRAR K45			
 Cajetín K45 individual de superficie	R250/9	3,81	10
	R250/14	3,94	
 Cajetín K45 doble de superficie	R450/9	6,71	5
	R450/14	6,91	
 Cajetín universal de empotrar	31710-61	0,66	50
 Marco K45 individual y bastidor	KR245/9	3,56	20
	KR245/14	3,70	
 Marco K45 doble y bastidor	KR445/9	6,51	10
	KR445/14	6,68	



CAJAS DE SUELO ESTANCAS K45 IP66

CUBETAS Y ACCESORIO			
 Cubeta de falso suelo para caja de suelo estanca K45	KGE170TF/23	41,73	1
 Cubeta de empotrar para caja de suelo estanca K45	KGE170/23	28,93	1
 Accesorio de unión entre 2 cajas de suelo estancas K45 para pavimento	ACSE	5,55	10

PORTAMECANISMOS COMUNES PARA AMBAS CUBETAS			
	KSE1SEC/23/72	131,68	1
	KSE1SEC/23/71	131,68	
Unidad portamecanismos cierre de seguridad K45 para 1 mecanismo K45	KSE0SEC/23/72	126,70	1
	KSE0SEC/23/71	126,70	
Unidad portamecanismos cierre de seguridad K45 con 1 base eléctrica K45 y 1 conector RJ45 Cat.5e UTP	KSE15USEC/23/72	159,67	1
	KSE15USEC/23/71	159,67	
Unidad portamecanismos cierre de seguridad y alojamientos para una función K45, un conector RJ45 con clipaje Keystone y acabado latón	KSE01SEC/23/71	128,90	1
	KSE01SEC/23/72	128,90	
Unidad portamecanismos K45 con cierre de seguridad incluyendo una base de enchufe schuko, un conector RJ45 de categoría 6 UTP con clipaje Keystone y acabado latón	KSE16USEC/23/71	158,04	1
	KSE16USEC/23/72	158,04	

DESCRIPCIÓN	ARTÍCULO	PRECIO € Recomendado	PIEZAS CAJA
	KSE15U/23/72	133,43	1
	KSE15U/23/71	133,43	
Unidad portamecanismos cierre manual K45 para 1 mecanismo K45	KSE0/23/72	98,20	1
	KSE0/23/71	98,20	
Unidad portamecanismos cierre manual K45 con 1 base eléctrica K45	KSE1/23/72	103,95	1
	KSE1/23/71	103,95	
Unidad portamecanismos cierre manual con base eléctrica K45 y un conector RJ45 Cat.6 UTP	KSE16U/23/72	138,68	1
	KSE16U/23/71	138,68	
Unidad portamecanismos cierre manual K45 con 1 base eléctrica K45 y alojamiento para 1 conector RJ45 Keystone	KSE10U/23/71	125,52	1
	KSE10U/23/72	125,52	
Unidad portamecanismos K45 con cierre manual y alojamientos para una función K45, un conector RJ45 con clipaje Keystone y acabado latón	KSE01/23/71	117,69	1
	KSE01/23/72	117,69	
Unidad portamecanismos K45 con cierre manual incluyendo una base de enchufe británica y acabado latón	KSE4/23/71	107,69	1
	KSE4/23/72	107,69	



RECAMBIOS CAJAS DE SUELO ESTANCAS K45 IP66			
	RKS001/72	20,62	1
	RKS001/71	20,62	
 Junta de estanqueidad cuadrada para caja KSEX K45	RKS003	2,56	1
 Junta de estanqueidad circular para caja KSEX K45	RKS004	4,87	1
	RKS005/71	4,34	1
	RKS005/72	4,34	1



CAJAS DE SUELO SIMON K45 PROFUNDIDAD REDUCIDA			
	KF200/1	57,98	1
	KF300C/1	63,07	1
	KF400/1	68,30	1

TAPA EM.ACERO INOX CAJA SUELO			
	Tapa em. acero inox caja suelo reg.2 mecanismos	KF201/8	17,75 5
	Tapa em. acero inox caja suelo reg.4 mecanismos	KF401/8	21,80 5
	Tapa em. acero inox caja suelo reg.6 mecanismos	KF601/8	27,85 5
	Tapa em. acero inox caja suelo reg.8 mecanismos	KF801/8	36,40 5
	Tapa em. acero inox caja suelo reg.12 mecanismos	KF1201/8	43,95 5

CONECTIVIDAD

SIMON K45

DESCRIPCIÓN	ARTÍCULO	PRECIO € Recomendado	PIEZAS CAJA
TAPA EMBELLECEDORA			
 Tapa embellecedora Simon 500 Cima para caja de suelo cuadrada de 2 módulos profundidad reducida	52053202-035	7,66	1
 Tapa embellecedora Simon 500 Cima para caja de suelo circular de 3 módulos profundidad reducida	52053203-035	9,11	1
 Tapa embellecedora Simon 500 Cima para caja de suelo cuadrada de 4 módulos profundidad reducida	52053204-035	9,98	1

DESCRIPCIÓN	ARTÍCULO	PRECIO € Recomendado	PIEZAS CAJA
CUBETAS PARA CAJAS DE SUELO DE PROFUNDIDAD REDUCIDA EN PAVIMENTO			
 Cubeta de pavimento Simon 500 Cima para caja de suelo cuadrada de 2 módulos profundidad reducida	G201	26,83	1
 Cubeta de pavimento Simon 500 Cima para caja de suelo circular de 3 módulos profundidad reducida	G301C	28,10	1
 Cubeta de pavimento Simon 500 Cima para caja de suelo cuadrada de 4 módulos profundidad reducida	G401	35,20	1

MINICOLUMNAS DE SUELO K45

MINICOLUMNAS DE ALUMINIO K45 1 CARA

 Minicolumna K45 70x60mm altura 270mm 1 cara 5 mecanismos útiles K45	ALK115/8	97,88	1
Minicolumna K45 70x60mm altura 315mm 1 cara 6 mecanismos útiles K45	ALK116/8	100,04	1
Minicolumna K45 70x60mm altura 360mm 1 cara 7 mecanismos útiles K45	ALK117/8	101,58	1

MINICOLUMNAS DE ALUMINIO K45 2 CARAS OVALADA

 Minicolumna K45 110x80mm altura 210mm 2 caras 4 mecanismos útiles K45 por cara	ALK724/8	132,21	1
Minicolumna K45 110x80mm altura 260mm 2 caras 5 mecanismos útiles K45 por cara	ALK725/8	143,45	1
Minicolumna K45 110x80mm altura 310mm 2 caras 6 mecanismos útiles K45 por cara	ALK726/8	154,74	1

MINICOLUMNAS DE ALUMINIO K45 2 CARAS CUADRADA



 Minicolumna K45 80x80mm altura 225mm 2 caras 4 mecanismos útiles K45 por cara	ALK224/8	106,37	1
Minicolumna K45 80x80mm altura 285mm 2 caras 5 mecanismos útiles K45 por cara	ALK225/8	120,54	1
Minicolumna K45 80x80mm altura 345mm 2 caras 7 mecanismos útiles K45 por cara	ALK227/8	127,60	1

Diseñadas para bases eléctricas de embornado a tornillo en 1 cara y de VDM en la cara opuesta.

MINICOLUMNAS DE ALUMINIO K45 4 CARAS

 Minicolumna K45 125x130mm altura 210mm 4 caras 4 mecanismos útiles K45 por cara	ALK544/8	134,16	1
Minicolumna K45 125x130mm altura 260mm 4 caras 5 mecanismos útiles K45 por cara	ALK545/8	146,79	1
Minicolumna K45 125x130mm altura 310mm 4 caras 6 mecanismos útiles K45 por cara	ALK546/8	158,89	1

No admite bases eléctricas de embornado rápido en 2 de las 4 caras. Sin limitaciones para el resto de mecanismos.

DESCRIPCIÓN	ARTÍCULO	PRECIO € Recomendado	PIEZAS CAJA
ACCESORIOS MINICOLUMNAS K45			
 Posicionador 90° para placas K45 en perfiles verticales K45	K66	2,05	20
 Zócalo metálico K45 con 4 pretroqueles para canal DCS de 85x18mm	KTA804/8	37,77	1
 Tapa zócalo K45 auxiliar para adaptar minicolumna K45	ALKA02/8	13,15	1

RECAMBIOS MINICOLUMNAS K45

 Pie fijo invisible minicolumna 1 cara ALK11X/8	RALK005/8	66,00	1
 Pie fijo invisible minicolumna 2 caras ovalada ALK72X/8	RALK006/8	66,00	1
 Pie fijo invisible minicolumna 2 caras cuadrada ALK22X/8	RALK007/8	47,57	1
 Pie fijo invisible minicolumna 4 caras ALK54X/8	RALK008/8	47,57	1
 Tapa final minicolumna 1 cara ALK11X/8	RALK009/8	7,83	1
 Tapa final minicolumna 2 caras ovalada ALK72X/8	RALK010/8	11,85	1
 Tapa final invisible minicolumna 2 caras cuadrada ALK22X/8	RALK011/8	22,56	1
 Tapa final minicolumna 4 caras ALK54X/8	RALK012/8	18,14	1

COLUMNAS K45

COLUMNA K45 1 CARA

 Columna K45 70x60mm altura 3m 1 cara	ALK1100/8	259,66	1
--	-----------	--------	---

COLUMNA K45 2 CARAS OVALADA

 Columna K45 110x80mm altura 3m 2 caras	ALK7200/8	497,84	1
--	-----------	--------	---

DESCRIPCIÓN

ARTÍCULO PRECIO € PIEZAS CAJA
 Recomendado

COLUMNA K45 2 CARAS CUADRADA

	Columna K45 80x80mm altura 3m 2 caras	ALK2200/8	419,02	1
Diseñadas para bases eléctricas de embornado a tornillo en 1 cara y de VDM en la cara opuesta.				

COLUMNA K45 4 CARAS

	Columna K45 125x130mm altura 3m 4 caras	ALK5400/8	566,02	1
No admite bases eléctricas de embornado rápido en 2 de las 4 caras. Sin limitaciones para el resto de mecanismos.				

PROLONGACIÓN COLUMNAS K45

	Prolongación columna K45 2 caras ovalada de 0.5m aluminio	ALK72P05/8	175,32	1
	Prolongación columna K45 2 caras ovalada de 1m aluminio	ALK72P10/8	224,21	1
	Prolongación columna K45 2 caras ovalada de 1.5m aluminio	ALK72P15/8	289,77	1
	Prolongación columna K45 2 caras cuadrada de 0.5m aluminio	ALK22P05/8	81,54	1
	Prolongación columna K45 2 caras cuadrada de 1m aluminio	ALK22P10/8	122,05	1
	Prolongación columna K45 2 caras cuadrada de 1.5m aluminio	ALK22P15/8	143,70	1
	Prolongación columna K45 4 caras de 0.5m aluminio	ALK54P05/8	142,29	1
	Prolongación columna K45 4 caras de 1m aluminio	ALK54P10/8	232,84	1
	Prolongación columna K45 4 caras de 1.5m aluminio	ALK54P15/8	323,72	1

ACCESORIOS COLUMNAS K45

	Posicionador 90° para placas K45 en perfiles verticales K45	K66	2,05	20
--	---	-----	------	----

RECAMBIOS COLUMNAS K45

	Anillo embellecedor para falso techo columna 1 cara ALK1100/8	RALK001/8	31,22	1
	Anillo embellecedor para falso techo columna 2 caras cuadrada ALK2200/8	RALK002/8	37,45	1
	Anillo embellecedor para falso techo columna 2 caras ovalada ALK7200/8	RALK003/8	38,97	1
	Anillo embellecedor para falso techo columna 4 caras ALK5400/8	RALK004/8	38,97	1
	Tapa frontal 3m para columnas K45 ALK11X/8, ALK22X/8 y ALK54X/8	RALK013/8	39,75	1
	Tapa frontal 3m para columnas K45 ALK72X/8	RALK014/8	39,75	1

DESCRIPCIÓN

ARTÍCULO PRECIO € PIEZAS CAJA
 Recomendado

ENVOLVENTES METÁLICOS SIMON K45

CAJAS DE SUPERFICIE SIMON K45

	Caja metálica de superficie Simon K45 de 3 módulos	KM301/8	86,07	1
	Caja metálica de superficie Simon K45 de 4 módulos	KM401/8	104,28	1
	Caja metálica de superficie Simon K45 de 6 módulos	KM601/8	130,17	1



CAJAS DE EMPOTRAR SIMON K45

	Caja metálica de empotrar Simon K45 de 3 módulos	KTC300/8	95,80	1
	Caja metálica de empotrar Simon K45 de 4 módulos	KTC400/8	114,52	1
	Caja metálica de empotrar Simon K45 de 6 módulos	KTC600/8	136,95	1

TORRETAS 1 CARA SIMON K45



	Torreta metálica Simon K45 1 cara de 4 módulos	KT0800/8	140,89	1
	Torreta metálica Simon K45 1 cara de 5 módulos	KT0100/8	160,26	1

ACCESORIOS



	Tapa protectora con bombín para cajas de superficie y empotrar metálicas de 3 módulos	KMA301/8	74,22	1
	Tapa protectora con bombín para cajas de superficie y empotrar metálicas de 4 módulos	KMA401/8	81,98	1
	Tapa protectora con bombín para torreta metálica de 4 módulos	KTA802/8	81,98	1

INTERRUPTORES Y MECANISMOS DE CONMUTACIÓN K45

CONMUTADOR (INTERRUPTOR) K45 UNIPOLAR 16A

	Conmutador (interruptor) K45 unipolar 16A	K301	6,93	10
	Tecla K45 1 mecanismo	K110/8	6,83	5
		K110/9	2,03	10
		K110/14	2,06	10
	Tecla K45 1/2 mecanismo	K109/8	5,96	5
		K109/9	1,77	10
		K109/14	1,80	10

CONMUTADOR (INTERRUPTOR) K45 UNIPOLAR 16A CON PILOTO DE ESTADO



	Conmutador (interruptor) K45 unipolar 16A con piloto de estado	K302	11,41	10
	Tecla K45 1 mecanismo con visor rojo	K112/8	8,99	5
		K112/9	2,67	10
		K112/14	2,71	10

CONECTIVIDAD



SIMON K45

DESCRIPCIÓN	ARTÍCULO	PRECIO € <small>Recomendado</small>	PIEZAS CAJA
 Tecla K45 1/2 mecanismo con visor rojo	K115/8	7,92	5
	K115/9	2,31	10
	K115/14	2,38	10

PULSADOR K45 UNIPOLAR 16 A

 Pulsador unipolar K45 16A	K303	7,65	10
 Tecla K45 para 1 mecanismo	K110/8	6,83	5
	K110/9	2,03	10
	K110/14	2,06	10
 Tecla K45 para 1/2 mecanismo	K109/8	5,96	5
	K109/9	1,77	10
	K109/14	1,80	10

PULSADOR K45 UNIPOLAR 16 A CON PILOTO LUMINOSO

 Pulsador unipolar K45 16A con piloto luminoso	K304	12,54	10
 Tecla K45 1 mecanismo con visor transparente	K114/8	8,99	5
	K114/9	2,67	10
	K114/14	2,71	10
 Tecla K45 1/2 mecanismo con visor transparente	K113/8	7,92	5
	K113/9	2,31	10
	K113/14	2,38	10

RECAMBIO

 Posicionador 90° para mecanismos de conmutación K45 en columnas K45 o perfiles verticales	K366	2,05	10
--	------	------	----



*Se suministra con el mecanismo.











MECANISMOS DE CONMUTACIÓN BIPOLARES 16 A

 Placa K45 con interruptor luminoso bipolar de 16A	KL04/9	10,29	10
	KL04/14	10,51	

BASES DE ENCHUFE





BASES DE ENCHUFE INTERNACIONALES



 Base enchufe británica 13A sin int.	K04/9	10,67	10
	K04/14	10,88	
 Base enchufe sud africana 15A 2 elementos	K07/9	10,67	10
	K07/14	10,88	
 Base enchufe suiza 10A 2 elementos	K08/9	14,35	10
	K08/14	14,64	
 Base enchufe danesa 13A 2 elementos	K15/9	12,24	10
	K15/14	12,48	

DESCRIPCIÓN	ARTÍCULO	PRECIO € <small>Recomendado</small>	PIEZAS CAJA
 Base enchufe israelí 16A 2 elementos	K03/9	12,50	10
	K03/14	12,75	
 Base enchufe india 15A 2 elementos	K09/9	13,00	10
	K09/14	13,26	
 Base enchufe multi 5/6/10/13A 2 elementos	K23/9	13,50	10
	K23/14	13,77	
 Base bipasso italiana 10/16A 1 elemento	K06/9	8,95	10
	K06/6	8,95	
	K06/14	9,13	
 Base de enchufe P40 16A 250V 2 elementos	K05/9	10,99	10
	K05/6	10,99	
	K05/14	11,21	
 Base enchufe doble Schuko emb.rápido	K12/9	14,90	10
	K12/14	15,20	
	K12/6	15,50	
 Base enchufe triple Schuko emb.rápido	K13/9	22,80	10
	K13/14	23,26	
	K13/6	23,72	
 Base enchufe quad. Schuko emb.rápido	K14/9	30,70	10
	K14/14	31,31	
	K14/6	31,31	
 Base enchufe doble Francesa emb.rápido	K32/9	14,90	10
	K32/14	15,20	
	K32/6	15,50	
 Base enchufe triple Francesa emb.rápido	K33/9	22,80	10
	K33/14	23,26	
	K33/6	23,72	
 Base enchufe quad. Francesa e.rápido bl	K34/9	30,70	10
	K34/14	31,31	
	K34/6	31,31	

BASES ELÉCTRICAS K45



BASES ELÉCTRICAS K45 EMBORNAMIENTO RÁPIDO Y MULTIBASES

 Base eléctrica K45 embornamiento rápido con obturador de protección	K11/8	11,73	10	
	K11/6	8,10		
	K11/7	8,27		
	K11/9	8,10		
	K11/14	8,23		
	K11/27	8,27		
 Base eléctrica K45 embornamiento rápido con obturador de seguridad	KS11/8	17,30	10	
	KS11/6	12,17		
	KS11/9	12,17		
	KS11/14	12,42		
	 Base francesa K45 embornamiento rápido con obturador de protección	K22/8	11,73	10
		K22/6	8,10	
K22/7		8,27		
K22/9		8,10		
K22/14		8,23		
K22/27		8,27		
 Base francesa K45 embornamiento rápido con obturador de seguridad	KS22/6	12,17	10	
	KS22/9	12,17		
	KS22/14	12,42		

DESCRIPCIÓN	ARTÍCULO	PRECIO € Recomendado	PIEZAS CAJA
 Bloque de conexión para bases de embornamiento rápido K45	AC11	1,07	20
 Pin para desbloqueo del obturador de seguridad	AC33/6	1,10	20

DESCRIPCIÓN	ARTÍCULO	PRECIO € Recomendado	PIEZAS CAJA
 Placa K45 3 mecanismos para magnetotérmico o diferencial, formato DIN	KF03/8	15,40	10
	KF03/9	13,58	
	KF03/14	13,83	

BASES ELÉCTRICAS K45 EMBORNAMIENTO A TORNILLO

	K01/8	8,12	10
	K01/6	5,14	
	K01/7	5,26	
	K01/9	5,14	
Base eléctrica K45 embornamiento a tornillo con obturador de prot y piloto indicador	K01/14	5,24	
	KL01/6	8,45	10
	KL01/7	8,66	
	KL01/8	12,26	
Base eléctrica K45 embornamiento a tornillo con obturador de seg y piloto indicador	KL01/9	8,45	
	KL01/14	8,59	
	KLS01/6	11,05	10
	KLS01/7	11,32	
Base francesa K45 embornamiento a tornillo con obturador de protección	KLS01/8	16,01	
	KLS01/9	11,05	
	KLS01/14	11,27	
	K02/8	8,12	10
Base francesa K45 embornamiento a tornillo con obturador de protección	K02/6	5,14	
	K02/9	5,14	
	K02/14	5,24	
	KL02/6	8,45	10
Base francesa K45 embornamiento a tornillo con obturador de prot y piloto indicador	KL02/9	8,45	
	KL02/14	8,59	
	KLS02/6	11,05	10
Base francesa K45 embornamiento a tornillo con obturador de seg y piloto indicador	KLS02/9	11,05	
	KLS02/14	11,27	
	 Pin para desbloqueo del obturador de seguridad	AC33/6	1,10

PLACAS K45 V&D CON CONECTORES SIMON RJ45

CAT.6 UTP

	K8096U/8	18,36	10
	K8096U/9	16,18	
	K8096U/14	16,21	
Placa K45 V&D inclinada con guardapolvo con 2 conectores Cat.6 UTP	KB8096U/8	34,86	10
	KB8096U/9	30,67	
	KB8096U/14	30,72	
Placa K45 1/2 mecanismo V&D plana con guardapolvo con 1 conector Cat.6 UTP	KA96U/8	18,37	10
	KA96U/9	15,69	
	KA96U/14	15,73	
Placa K45 V&D plana con guardapolvo con 1 conector Cat.6 UTP	K96U/8	18,18	10
	K96U/9	16,07	
	K96U/14	16,15	
Placa K45 V&D plana con guardapolvo con 2 conectores Cat.6 UTP	KB96U/8	34,20	10
	KB96U/9	30,52	
	KB96U/14	29,69	
Placa K45 V&D plana sin guardapolvo con 1 conector Cat.6 UTP	K096U/9	15,58	10
Placa K45 V&D plana sin guardapolvo con 2 conectores Cat.6 UTP	KB096U/9	29,27	10

CAT.6 FTP

	K8096F/8	21,60	10
	K8096F/9	19,07	
	K8096F/14	19,10	
Placa K45 1/2 mecanismo V&D plana con guardapolvo con 1 conector Cat.6 FTP	KA96F/8	21,80	10
	KA96F/9	18,65	
	KA96F/14	18,69	
Placa K45 V&D plana con guardapolvo con 1 conector Cat.6 FTP	K96F/8	21,58	10
	K96F/9	19,13	
	K96F/14	19,17	
Placa K45 V&D plana con guardapolvo con 2 conectores Cat.6 FTP	KB96F/8	42,43	10
	KB96F/9	36,47	
	KB96F/14	37,58	
Placa K45 V&D plana sin guardapolvo con 1 conector Cat.6 FTP	K096F/9	18,20	10















ELEMENTOS DE PROTECCIÓN K45















PLACAS K45 CON ELEMENTOS DE PROTECCIÓN INCORPORADOS

	KF04A/8	35,13	5
	KF04A/9	25,05	
	KF04A/14	25,18	
Placa K45 3 mecanismos con magnetotérmico 10A, formato DIN	KF04B/8	33,67	5
	KF04B/9	23,61	
	KF04B/14	23,73	
Placa K45 3 mecanismos con diferencial 30 MA, formato DIN	KF04C/8	104,77	5
	KF04C/9	106,19	
	KF04C/14	106,31	
Placa K45 con magnetotérmico 10A	K106A/8	79,52	1
	K106A/9	60,41	
	K106A/14	61,16	
Placa K45 con magnetotérmico-diferencial de 10A e In de 10mA	K107A/8	186,19	1
	K107A/9	141,51	
	K107A/14	143,01	

CONECTIVIDAD

SIMON K45

DESCRIPCIÓN	ARTÍCULO	PRECIO € <small>Recomendado</small>	PIEZAS CAJA
 Placa K45 V&D plana sin guardapolvo con 2 conectores Cat.6 FTP	KB096F/9	34,35	10
CAT.5E UTP			
 Placa K45 V&D inclinada con guardapolvo con 1 conector Cat.5e UTP	K8095U/8	13,46	10
	K8095U/9	11,79	
	K8095U/14	11,83	
 Placa K45 V&D inclinada con guardapolvo con 2 conectores Cat.5e UTP	KB8095U/8	25,01	10
	KB8095U/9	21,87	
	KB8095U/14	21,92	
 Placa K45 1/2 mecanismo V&D plana con guardapolvo con 1 conector Cat.5 UTP	KA95U/8	13,35	10
	KA95U/9	11,38	
	KA95U/14	11,41	
 Placa K45 V&D plana con guardapolvo con 1 conector Cat.5e UTP	K95U/8	13,35	10
	K95U/9	11,76	
	K95U/14	11,81	
 Placa K45 V&D plana con guardapolvo con 2 conectores Cat.5e UTP	KB95U/8	24,45	10
	KB95U/9	21,83	
	KB95U/14	21,26	
 Placa K45 V&D plana sin guardapolvo con 1 conector Cat.5e UTP	K095U/9	10,96	10
 Placa K45 V&D plana sin guardapolvo con 2 conectores Cat.5e UTP	KB095U/9	19,51	10
CAT.5E FTP			
 Placa K45 V&D inclinada con guardapolvo con 1 conector Cat.5e FTP	K8095F/8	17,14	10
	K8095F/9	15,41	
	K8095F/14	15,44	
 Placa K45 1/2 mecanismo V&D plana con guardapolvo con 1 conector Cat.5 FTP	KA95F/8	17,63	10
	KA95F/9	15,05	
	KA95F/14	15,08	
 Placa K45 V&D plana con guardapolvo con 1 conector Cat.5e FTP	K95F/8	17,51	10
	K95F/9	15,48	10
	K95F/14	15,52	10
 Placa K45 V&D plana con guardapolvo con 2 conectores Cat.5e FTP	KB95F/8	32,90	10
	KB95F/9	29,35	
	KB95F/14	30,27	
 Placa K45 V&D plana sin guardapolvo con 1 conector Cat.5e FTP	K095F/9	14,73	10
 Placa K45 V&D plana sin guardapolvo con 2 conectores Cat.5e FTP	KB095F/9	27,64	10

DESCRIPCIÓN	ARTÍCULO	PRECIO € <small>Recomendado</small>	PIEZAS CAJA
ACCESORIO			
 Posicionador 90° para Placas K45 en perfiles verticales K45	K66	2,05	20
PLACAS K45 VOZ Y DATOS PARA CONECTORES RJ45			
PLACAS K45 V&D INCLINADAS CON GUARDAPOLVO PARA CONECTORES SIMON Y OTRAS MARCAS			
 Placa K45 V&D inclinada con guardapolvo para 1 módulo MD	K80/8	8,62	
	K80/9	4,18	20
	K80/14	4,25	
 Placa K45 V&D inclinada con guardapolvo para 2 módulos MD	KB80/8	14,44	
	KB80/9	6,19	20
	KB80/14	6,29	
PLACAS K45 V&D INCLINADAS SIN GUARDAPOLVO PARA CONECTORES SIMON Y OTRAS MARCAS			
 Placa K45 V&D inclinada sin guardapolvo para 1 módulo MD	K080/9	3,11	20
	K080/14	3,16	
 Placa K45 V&D inclinada sin guardapolvo para 2 módulos MD	KB080/9	3,44	20
	KB080/14	3,49	
MÓDULOS MD PARA PLACAS K45 INCLINADAS			
 Módulo MD para 1 conector 3M Volition OCK®	MD45	0,77	50
 Módulo MD para 1 conector (R&M)®	MD54	0,77	50
 Módulo MD para 1 conector Systimax® (Avaya®)	MD63	0,77	50
 Módulo MD para 1 conector Amp®, Krone® o BeldenCDT®	MD64	0,77	50
 Módulo MD para 1 conector Amp®, Brand Rex® o Simon Connect®	MD67	0,77	50
 Módulo MD para 1 conector BeldenCDT (Nordx)®	MD68	0,77	50
 Módulo MD para 1 conector Panduit®	MD69	0,77	50
 Módulo MD para 1 conector Corning® Siemens®	MD79	0,77	50
 Módulo MD para 1 conector Nexans®	MD85	0,77	50





















DESCRIPCIÓN

ARTÍCULO PRECIO € PIEZAS
 Recomendado CAJA

ACCESORIO

	Posicionador 90° para placas K45 en perfiles verticales K45	K66	2,05	20
---	---	------------	------	----

PLACAS K45 V&D PLANAS CON GUARDAPOLVO PARA CONECTORES SIMON Y OTRAS MARCAS















	Placa K45 1/2 mec. V&D plana con guardapolvo para 1 conector Amp®, Brand Rex®, Systimax® (Avaya®), Krone® o BeldenCDT® (sustituye las ref. KA63/... KA64/... KA67/...)	KA76/8	6,98	20
		KA76/9	4,18	
		KA76/14	4,23	
	Placa K45 1/2 mec V&D plana con guardapolvo para 1 conector ITT Cannon®	KA65/9	4,18	20
		KA65/14	4,23	
	Placa K45 1/2 mec V&D plana con guardapolvo para 1 conector BeldenCDT®	KA68/9	4,18	20
		KA68/14	4,23	
	Placa K45 1/2 mec V&D plana con guardapolvo para 1 conector Panduit®	KA69/9	4,18	20
		KA69/14	4,23	
	Placa K45 1/2 mec V&D plana con guardapolvo para 1 conector Infra+®	KA75/9	4,18	20
		KA75/14	4,23	
	Placa K45 1/2 mec V&D plana con guardapolvo para 1 conector Nexans®	KA85/9	4,18	20
		KA85/14	4,23	
	Placa K45 V&D plana con guardapolvo para 1 conector Amp®, Brand Rex®, Systimax® (Avaya®), Krone® o BeldenCDT® (sustituye las ref. K63/... K64/.../K67/...)	K76/8	7,85	20
		K76/9	4,73	
		K76/14	4,82	
	Placa K45 V&D plana con guardapolvo para 1 conector ITT®	K65/9	4,73	20
		K65/14	4,82	
	Placa K45 V&D plana con guardapolvo para 1 conector BeldenCDT® (Nordx®)	K68/9	4,73	20
		K68/14	4,82	
	Placa K45 V&D plana con guardapolvo para 1 conector Panduit®	K69/9	4,73	20
		K69/14	4,82	
	Placa K45 V&D plana con guardapolvo para 1 conector Infra+®	K75/9	4,73	20
		K75/14	4,82	
	Placa K45 V&D plana con guardapolvo para 1 conector Krone®	K82/9	4,73	20
		K82/14	4,82	
	Placa K45 V&D plana con guardapolvo para 1 conector Nexans®	K85/9	4,73	20
		K85/14	4,82	
	Placa K45 V&D plana con guardapolvo para 1 conector IBM®	K87/9	4,73	20
		K87/14	4,82	
	Placa K45 V&D plana con guardapolvo para 2 conectores Amp®, Brand Rex®, Systimax® (Avaya®), Krone® o BeldenCDT® (sustituye las ref. KB63/... KB64/... KB67/...)	KB76/8	9,09	20
		KB76/9	7,41	
		KB76/14	7,53	
	Placa K45 V&D plana con guardapolvo para 2 conectores ITT Cannon®	KB65/9	7,41	20
		KB65/14	7,53	
	Placa K45 V&D plana con guardapolvo para 2 conectores BeldenCDT® (Nordx®)	KB68/9	7,41	20
		KB68/14	7,53	
	Placa K45 V&D plana con guardapolvo para 2 conectores Panduit®	KB69/9	7,41	20
		KB69/14	7,53	
	Placa K45 V&D plana con guardapolvo para 2 conectores Infra+®	KB75/9	7,41	20
		KB75/14	7,53	
	Placa K45 V&D plana con guardapolvo para 2 conectores Nexans®	KB85/9	7,41	20
		KB85/14	7,53	
	Placa K45 V&D plana con guardapolvo para 2 conectores IBM®	KB87/9	7,41	20
		KB87/14	7,53	

PLACAS K45 V&D PLANAS SIN GUARDAPOLVO PARA CONECTORES SIMON Y OTRAS MARCAS

	Placa K45 1/2 mec V&D plana sin guardapolvo para 1 conector 3M OCK®	KA045/9	3,26	20
		KA045/14	3,35	

DESCRIPCIÓN

ARTÍCULO PRECIO € PIEZAS
 Recomendado CAJA



	Placa K45 1/2 mecanismo V&D plana sin guardapolvo para 1 conector Ortronics®	K281/9	2,42	20
		K281/14	2,47	
	Placa K45 V&D plana sin guardapolvo para 1 conector 3M OCK®	K045/9	3,72	20
		K045/14	3,83	
	Placa K45 V&D plana sin guardapolvo para 1 conector R&M®	K054/9	3,72	20
		K054/14	3,83	
	Placa K45 V&D plana sin guardapolvo para 1 conector SIMON®, AMP®, Brand Rex®, Systimax® (Avaya®), Krone® o BeldenCDT® (sustituye las ref. K063/... K064/... K067/...)	K076/9	3,72	20
		K076/14	3,83	
	Placa K45 V&D plana sin guardapolvo para 1 conector Panduit®	K069/9	3,72	20
		K069/14	3,83	
	Placa K45 V&D plana sin guardapolvo para 1 conector Infra+®	K075/9	3,72	20
		K075/14	3,83	
	Placa K45 V&D plana sin guardapolvo para 1 conector Nexans®	K085/9	3,72	20
		K085/14	3,83	
	Placa K45 V&D plana sin guardapolvo para 1 conector IBM®	K087/9	3,72	20
		K087/14	3,83	
	Placa K45 V&D plana sin guardapolvo para 2 conectores 3M OCK®	KB045/9	4,75	20
		KB045/14	4,88	
	Placa K45 V&D plana sin guardapolvo para 2 conectores Amp®, Brand Rex®, Systimax® (Avaya®), Krone® o BeldenCDT® (sustituye las ref. KB063/... KB064/... KB067/...)	KB076/9	4,75	20
		KB076/14	4,88	
	Placa K45 V&D plana sin guardapolvo para 2 conectores Panduit®	KB069/9	4,75	20
		KB069/14	4,88	
	Placa K45 V&D plana sin guardapolvo para 2 conectores Siemon®	KB72/9	4,75	20
	Placa K45 V&D plana sin guardapolvo para 2 conectores Infra+®	KB075/9	4,75	20
		KB075/14	4,88	
	Placa K45 V&D plana sin guardapolvo para 2 conectores Nexans®	KB085/9	4,75	20
		KB085/14	4,88	

ACCESORIO

	Posicionador 90° para Placas K45 en perfiles verticales K45	K66	2,05	20
---	---	------------	------	----

CONECTORES MULTIMEDIA K45

CONECTORES TV Y SAT CON PLACAS K45

	Placa K45 con toma de TV macho + SAT hembra unica CEI conexión mediante tornillo	K130A/8	29,73	10
		K130A/9	25,23	
		K130A/14	25,70	
	Placa K45 con toma de TV simple CEI macho, conexión mediante tornillo	K120A/8	17,07	10
		K120A/9	13,25	
		K120A/14	13,53	
	Placa K45 1/2 mecanismo con 1 toma de TV simple CEI hembra, conexión mediante soldadura	K102B/8	11,08	10
		K102B/9	8,67	
		K102B/14	8,86	
	Placa K45 1/2 mecanismo con 1 toma satellite simple hembra, conexión mediante soldadura	K102C/8	11,58	10
		K102C/9	9,00	
		K102C/14	9,16	

SIMON K45















CONECTIVIDAD

SIMON K45



DESCRIPCIÓN

ARTÍCULO PRECIO € PIEZAS
 Recomendado CAJA

CONECTORES PARA CARGA, DATOS AUDIO Y VIDEO CON PLACAS K45

	Cargador USB (1,5A) ½ elemento K45	K126C/8	44,08	1
		K126C/9	37,68	
		K126C/14	38,81	
	Cargador USB (2,1A) ½ elemento K45	K126D/8	51,38	1
		K126D/9	43,90	
		K126D/14	45,25	
	Cargador USB (2,1A) 1 elemento K45	K126E/8	51,38	1
		K126E/9	43,90	
		K126E/14	45,25	
	Cargador USB tipo "A+C" 3,1A con Quickcharge 2 elementos K45	K126F/8	53,38	1
		K126F/9	46,42	
		K126F/14	47,58	
	Cargador USB (4,2A) 1 elemento K45 tipo "A+C"	K126G/8	53,38	1
		K126G/9	46,42	
		K126G/14	47,58	
	Cargador USB Tipo A+C 65W 2 elementos K45	K126H/9	85,47	1
		K126H/14	87,22	
		K126H/8	92,35	
	Cargador USB tipo C 1 elemento	K126I/9	43,04	1
		K126I/14	44,36	
		K126I/8	50,37	
	Placa K45 ½ mecanismo con 1 conector USB tipo B conexión tipo B hembra - tipo A hembra	K131B/9	30,50	1
	Placa K45 ½ mecanismo con 1 conector USB tipo "A" hembra conexión a tornillo	K128B/8	26,84	1
		K128B/14	24,14	
			24,38	
	Placa K45 ½ mecanismo con 1 conector HDMI. conexión hembra-hembra	K129B/8	32,94	1
		K129B/9	30,50	
		K129B/14	30,78	
	Placa K45 1 mecanismo con 1 conector VGA HD15 hembra, conexión a tornillo	K100B/8	31,96	1
		K100B/9	29,03	
		K100B/14	29,33	
	Placa K45 ½ mecanismo con 2 conectores RCA audio, conexión a tornillo	K101B/8	26,04	1
		K101B/9	23,42	
		K101B/14	23,66	
	Placa K45 ½ mecanismo con 3 conectores RCA audio, conexión a tornillo	K105B/8	26,84	1
		K105B/9	24,14	
		K105B/14	24,38	
	Placa K45 ½ mecanismo con 1 conector mini jack stereo 3,5mm conexión a tornillo	K123B/8	26,84	1
		K123B/9	24,14	
		K123B/14	24,38	
	Placa K45 ½ mecanismo con 1 conector s-video hembra. conexión a tornillo	K103B/8	26,84	1
		K103B/9	24,14	
		K103B/14	24,38	







CONECTORES PARA VIDEO Y DATOS CON PLACAS K45. CONEXIÓN SOLDADURA

	Placa K45 1/2 mecanismo con 1 conector VGA HD15 hembra conexión mediante soldadura	K100A/8	10,79	10
		K100A/9	8,80	
		K100A/14	8,97	
	Placa K45 1/2 mecanismo con 1 conector BNC 75 Ω, conexión mediante soldadura	K102D/8	14,35	10
		K102D/9	11,78	
		K102D/14	12,02	
	Placa K45 2 mecanismos con 1 conector DB25 (puerto paralelo), conexión mediante soldadura	K104A/8	11,21	5
		K104A/9	9,50	
		K104A/14	9,71	

DESCRIPCIÓN

ARTÍCULO PRECIO € PIEZAS
 Recomendado CAJA

PLACAS K45 PARA CONECTORES AUDIO-VÍDEO



	Placa K45 1/2 mecanismo para 1 conector SUB D9 (VGA o puerto serie)	K100/9	1,86	20
		K100/14	1,88	
	Placa K45 1/2 mecanismo para 2 conectores RCA	K101/9	1,86	20
		K101/14	1,88	
	Placa K45 1/2 mecanismo para 1 conector BNC	K102/9	1,86	20
		K102/14	1,88	
	Placa K45 1/2 mecanismo para 1 conector s-video	K103/9	1,86	20
		K103/14	1,88	
	Placa K45 para 1 conector XLR macho o hembra	K122/8	7,54	20
		K122/9	3,25	
		K122/14	3,28	
	Placa K45 2 mecanismos para 1 conector SUB D25 (puerto paralelo)	K104/9	5,88	10
		K104/14	5,94	

PLACAS K45 SISTEMA DE CONEXIÓN RÁPIDA



PLACAS K45 CON CONECTOR DE CONEXIÓN RÁPIDA IEC320

	Placa K45 con 1 conector rápido macho IEC320	K305A/14	4,38	10
	Placa K45 con 1 conector rápido hembra IEC320	K306A/9	5,00	10
		K306A/14	5,07	

PLACAS K45 CON CONECTOR DE CONEXIÓN RÁPIDA





	Placa K45 2 conexión rápida macho 3 polos grafito-rojo grafito	KB18A/14	10,70	5
	Placa K45 1/2 mecanismo con 1 conector conexión rápida macho 3 polos	K121A/9	4,90	10
		K121A/14	4,95	
	Placa K45 1/2 mecanismo con 1 conector conexión rápida hembra 3 polos	K121B/9	5,33	10
		K121B/14	5,38	

PLACAS K45 PARA CONECTORES DE CONEXIÓN RÁPIDA

	Placa K45 1/2 mecanismo para 1 conector conexión rápida macho o hembra 3 polos	K121/9	1,84	20
		K121/14	1,87	
	Placa K45 para 1 conector conexión rápida macho o hembra 3 polos	K18/9	3,24	20
		K18/14	3,30	
	Placa K45 para 2 conectores conexión rápida macho o hembra 3 polos	KB18/9	3,24	20
		KB18/14	3,30	

DESCRIPCIÓN	ARTÍCULO	PRECIO € Recomendado	PIEZAS CAJA
 Placa K45 2 mecanismos para 1 conector conexión rápida macho o hembra 5 polos	K18W5/9	5,57	10
	K18W5/14	5,68	



PLACAS K45 V&D + RJ45

 Placa V&D + RJ45 cat.6 UTP h-h 2 elementos	K96UF/9	18,11	1
	K96UF/14	18,20	
 Placa V&D + RJ45 cat.6 FTP h-h 2 elementos	K96FF/9	21,00	1
	K96FF/14	21,09	
 Placa V&D + RJ45 cat.6A UTP h-h 2 elementos	K96AUF/9	18,53	1
	K96AUF/14	18,62	
 Placa V&D + RJ45 cat.6A FTP h-h 2 elementos	K96AFF/9	21,17	1
	K96AFF/14	21,26	

PLACAS CON USB TIPO A 3.0

 Placa con USB Tipo A 3.0 h-h 1 elemento	K128C/9	28,30	1
	K128C/14	28,80	
 Placa con USB Tipo C 3.0 h-h 1 elemento	K128E/9	29,50	1
	K128E/14	29,90	
 Placa con USB Tipo A 3.0 lat. 2 elementos	K128D/9	40,80	1
	K128D/14	41,60	
 Placa con USB Tipo C 3.0 lat. 2 elementos	K128F/9	43,90	1
	K128F/14	44,70	

PLACA CON DISPLAYPORT 2.0

 Placa con Displayport 2.0 h-h 1 elementos	K132A/9	28,90	1
	K132A/14	29,45	
 Placa con Displayport 2.0 lat. 2 elementos	K132B/9	43,30	1
	K132B/14	44,20	

PLACA CON VGA+MINIJACK





 Placa con VGA+Minijack lat. 2 elementos	K100C/9	44,40	1
	K100C/14	45,30	

DESCRIPCIÓN	ARTÍCULO	PRECIO € Recomendado	PIEZAS CAJA
PLACA CON HDMI			
 Placa con HDMI 2.0 latiguillo 2 elementos	K129C/9	43,30	1
	K129C/14	44,20	

PLACA CON 3RCA LATIGUILLO

 Placa con 3RCA latiguillo 2 elementos	K105C/9	53,40	1
	K105C/14	54,45	



PLACAS K45 PARA SALIDA DE CABLES

 Placa K45 salida de cables con anillas para embroidar	K10/8	7,83	20
	K10/9	3,24	
	K10/14	3,33	
 Placa K45 para tubo o prensaestopa PG 16 (ø22mm) y pre-troquel PG 21	K19/9	3,24	20
	K19/14	3,33	
 Placa K45 salida de cables con retenedor (2 de ø13mm y 4 de ø6mm)	K20/9	3,24	20
	K20/14	3,33	
 Placa K45 para entrada de canal de 20x30 para Ofiblock plus	K21/9	3,24	20
	K21/14	3,33	

PLACAS K45 PARA SEÑALIZACIÓN Y BALIZADO

 Placa K45 con piloto indicador de tension	KL05/9	8,01	10
	KL05/14	8,16	

PLACAS K45 CIEGAS Y ACCESORIO ADAPTACIÓN MECANISMOS

 Placa K45 ciega medio mecanismo	K105/8	5,91	20
	K105/9	2,12	
	K105/14	2,18	
 Placa K45 ciega	K17/8	7,51	20
	K17/9	3,10	
	K17/14	3,18	



MINICANAL

MINICANAL DE PVC Y LIBRE DE HALÓGENOS (LSZH)

DESCRIPCIÓN	ARTÍCULO	PRECIO € Recomendado	PIEZAS CAJA
Minicanal de PVC 10x22mm de 1 compartimento	TM1022/9	1,46	96 m
Minicanal libre de halógenos (LSZH) 10x22mm de 1 compartimento	TM1022/19	4,06	96 m
Minicanal de PVC 20x30mm de 1 compartimento	TM12021/9	3,24	60 m
Minicanal de PVC 20x30mm de 2 compartimentos	TM12022/9	4,19	60 m
Minicanal libre de halógenos (LSZH) 20x30mm de 1 compartimento	TM12021/19	8,15	60 m
Minicanal libre de halógenos (LSZH) 20x30mm de 2 compartimentos	TM12022/19	9,44	60 m
Minicanal de PVC 20x50mm de 1 compartimento	TM12031/9	4,92	54 m
Minicanal de PVC 20x50mm de 2 compartimentos	TM12032/9	5,62	54 m
Minicanal libre de halógenos (LSZH) 20x50mm de 1 compartimento	TM12031/19	12,86	54 m
Minicanal libre de halógenos (LSZH) 20x50mm de 2 compartimentos	TM12032/19	14,93	54 m
Minicanal de PVC 40x60mm de 1 compartimento	TM12051/9	9,03	24 m
Minicanal de PVC 40x60mm de 2 compartimentos	TM12052/9	9,27	24 m
Minicanal libre de halógenos (LSZH) 40x60mm de 1 compartimento	TM12051/19	21,19	24 m
Minicanal libre de halógenos (LSZH) 40x60mm de 2 compartimentos	TM12052/19	24,61	24 m

ACCESORIOS MINICANAL DE PVP / LIBRE DE HALÓGENOS (LSZH)

DESCRIPCIÓN	ARTÍCULO	PRECIO € Recomendado	PIEZAS CAJA
Ángulo plano 10x22mm	TMA101201/9	1,12	24 ud.
Ángulo plano 20x30mm	TMA101202/9	2,40	12 ud.
Ángulo plano 20x50mm	TMA101203/9	2,98	12 ud.
Ángulo plano 40x60mm	TMA101205/9	6,94	6 ud.
Ángulo exterior 10x22mm	TMA102201/9	1,24	24 ud.
Ángulo exterior 20x30mm	TMA102202/9	2,73	12 ud.
Ángulo exterior 20x50mm	TMA102203/9	3,36	12 ud.
Ángulo exterior 40x60mm	TMA102205/9	6,99	6 ud.
Ángulo interior 10x22mm	TMA103201/9	1,18	24 ud.
Ángulo interior 20x30mm	TMA103202/9	2,68	12 ud.
Ángulo interior 20x50mm	TMA103203/9	3,30	12 ud.
Ángulo interior 40x60mm	TMA103205/9	6,99	6 ud.
Tapa final 10x22mm	TMA104201/9	1,19	24 ud.
Tapa final 20x30mm	TMA104202/9	2,66	12 ud.
Tapa final de 20x50mm	TMA104203/9	3,32	12 ud.
Tapa final de 40x60mm	TMA104205/9	3,44	6 ud.

DESCRIPCIÓN	ARTÍCULO	PRECIO € Recomendado	PIEZAS CAJA
Tapajuntas 10x22mm	TMA105201/9	1,09	24 ud.
Tapajuntas 20x30mm	TMA105202/9	2,46	12 ud.
Tapajuntas 20x50mm	TMA105203/9	2,86	12 ud.
Tapajuntas de 40x60mm	TMA105205/9	3,16	6 ud.
Derivación en "T" 10x22mm	TMA106201/9	1,46	24 ud.
Derivación en "T" 20x30mm	TMA106202/9	3,42	12 ud.
Derivación en "T" de 20x50mm	TMA106203/9	3,57	12 ud.
Derivación en "T" de 40x60mm	TMA106205/9	3,16	6 ud.
Retenedor de cables para canal 40x60mm	TMA107205/9	0,85	20 ud.

MINICANAL DE ALUMINIO CON TAPA DE 65 MM

DESCRIPCIÓN	ARTÍCULO	PRECIO € Recomendado	PIEZAS CAJA
Minicanal de aluminio 65x20mm de 2 compartimentos aluminio anodizado	TM21042/8	51,64	16 m
Ángulo exterior 65x20mm aluminio anodizado	TMA202104/8	28,91	1 ud.
Ángulo interior 65x20mm aluminio anodizado	TMA203104/8	27,47	1 ud.
Tapa final 65x20mm aluminio anodizado	TMA204404/8	6,77	5 ud.
Minicanal de aluminio 65x40mm de 1 compartimento aluminio anodizado	TM21061/8	57,76	16 m
Ángulo plano 65x40mm aluminio anodizado	TMA201106/8	29,97	1 ud.
Ángulo exterior 65x40mm acero inoxidable gris claro	TMA202406/24	20,16	1 ud.
Ángulo interior 65x40mm acero inoxidable gris claro	TMA203406/24	18,91	1 ud.
Tapa final 65x40mm aluminio anodizado	TMA204106/8	8,96	5 ud.

ACCESORIOS MINICANAL ALUMINIO CON TAPA DE 65 MM

DESCRIPCIÓN	ARTÍCULO	PRECIO € Recomendado	PIEZAS CAJA
Pasador unión de perfiles	TKA903	2,14	10 ud.
Cable con conector faston para unión de tierra 120mm	TKA904	2,14	10 ud.

DESCRIPCIÓN ARTÍCULO PRECIO € PIEZAS CAJA
Recomendado

RECAMBIOS MINICANAL DE ALUMINIO CON TAPA DE 65MM

	Tapa frontal para minicanal de aluminio 65x40mm aluminio anodizado	RTT003/8	53,90	1	ud.
	Perfil minicanal de aluminio 65x40mm aluminio anodizado	RTP001/8	85,66	1	ud.

CANAL PASACABLES

CANAL PASACABLES DE PVC





	Canal PVC pasacables 90x55mm blanco nieve	TS9055/9	16,16	12	m
	Retenedor para canal pasacables 90x55mm	TSA905501	1,12	20	ud.
	Ángulo plano 90x55mm blanco nieve	TKA101208/9	13,00	1	ud.
	Ángulo exterior variable 90x55mm blanco nieve	TKA102208/9	11,71	1	ud.
	Ángulo interior variable 90x55mm blanco nieve	TKA103208/9	11,71	1	ud.
	Tapa final 90x55mm blanco nieve	TSA905502/9	4,00	5	ud.
	Tapajuntas 90x55mm blanco nieve	TKA105208/9	3,82	5	ud.
	Derivación en T a canal 90x55mm blanco nieve	TKA106208/9	3,20	1	ud.
	Canal PVC pasacables 130x55mm blanco nieve	TS13055/9	24,26	12	m
	Retenedor para canal pasacables 130x55mm	TSA1305501	1,48	20	ud.
	Ángulo plano 130x55mm blanco nieve	TKA1305505/9	14,95	1	ud.
	Ángulo exterior variable 130x55mm blanco nieve	TKA1305506/9	14,07	1	ud.

DESCRIPCIÓN ARTÍCULO PRECIO € PIEZAS CAJA
Recomendado





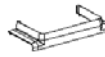

	Ángulo interior variable 130x55mm blanco nieve	TKA1305507/9	13,36	1	ud.
	Tapa final 130x55mm blanco nieve	TSA1305502/9	5,08	5	ud.
	Tapajuntas 130x55mm blanco nieve	TKA1305508/9	4,27	5	ud.
	Derivación en T a canal 90x55mm blanco nieve	TKA106208/9	3,20	1	ud.
	Derivación en T a canal 130x55mm blanco nieve	TKA106210/9	3,77	1	ud.
	Canal PVC pasacables 160x55mm blanco nieve	TS16055/9	28,54	12	m
	Retenedor para canal pasacables 160x55mm	TSA1605501	1,79	20	ud.
	Ángulo plano 160x55mm blanco nieve	TKA101212/9	20,61	1	ud.
	Ángulo exterior variable 160x55mm blanco nieve	TKA1605506/9	15,62	1	ud.
	Ángulo interior variable 160x55mm blanco nieve	TKA1605507/9	15,62	1	ud.
	Tapa final 160x55mm blanco nieve	TSA1605502/9	6,07	5	ud.
	Tapajuntas 160x55mm blanco nieve	TKA105212/9	5,67	5	ud.
	Derivación en T a canal 90x55mm blanco nieve	TKA106208/9	3,20	1	ud.
	Derivación en T a canal 130x55mm blanco nieve	TKA106210/9	3,77	1	ud.
	Derivación en T a canal 160x55mm blanco nieve	TKA106212/9	4,39	1	ud.
	Canal PVC pasacables 185x55mm blanco nieve	TS18555/9	34,36	8	m
	Retenedor para canal pasacables 185x55mm	TSA1855501	2,09	20	ud.
	Ángulo plano 185x55mm blanco nieve	TKA101214/9	21,68	1	ud.
	Ángulo exterior 185x55mm blanco nieve	TKA1855506/9	18,21	1	ud.

CONECTIVIDAD







SIMON K45

DESCRIPCIÓN	ARTÍCULO	PRECIO € <small>Recomendado</small>	PIEZAS CAJA
 Ángulo interior 185x55mm blanco nieve	TKA1855507/9	16,53	1 ud.
 Tapa final 185x55mm blanco nieve	TSA1855502/9	6,71	5 ud.
 Tapajuntas 185x55mm blanco nieve	TKA105214/9	5,90	5 ud.
 Derivación en T a canal 90x55mm blanco nieve	TKA106208/9	3,20	1 ud.
 Derivación en T a canal 130x55mm blanco nieve	TKA106210/9	3,77	1 ud.
 Derivación en T a canal 160x55mm blanco nieve	TKA106212/9	4,39	1 ud.

ACCESORIOS CANAL PASACABLES PARA MECANISMOS UNIVERSALES



 Bastidor y marco para mecanismo CIMA canal 160x55mm pasacable	TSA1605503/9	6,57	10 ud.
 Bastidor y marco para mecanismo CIMA canal 130x55mm pasacable	TSA1305503/9	5,85	10 ud.
 Bastidor y marco para mecanismo CIMA canal 90x55mm pasacable	TSA905503/9	5,65	10 ud.
 Bastidor y marco para mecanismo universal canal 90x55mm pasacable blanco nieve	TSA905504/9	5,85	10 ud.
 Bastidor y marco para mecanismo universal canal 130x55mm pasacable blanco nieve	TSA1305504/9	6,10	10 ud.
 Bastidor y marco para mecanismo universal canal 160x55mm pasacable blanco nieve	TSA1605504/9	7,29	10 ud.



ACCESORIOS FUNCIONALES PARA CANAL PASACABLES PVC

 Adaptador para schuko formato CIMA y MEC de protección	TSA008	6,14	20 ud.
 Separador interior 55mm tramo de 1m	TSA001	4,54	24 ud.
 Perfil de unión	TSA002	1,50	10 ud.
 Derivador de cable exterior	TSA003	5,30	1 ud.
 Derivación a minicanal (10x22mm 20x30mm 20x50mm 40x60 mm) blanco nieve	TKA107/9	4,59	1 ud.
 Radio de curvatura plano	TKA108	7,40	1 ud.
 Radio de curvatura exterior	TKA109	11,82	1 ud.





DESCRIPCIÓN	ARTÍCULO	PRECIO € <small>Recomendado</small>	PIEZAS CAJA
-------------	----------	--	----------------

CANAL PASACABLES DE ALUMINIO

 Canal pasacable de aluminio 90x55	TS9055/8	62,12	12 m
 Ángulo plano 90x55mm aluminio pintado	TKA101208/8	26,83	1 ud.
 Ángulo exterior variable 90x55mm aluminio pintado	TKA102208/8	23,52	1 ud.
 Ángulo interior variable 90x55mm aluminio pintado	TKA103208/8	23,52	1 ud.
 Tapa final 90x55mm aluminio pintado	TKA905502/8	9,98	5 ud.
 Tapajuntas 90x55mm aluminio pintado	TKA105208/8	8,36	5 ud.
 Derivación en T a canal 90x55mm aluminio pinTado	TKA106208/8	7,57	1 ud.
 Radio curvatura ángulo plano	TKA108	7,40	1 ud.
 Radio curvatura ángulo exterior	TKA109	11,82	1 ud.
 Canal pasacable de aluminio 130x55	TS13055/8	78,33	12 m
 Ángulo plano 130x55mm aluminio pintado	TKA1305505/8	33,42	1 ud.
 Ángulo exterior variable 130x55mm aluminio pintado	TKA1305506/8	24,20	1 ud.
 Ángulo interior variable 130x55mm aluminio pintado	TKA1305507/8	24,20	1 ud.
 Tapa final 130x55mm aluminio pintado	TKA1305502/8	10,58	5 ud.
 Tapajuntas 130x55mm aluminio pintado	TKA1305508/8	8,66	5 ud.
 Derivación en T a canal 90x55mm aluminio pintado	TKA106208/8	7,57	1 ud.
 Derivación en T a canal 130x55mm aluminio pintado	TKA106210/8	8,35	1 ud.

DESCRIPCIÓN	ARTÍCULO	PRECIO € Recomendado	PIEZAS CAJA
 Radio curvatura ángulo plano	TKA108	7,40	1 ud.
 Radio curvatura ángulo exterior	TKA109	11,82	1 ud.

















ACCESORIOS CANAL PASACABLES DE ALUMINIO

 Separador interior 55m tramo de 1m	TSA001	4,54	24 ud.
 Perfil de unión pasacable	TSA002	1,50	10 ud.
 Cable con conector faston para unión de tierra 120mm	TKA904	2,14	10 ud.
 Adaptador enlazable para mecanismos universales	TSA007	9,78	5 ud.
 Marco embellecedor y bastidor Simon 500 Cima	52550900-030	4,00	10 ud.
	52550900-038	4,07	
	52550900-033	9,77	

CANAL CLIPAJE DIRECTO K45

















CANAL CABLOMAX DE PVC K45







 Canal Cablomag de PVC 130x55mm K45 blanco nieve	TK02103/9	42,39	8 m
 Ángulo plano Cablomag de 130x55mm ascendente blanco nieve	TKA011210/9	27,48	1 ud.
 Ángulo plano Cablomag de 130x55mm descendente blanco nieve	TKA021210/9	27,48	1 ud.
 Ángulo exterior variable Cablomag 130x55mm blanco nieve	TKA002210/9	18,00	1 ud.
 Ángulo interior variable Cablomag 130x55mm blanco nieve	TKA003210/9	16,50	1 ud.
 Tapa final Cablomag 130x55mm blanco nieve	TKA004210/9	6,87	5 ud.
 Tapajuntas Cablomag 130x55mm blanco nieve	TKA005210/9	5,09	5 ud.

DESCRIPCIÓN	ARTÍCULO	PRECIO € Recomendado	PIEZAS CAJA
 Derivación en "T" Cablomag blanco nieve	TKA0062/9	17,81	1 ud.
 Canal Cablomag de PVC 170x55mm K45 blanco nieve	TK02133/9	46,82	8 m
 Ángulo plano Cablomag de 170x55mm ascendente blanco nieve	TKA011213/9	32,96	1 ud.
 Ángulo plano Cablomag de 170x55mm descendente blanco nieve	TKA021213/9	32,96	1 ud.
 Ángulo exterior variable Cablomag 170x55mm blanco nieve	TKA002213/9	21,45	1 ud.
 Ángulo interior variable Cablomag 170x55mm blanco nieve	TKA003213/9	19,64	1 ud.
 Tapa final Cablomag 170x55mm blanco nieve	TKA004213/9	8,17	5 ud.
 Tapajuntas Cablomag 170x55mm blanco nieve	TKA005213/9	6,81	5 ud.
 Derivación en "T" Cablomag blanco nieve	TKA0062/9	17,81	1 ud.
 Canal Cablomag de PVC 210x55mm K45 blanco nieve	TK02163/9	49,94	8 m
 Ángulo plano Cablomag 210x55mm ascendente blanco nieve	TKA011216/9	38,39	1 ud.
 Ángulo plano Cablomag 210x55mm descendente blanco nieve	TKA021216/9	38,39	1 ud.
 Ángulo exterior variable Cablomag 210x55mm blanco nieve	TKA002216/9	23,90	1 ud.
 Ángulo interior variable Cablomag 210x55mm blanco nieve	TKA003216/9	22,72	1 ud.
 Tapa final Cablomag 210x55mm blanco nieve	TKA004216/9	8,84	5 ud.
 Tapajuntas Cablomag 210x55mm blanco nieve	TKA005216/9	7,56	5 ud.

CONECTIVIDAD

SIMON K45









DESCRIPCIÓN	ARTÍCULO	PRECIO € Recomendado	PIEZAS CAJA
CANAL CABLOMAX DE ALUMINIO K45			
 Canal Cablomag de aluminio 130x55mm K45 aluminio anodizado	TK01103/8	63,15	8 m
 Ángulo plano Cablomag de 130x55mm ascendente aluminio anodizado	TKA011110/8	43,45	1 ud.
 Ángulo plano Cablomag de 130x55mm descendente aluminio anodizado	TKA021110/8	43,45	1 ud.
 Ángulo exterior variable Cablomag 130x55mm aluminio	TKA002210/8	25,85	1 ud.
 Ángulo interior variable Cablomag 130x55mm aluminio	TKA003210/8	25,56	1 ud.
 Tapa final Cablomag 130x55mm aluminio	TKA004210/8	9,80	5 ud.
 Tapajuntas Cablomag 130x55mm aluminio	TKA005210/8	7,17	5 ud.
 Derivación en "T" Cablomag aluminio anodizado	TKA0061/8	26,96	1 ud.
 Canal Cablomag de aluminio 170x55mm K45 aluminio anodizado	TK01133/8	70,98	8 m
 Ángulo plano Cablomag de 170x55mm ascendente aluminio anodizado	TKA011113/8	54,74	1 ud.
 Ángulo plano Cablomag de 170x55mm descendente aluminio anodizado	TKA021113/8	54,74	1 ud.
 Ángulo exterior variable Cablomag 170x55mm aluminio	TKA002213/8	30,81	1 ud.
 Ángulo interior variable Cablomag 170x55mm aluminio	TKA003213/8	29,03	1 ud.
 Tapa final Cablomag 170x55mm aluminio	TKA004213/8	12,55	5 ud.
 Tapajuntas Cablomag 170x55mm aluminio	TKA005213/8	11,16	5 ud.
 Derivación en "T" Cablomag aluminio anodizado	TKA0061/8	26,96	1 ud.
 Canal Cablomag de aluminio 210x55mm K45 aluminio anodizado	TK01163/8	77,72	8 m

















DESCRIPCIÓN	ARTÍCULO	PRECIO € Recomendado	PIEZAS CAJA
 Ángulo plano Cablomag de 210x55mm ascendente aluminio anodizado	TKA011216/8	60,83	1 ud.
 Ángulo plano Cablomag de 210x55mm descendente aluminio anodizado	TKA021216/8	60,83	1 ud.
 Ángulo exterior variable Cablomag 210x55mm aluminio	TKA002216/8	34,99	1 ud.
 Ángulo interior variable Cablomag 210x55mm aluminio	TKA003216/8	31,40	1 ud.
 Tapa final Cablomag 210x55mm aluminio	TKA004216/8	13,13	5 ud.
 Tapajuntas Cablomag 210x55mm aluminio	TKA005216/8	12,00	5 ud.



















RECAMBIOS CANAL CABLOMAX DE ALUMINIO K45

 Tapa frontal para canal Cablomag de aluminio 2m. aluminio anodizado	RTT002/8	34,39	1 ud.
---	-----------------	-------	-------

CANAL DE PVC K45











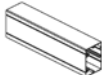



 Canal de PVC 90x55mm K45 de 1 compartimento blanco nieve	TK12081/9	17,29	12 m
 Ángulo plano 90x55mm blanco nieve	TKA101208/9	13,00	1 ud.
 Ángulo exterior variable 90x55mm blanco nieve	TKA102208/9	11,71	1 ud.
 Ángulo interior variable 90x55mm blanco nieve	TKA103208/9	11,71	1 ud.
 Tapa final 90x55mm blanco nieve	TKA905502/9	4,00	5 ud.
 Tapajuntas 90x55mm blanco nieve	TKA105208/9	3,82	5 ud.
 Derivación en "T" a canal 90x55mm blanco nieve	TKA106208/9	3,20	1 ud.
 Derivación minicanal blanco nieve	TKA107/9	4,59	1 ud.
 Radio curvatura Ángulo plano	TKA108	7,40	1 ud.

















DESCRIPCIÓN	ARTÍCULO	PRECIO € Recomendado	PIEZAS CAJA
 Radio curvatura Ángulo exterior	TKA109	11,82	1 ud.
 Canal de PVC 130x55mm K45 de 2 compartimentos blanco nieve	TK12102/9	21,09	12 m
 Ángulo plano 130x55mm blanco nieve	TKA1305505/9	14,95	1 ud.
 Ángulo exterior variable 130x55mm blanco nieve	TKA1305506/9	14,07	1 ud.
 Ángulo interior variable 130x55mm blanco nieve	TKA1305507/9	13,36	1 ud.
 Tapa final 130x55mm blanco nieve	TKA1305502/9	4,23	5 ud.
 Tapajuntas 130x55mm blanco nieve	TKA1305508/9	4,27	5 ud.
 Derivación en "T" a canal 90x55mm blanco nieve	TKA106208/9	3,20	1 ud.
 Derivación en "T" a canal 130x55mm blanco nieve	TKA106210/9	3,77	1 ud.
 Derivación minicanal blanco nieve	TKA107/9	4,59	1 ud.
 Radio curvatura ángulo plano	TKA108	7,40	1 ud.
 Radio curvatura ángulo exterior	TKA109	11,82	1 ud.
 Canal de PVC 160x55mm K45 de 2 compartimentos blanco nieve	TK12122/9	32,16	12 m
 Ángulo plano 160x55mm blanco nieve	TKA101212/9	20,61	1 ud.
 Ángulo exterior variable 160x55mm blanco nieve	TKA1605506/9	15,62	1 ud.
 Ángulo interior variable 160x55mm blanco nieve	TKA1605507/9	15,62	1 ud.
 Tapa final 160x55mm blanco nieve	TKA1605502/9	4,88	5 ud.



















DESCRIPCIÓN	ARTÍCULO	PRECIO € Recomendado	PIEZAS CAJA
 Tapajuntas 160x55mm blanco nieve	TKA105212/9	5,67	5 ud.
 Derivación en "T" a canal 90x55mm blanco nieve	TKA106208/9	3,20	1 ud.
 Derivación en "T" a canal 130x55mm blanco nieve	TKA106210/9	3,77	1 ud.
 Derivación en "T" a canal 160x55mm blanco nieve	TKA106212/9	4,39	1 ud.
 Derivación minicanal blanco nieve	TKA107/9	4,59	1 ud.
 Radio curvatura ángulo plano	TKA108	7,40	1 ud.
 Radio curvatura ángulo exterior	TKA109	11,82	1 ud.
 Canal de PVC 185x55mm K45 de 3 compartimentos blanco nieve	TK12143/9	34,84	6 m
 Ángulo plano 185x55mm blanco nieve	TKA101214/9	21,68	1 ud.
 Ángulo exterior variable 185x55mm blanco nieve	TKA1855506/9	18,21	1 ud.
 Ángulo interior variable 185x55mm blanco nieve	TKA1855507/9	16,53	1 ud.
 Tapa final 185x55mm blanco nieve	TKA1855502/9	5,37	5 ud.
 Tapajuntas de 185x55mm blanco nieve	TKA105214/9	5,90	5 ud.
 Derivación en "T" a canal 90x55mm blanco nieve	TKA106208/9	3,20	1 ud.
 Derivación en "T" a canal 130x55mm blanco nieve	TKA106210/9	3,77	1 ud.
 Derivación en "T" a canal 160x55mm blanco nieve	TKA106212/9	4,39	1 ud.
 Derivación minicanal blanco nieve	TKA107/9	4,59	1 ud.
 Radio curvatura ángulo plano	TKA108	7,40	1 ud.
 Radio curvatura ángulo exterior	TKA109	11,82	1 ud.

CONECTIVIDAD

SIMON K45





DESCRIPCIÓN	ARTÍCULO	PRECIO € Recomendado	PIEZAS CAJA
RECAMBIOS CANAL DE PVC K45			
 Tapa frontal para canal de PVC K45 2m blanco nieve	RTT001/9	23,39	1 ud.
CANAL DE ALUMINIO K45			
 Canal de Aluminio 70x50 mm K45 de 1 Compartimento Aluminio Anodizado	TK11071/8	61,49	16 m
 Accesorio Universal (Ángulo Plano y Derivación) 70x50 mm Acero Inoxidable	TKA101307/8	29,85	1 ud.
 Ángulo Exterior Fijo 70x50 mm Acero Inoxidable	TKA102307/8	19,04	1 ud.
 Ángulo Interior Fijo para Canal 70x50 mm Acero Inoxidable	TKA103307/8	18,87	1 ud.
 Tapa Final 70x50 mm Acero Inoxidable	TKA104307/8	10,04	5 ud.
 Tapa Final 70x50 mm Gris Claro	TKA104207/24	9,51	5 ud.
 Tapajuntas 70x50 mm Acero Inoxidable	TKA105307/8	9,47	1 ud.
 Canal de Aluminio 90x55 mm K45 de 1 Compartimento Aluminio Anodizado	TK11081/8	66,43	12 m
 Ángulo Plano 90x55 mm Aluminio Pintado	TKA101208/8	26,83	1 ud.
 Ángulo Exterior Variable 90x55 mm Aluminio Pintado	TKA102208/8	23,52	1 ud.
 Ángulo Interior Variable 90x55 mm Aluminio Pintado	TKA103208/8	23,52	1 ud.
 Tapa Final 90x55 mm Aluminio Pintado	TKA905502/8	9,98	5 ud.
 Tapajuntas 90x55 mm Aluminio Pintado	TKA105208/8	8,36	5 ud.
 Derivación en "T" a Canal 90x55 mm Aluminio Pintado	TKA106208/8	7,57	1 ud.

DESCRIPCIÓN	ARTÍCULO	PRECIO € Recomendado	PIEZAS CAJA
 Radio Curvatura Ángulo Plano	TKA108	7,40	1 ud.
 Radio Curvatura Ángulo Exterior	TKA109	11,82	1 ud.
 Canal de aluminio 130x55mm K45 de 2 compartimentos aluminio anodizado	TK11102/8	74,32	12 m
 Ángulo plano 130x55mm aluminio pintado	TKA1305505/8	33,42	1 ud.
 Ángulo exterior variable 130x55mm aluminio pintado	TKA1305506/8	24,20	1 ud.
 Ángulo interior variable 130x55mm aluminio pintado	TKA1305507/8	24,20	1 ud.
 Tapa final 130x55mm aluminio pintado	TKA1305502/8	10,58	5 ud.
 Tapajuntas 130x55mm aluminio pintado	TKA1305508/8	8,66	5 ud.
 Derivación en "T" a canal 90x55mm aluminio pintado	TKA106208/8	7,57	1 ud.
 Derivación en "T" a canal 130x55mm aluminio pintado	TKA106210/8	8,35	1 ud.
 Radio curvatura ángulo plano	TKA108	7,40	1 ud.
 Radio curvatura ángulo exterior	TKA109	11,82	1 ud.
 Canal de aluminio 160x55mm K45 de 2 compartimentos aluminio anodizado	TK11122/8	99,92	8 m
 Ángulo plano 160x55mm aluminio pintado	TKA101212/8	41,93	1 ud.
 Ángulo exterior variable de 160x55mm aluminio pintado	TKA1605506/8	27,07	1 ud.
 Ángulo interior variable de 160x55mm aluminio pintado	TKA1605507/8	27,07	1 ud.
 Tapa final 160x55mm aluminio pintado	TKA1605502/8	12,31	5 ud.

DESCRIPCIÓN	ARTÍCULO	PRECIO € Recomendado	PIEZAS CAJA	ud.
 Tapajuntas 160x55mm aluminio pintado	TKA105212/8	11,61	5	ud.
 Derivación en "T" a canal 90x55mm aluminio pintado	TKA106208/8	7,57	1	ud.
 Derivación en "T" a canal 130x55mm aluminio pintado	TKA106210/8	8,35	1	ud.
 Derivación en "T" a canal 160x55mm aluminio pintado	TKA106212/8	8,40	1	ud.
 Radio curvatura ángulo plano	TKA108	7,40	1	ud.
 Radio curvatura ángulo exterior	TKA109	11,82	1	ud.
 Canal de aluminio 185x55mm K45 de 3 compartimentos aluminio anodizado	TK11143/8	104,39	6	m
 Ángulo plano 185x55mm aluminio pintado	TKA101214/8	46,75	1	ud.
 Ángulo exterior variable 185x55mm aluminio pintado	TKA185506/8	36,67	1	ud.
 Ángulo interior variable 185x55mm aluminio pintado	TKA185507/8	36,49	1	ud.
 Tapa final 185x55mm aluminio pintado	TKA185502/8	13,95	5	ud.
 Tapajuntas 185x55mm aluminio pintado	TKA105214/8	13,07	5	ud.
 Derivación en "T" a canal 90x55mm aluminio pintado	TKA106208/8	7,57	1	ud.
 Derivación en "T" a canal 130x55mm aluminio pintado	TKA106210/8	8,35	1	ud.
 Derivación en "T" a canal 160x55mm aluminio pintado	TKA106212/8	8,40	1	ud.
 Radio curvatura ángulo plano	TKA108	7,40	1	ud.
 Radio curvatura ángulo exterior	TKA109	11,82	1	ud.
RECAMBIOS CANAL DE ALUMINIO K45				
 Tapa canal de aluminio K45 2m aluminio anodizado	RTT001/8	43,35	1	ud.
 Perfil canal de aluminio K45 70x55mm aluminio anodizado	RTP002/8	92,61	1	ud.











DESCRIPCIÓN	ARTÍCULO	PRECIO € Recomendado	PIEZAS CAJA	ud.
-------------	----------	-------------------------	----------------	-----

ACCESORIOS CANAL (PVC Y ALUMINIO) MECANISMOS K45 CLIPAJE DIRECTO



 Clip rigidizador para canal K45 blanco nieve	TKA901/9	2,26	20	ud.
 Separador interior 45mm tramo de 1m	TKA902	4,70	8	ud.
 Pasador unión de perfiles	TKA903	2,14	10	ud.
 Cable con conector faston para unión de tierra 120mm	TKA904	2,14	10	ud.

CANAL DE SUELO



SISTEMA DCS (SISTEMA DE DISTRIBUCIÓN DE CABLEADO EN SUPERFICIE PARA SUELO EN INTERIORES)

 Canal DCS de aluminio de suelo 85x18mm aluminio anodizado	TF11172/8	32,96	8	m
 Canal DCS monoblock de aluminio de suelo 85x18mm aluminio anodizado	TF21172/8	38,06	11	m
 Tapa final metálica 85x18mm aluminio anodizado	TFA904417/8	10,31	5	ud.
 Derivación de DCS 85x18mm a canal perimetral aluminio 65x20 aluminio anodizado	TFA965417/8	20,90	1	ud.
 Canal DCS de aluminio de suelo 130x18mm aluminio anodizado	TF11183/8	50,53	8	m
 Canal DCS monoblock de aluminio de suelo 130x18mm aluminio anodizado	TF21183/8	55,28	11	m
 Tapa final metálica 130x18mm aluminio anodizado	TFA904418/8	17,06	5	ud.
 Derivación de DCS 130x18mm a canal perimetral aluminio 65x20 aluminio anodizado	TFA965418/8	25,01	1	ud.
 Derivación de DCS 130x18mm a canal perimetral aluminio 70x50 aluminio anodizado	TFA970418/8	26,58	1	ud.
 Canal DCS de aluminio de suelo 240x34mm aluminio anodizado	TF11193/8	162,53	4	m
 Tapa final metálica 240x34mm aluminio anodizado	TFA904419/8	22,44	5	ud.

ZÓCALOS PARA UNIÓN A CANAL DE SUELO DCS 85X18 MM Y 130X18 MM

DESCRIPCIÓN	ARTÍCULO	PRECIO € Recomendado	PIEZAS CAJA
 Zócalo metálico K45 con 4 pretroqueles para canal DCS de 85x18mm	KTA804/8	37,77	1 ud.
Zócalo K45 de 1 troquel de 130x18mm y 3 pretroqueles de 85x18mm	KTA813/8	37,77	1 ud.
Zócalo K45 2 troqueles 130x18mm a 180° y 2 pretroqueles 85x18mm	KTA822/8	37,77	1 ud.
Zócalo K45 2 troqueles 130x18mm a 90° y 2 pretroqueles 85x18mm	KTA8229/8	37,77	1 ud.
Zócalo K45 de 3 troqueles de 130x18mm y 1 pretroquel de 85x18mm	KTA831/8	37,77	1 ud.
 Tapa superior para zócalo K45 de distribución	KTA904/8	12,03	1 ud.
 Tapa zócalo K45 auxiliar para adaptar minicolumna ALK	ALKA02/8	13,15	1 ud.









ORGANIZADOR DE CABLEADO

 Organizador de cableado en rollo de 2 metros y aplicador de cables	TC250/0	37,89	1 ud.
 Organizador de cableado en bobinas de 20 metros	TC251/0	116,18	1 ud.
 Aplicador de cables para organizador de cables 25mm diámetro	TCA2501	5,18	1 ud.









ELECTROBLOCK - REGLETAS ELÉCTRICAS PARA ARMARIOS RACK DE 19"









ELECTROBLOCK TOMAS SCHUKO CON CABLE DE 2 M

 Electroblock 19" de 5 bases Schuko con cable	F1105/14	115,61	1
 Electroblock 19" de 6 bases Schuko con cable	F1106/6	125,29	1
	F1106/14	125,29	
 Electroblock 19" de 8 bases Schuko con cable	F1108/14	142,11	1
 Electroblock 19" de 9 bases Schuko con cable	F1109/14	148,46	1
 Electroblock 19" de 5 bases Schuko con cable e interruptor	F1115/14	119,73	1
	F1116/14	125,99	1
 Electroblock 19" de 6 bases Schuko con cable e interruptor	F1118/14	149,11	1
 Electroblock 19" de 8 bases Schuko con cable e interruptor	F1126/14	187,99	1
 Electroblock 19" de 6 bases Schuko con cable y magnetotérmico	F1136/14	236,54	1

ELECTROBLOCK TOMAS FRANCESAS CON CABLE DE 2 M

 Electroblock 19" de 5 bases francesas con cable	F2105/6	100,47	1
	F2105/14	100,47	
 Electroblock 19" de 6 bases francesas con cable	F2106/14	115,61	1
 Electroblock 19" de 8 bases francesas con cable	F2108/14	142,11	1
 Electroblock 19" de 9 bases francesas con cable	F2109/6	148,46	1
	F2109/14	148,46	
 Electroblock 19" de 5 bases francesas con cable e interruptor	F2115/14	119,73	1
 Electroblock 19" de 6 bases francesas con cable e interruptor	F2116/14	125,99	1
	F2118/6	149,11	1
 Electroblock 19" de 8 bases francesas con cable e interruptor	F2118/14	149,11	1
 Electroblock 19" de 6 bases francesas con cable y magnetotérmico	F2126/14	187,99	1
 Electroblock 19" de 6 bases francesas con cable y diferencial	F2136/14	236,54	1

ELECTROBLOCK TOMAS SCHUKO SIN CABLE

 Electroblock 19" de 5 bases Schuko	F1005/14	87,98	1
	F1006/14	107,84	1
 Electroblock 19" de 6 bases Schuko	F1008/14	121,04	1
 Electroblock 19" de 8 bases Schuko	F1009/14	142,11	1
 Electroblock 19" de 9 bases Schuko	F1015/14	100,47	1
 Electroblock 19" de 5 bases Schuko con interruptor	F1016/14	110,24	1
 Electroblock 19" de 6 bases Schuko con interruptor	F1018/14	138,70	1
 Electroblock 19" de 8 bases Schuko con interruptor	F1026/14	171,64	1
Electroblock 19" de 6 bases Schuko con magnetotérmico	F1036/14	226,98	1

DESCRIPCIÓN

ARTÍCULO PRECIO € PIEZAS CAJA
Recomendado

DESCRIPCIÓN

ARTÍCULO PRECIO € PIEZAS CAJA
Recomendado

ELECTROBLOCK TOMAS FRANCESAS SIN CABLE



	Electroblock 19" de 5 bases francesas	F2005/14	87,98	1
	Electroblock 19" de 6 bases francesas	F2006/6	107,84	1
		F2006/14	107,84	
	Electroblock 19" de 8 bases francesas	F2008/6	121,04	1
		F2008/14	121,04	
	Electroblock 19" de 9 bases francesas	F2009/14	142,11	1
	Electroblock 19" de 5 bases francesas con interruptor	F2015/14	139,01	1
	Electroblock 19" de 6 bases francesas con interruptor	F2016/14	110,24	1
	Electroblock 19" de 8 bases francesas con interruptor	F2018/14	149,11	1
	Electroblock 19" de 6 bases francesas con magnetotérmico	F2026/14	171,64	1
	Electroblock 19" de 6 bases francesas con diferencial	F2036/14	226,98	1

PANELES DE DISTRIBUCIÓN DE VOZ Y DATOS

PANELES INTEGRADOS

	Panel integrado 19" 1U 24 puertos RJ45 Cat.5e UTP	CP524U	194,17	1
	Panel integrado 19" 1U 24 puertos RJ45 Cat.6 UTP	CP624U	261,52	1
	Panel integrado 19" 1U 24 puertos RJ45 Cat.5e FTP (apantallados)	CP524F	331,44	1
	Panel integrado 19" 1U 24 puertos RJ45 Cat.6 FTP (apantallados)	CP624F	399,15	1

CONECTORES DE VOZ Y DATOS





	Conector RJ45 Cat.5e UTP	CJ545U	8,92	24
	Conector RJ45 Cat.5e FTP	CJ545FM	13,42	24
	Conector RJ45 Cat.6 UTP	CJ645U	12,26	24
	Conector RJ45 hembra-hembra Cat.6 UTP Keystone	CJ645UF	13,87	1
	Conector RJ45 Cat.6 FTP	CJ645FM	14,91	24
	Conector RJ45 Cat.6A FTP	CJ6A45F	15,07	24

CABLES DE DATOS

CABLES DE VOZ Y DATOS CON CUBIERTA DE PVC

	Cable voz y datos Cat.5e UTP PVC suministro en caja	CB531U	A consultar	305m
--	---	--------	-------------	------

CABLES DE VOZ Y DATOS CON CUBIERTA LSZH (LIBRE DE HALÓGENOS)

	Cable voz y datos Cat.5e UTP LSZH (sin halógenos) suministro en caja	CB530U	A consultar	305 m
	Cable voz y datos Cat.5e FTP (apantallado) LSZH (sin halógenos) suministro en caja	CB530F	A consultar	305 m
	Cable voz y datos Cat.6 UTP LSZH (sin halógenos) suministro en caja	CB630U	A consultar	305 m
	Cable voz y datos Cat.6 FTP (apantallado) LSZH (sin halógenos) suministro en bobina	CB650FD	A consultar	500 m
	Cable voz y datos Cat.6A FTP (apantallado) LSZH (sin halógenos) suministro en bobina	CB6A50FD	A consultar	500 m

LATIGUILLOS DE CONEXIÓN RJ45

CAT.6A FTP (APANTALLADOS)

	Latiguillo de 0,5m Cat.6A FTP	CL6A0F	11,68	5
	Latiguillo de 1m Cat.6A FTP	CL6A1F	13,35	5
	Latiguillo de 2m Cat.6A FTP	CL6A2F	15,91	5
	Latiguillo de 3m Cat.6A FTP	CL6A3F	18,41	5
	Latiguillo de 5m Cat.6A FTP	CL6A5F	23,71	5

CAT.6 FTP (APANTALLADOS)

	Latiguillo de 0,5m Cat.6 FTP	CL60F	10,10	5
	Latiguillo de 1m Cat.6 FTP	CL61F	11,54	5
	Latiguillo de 2m Cat.6 FTP	CL62F	13,75	5
	Latiguillo de 3m Cat.6 FTP	CL63F	15,91	5
	Latiguillo de 5m Cat.6 FTP	CL65F	20,50	5

CAT.6 UTP

	Latiguillo de 0,5m Cat.6 UTP	CL60U	9,11	5
	Latiguillo de 1m Cat.6 UTP	CL61U	10,25	5
	Latiguillo de 2m Cat.6 UTP	CL62U	12,47	5
	Latiguillo de 3m Cat.6 UTP	CL63U	14,92	5
	Latiguillo de 5m Cat.6 UTP	CL65U	19,70	5



CAT. 5 FTP (APANTALLADOS)

	Latiguillo de 0,5m Cat.5e FTP	CL50F	9,60	5
	Latiguillo de 1m Cat.5e FTP	CL51F	11,11	5
	Latiguillo de 2m Cat.5e FTP	CL52F	13,04	5
	Latiguillo de 3m Cat.5e FTP	CL53F	15,12	5
	Latiguillo de 5m Cat.5e FTP	CL55F	19,27	5



CAT. 5 UTP

	Latiguillo de 0,5m Cat.5e UTP	CL50U	6,03	5
	Latiguillo de 1m Cat.5e UTP	CL51U	7,17	5
	Latiguillo de 2m Cat.5e UTP	CL52U	9,11	5
	Latiguillo de 3m Cat.5e UTP	CL53U	11,25	5
	Latiguillo de 5m Cat.5e UTP	CL55U	15,12	5

HERRAMIENTAS DE SISTEMA DE CABLEADO ESTRUCTURADO

	Herramienta de inserción y corte IDC110 para paneles y conectores de voz y datos. hoja de inserción y corte incluida	CH100	67,22	1
	Recambio hoja de inserción y corte IDC110 para herramienta ch100	CH101	33,50	1

CONECTIVIDAD



DESCRIPCIÓN	ARTÍCULO	PRECIO € Recomendado	PIEZAS CAJA
 Herramienta profesional para crimpar RJ 4pins/6pins/8pins macho	CH104	104,44	1
 Herramienta pelacables de pares trenzados UTP/STP y coaxial de antena	CH106	45,32	1
 Alicates de precisión para corte de cable	CH108	41,39	1





Cableado eléctrico

SISTEMA DE CONEXIÓN RÁPIDA



CONEXIÓN RÁPIDA IEC320

 Placa K45 con 1 conector rápido macho IEC320	K305A/14	4,38	10
 Placa K45 con 1 conector rápido hembra IEC320	K306A/9 K306A/14	5,00 5,07	10
 Latiguillo eléctrico Schuko-IEC320 hembra 2m	KT18/14	6,02	1

PLACAS CON CONECTORES RÁPIDOS DE EMPOTRAR 3 POLOS

 Placa K45 2 conexión rápida macho 3p grafito-rojo grafito	KB18A/14	10,70	5
 Placa K45 1/2 mecanismo con 1 conector conexión rápida macho 3 polos	K121A/9 K121A/14	4,90 4,95	10
 Placa K45 1/2 mecanismo con 1 conector conexión rápida hembra 3 polos	K121B/9 K121B/14	5,33 5,38	10

PLACAS PARA CONECTORES RÁPIDOS DE EMPOTRAR 3 POLOS









 Placa K45 medio mecanismo para 1 conector conexión rápida macho o hembra 3 polos	K121/9 K121/14	1,84 1,87	20
 Placa K45 para 1 conector conexión rápida macho o hembra 3 polos	K18/9 K18/14	3,24 3,30	20

DESCRIPCIÓN	ARTÍCULO	PRECIO € Recomendado	PIEZAS CAJA
 Placa K45 para 2 conectores conexión rápida macho o hembra 3 polos	KB18/9 KB18/14	3,24 3,30	20

PLACAS PARA CONECTORES RÁPIDOS DE EMPOTRAR 5 POLOS



 Placa K45 2 mecanismos para 1 conector conexión rápida macho o hembra 5 polos	K18W5/9 K18W5/14	5,57 5,68	10
---	-----------------------------------	--------------	----









CONECTORES

 Conector rápido de empotrar hembra 3 polos conexión por cepo	CR0001/2 CR0001/6 CR0001/9 CR0001/14	2,89 2,89 2,84 2,84	10
 Conector rápido de empotrar macho 3 polos conexión por cepo	CR0002/2 CR0002/6 CR0002/9 CR0002/14	2,89 2,89 2,84 2,84	10
 Conector rápido aéreo hembra 3 polos conexión por cepo	CR0003/2 CR0003/6 CR0003/9 CR0003/14	3,86 3,86 3,85 3,85	10
 Conector rápido aéreo macho de 3 polos conexión por tornillo	CR0004/2 CR0004/6 CR0004/9 CR0004/14	3,86 3,86 3,85 3,85	10
 Conector rápido de empotrar hembra 5 polos conexión por cepo	CR5001/14	5,11	5
 Conector rápido de empotrar macho 5 polos conexión por cepo	CR5002/14	5,11	5
 Conector rápido aéreo hembra de 5 polos conexión por tornillo	CR5003/14	9,39	5
 Conector rápido aéreo macho de 5 polos conexión por tornillo	CR5004/14	9,39	5

Los Conectores Rápidos /6 no son compatibles con los /9 /14 para evitar confusiones en la Instalación.

LATIGUILLOS DE CONEXIÓN RÁPIDA DE 3 POLOS

 Latiguillo conexión rápida hembra-Schuko 3 polos. 2m. PVC sección 3x1,5mm2	CR1020/9 CR1020/14	14,90 14,90	5
 Latiguillo conexión rápida hembra-Schuko 3 polos. 2m. cable RZ - 0,6/1Kv. libre de halógenos. sección 3x2,5mm2	CR6020/6 CR6020/9 CR6020/14	22,59 22,52 22,52	5
 Latiguillo conexión rápida hembra-extremo libre 3 polos. 2m. cable RZ - 0,6/1Kv. libre de halógenos. sección 3x2,5mm2	CR4020/6 CR4020/9 CR4020/14	19,13 18,68 18,68	5

DESCRIPCIÓN	ARTÍCULO	PRECIO € Recomendado	PIEZAS CAJA	DESCRIPCIÓN	ARTÍCULO	PRECIO € Recomendado	PIEZAS CAJA
	Latiguillo conexión rápida macho-hembra 3 polos. 1m. cable RZ - 0,6/1Kv. libre de halógenos. sección 3x2,5mm2	CR2010/6	13,47	5			
		CR2010/9	13,46				
		CR2010/14	13,46				
	Latiguillo conexión rápida macho-hembra 3 polos. 2m. cable RZ - 0,6/1Kv. libre de halógenos. sección 3x2,5mm2	CR2020/6	20,61	5			
		CR2020/9	20,60				
		CR2020/14	20,60				
	Latiguillo conexión rápida macho-hembra 3 polos. 3m. cable RZ - 0,6/1Kv. libre de halógenos. sección 3x2,5mm2	CR2030/6	27,14	5			
		CR2030/9	27,13				
		CR2030/14	27,13				
	Latiguillo conexión rápida macho-hembra 3 polos. 4m. cable RZ - 0,6/1Kv. libre de halógenos. sección 3x2,5mm2	CR2040/6	33,70	5			
		CR2040/9	33,69				
		CR2040/14	33,69				
	Latiguillo conexión rápida macho-hembra 3 polos. 5m. cable RZ - 0,6/1Kv. libre de halógenos. sección 3x2,5mm2	CR2050/6	40,25	5			
		CR2050/9	40,24				
		CR2050/14	40,24				
	Latiguillo conexión rápida macho-hembra 3 polos. 6m. cable RZ - 0,6/1Kv. libre de halógenos. sección 3x2,5mm2	CR2060/6	46,82	5			
		CR2060/9	46,79				
		CR2060/14	46,79				
	Latiguillo conexión rápida macho-hembra 3 polos. 7m. cable RZ - 0,6/1Kv. libre de halógenos. sección 3x2,5mm2	CR2070/6	53,37	5			
		CR2070/9	53,36				
		CR2070/14	53,36				
	Latiguillo conexión rápida macho-hembra 3 polos. 8m. cable RZ - 0,6/1Kv. libre de halógenos. sección 3x2,5mm2	CR2080/6	59,95	5			
		CR2080/9	59,94				
		CR2080/14	59,94				

Precios Latiguillos sujetos a variaciones del precio del Cobre.
 Los Conectores Rápidos /6 no son compatibles con los /9 /14 para evitar confusiones en la Instalación.

DERIVADORES

	Pieza "T" de derivación 3 polos 1 entrada 2 salidas	CR7312/14	6,25	10
---	---	-----------	------	----

CAJAS DISTRIBUIDORAS





1 circuito con 1 entrada de 3 polos y 4 salidas de 3 polos	49114000-039	47,22	1
1 circuito con 1 entrada de 3 polos y 5 salidas de 3 polos	49115000-039	54,30	1
1 circuito con 1 entrada de 3 polos y 6 salidas de 3 polos	49116000-039	60,73	1
1 circuito con 1 entrada de 3 polos y 7 salidas de 3 polos	49117000-039	67,54	1
1 circuito con 1 entrada de 3 polos y 8 salidas de 3 polos	49118000-039	74,14	1
1 circuito con 1 entrada de 3 polos y 9 salidas de 3 polos	49119000-039	80,73	1
1 circuito para SAI con 1 entrada de 3 polos y 5 salidas de 3 polos	49120500-039	54,34	1
1 circuito para SAI con 1 entrada de 3 polos y 7 salidas de 3 polos	49120700-039	67,55	1
2 circuitos con 2 entradas de 3 polos y 3 salidas de 3 polos	49133300-039	76,81	1
2 circuitos con 2 entradas de 3 polos y 4 salidas de 3 polos	49134400-039	87,78	1
1 circuito con 1 entrada de 5 polos y 3 salidas de 3 polos y 1 salida de 5 polos	49143010-039	65,98	1
1 circuito con 1 entrada de 5 polos y 6 salidas de 3 polos y 1 salida de 5 polos	49146010-039	86,85	1

ORGANIZADOR DE CABLEADO

Kit compuesto por organizador de cableado para 4 puestos de trabajo	49204004-030	44,66	1
	49204004-038	44,66	1

COMPATIBILIDAD PLACAS DE VOZ Y DATOS CON CONECTORES RJ45 SIMON 400

PLACAS PARA CONECTORES DE OTRAS MARCAS

	Con guardapolvo		Sin guardapolvo	
	1 conector	2 conectores	1 conector	2 conectores
FABRICANTES				
SIMON	40000085	40000089	40000185	40000189
3M®				
Volition OCK®: RJ25, K5e, K6			40011185	40011189
OCK5EU8, OCK5EF8	40000085	40000089	40000185	40000189
BeldenCDT® (NORDX®)				
Giga Flex MDVO	40013085	40013089		
Giga Flex Keystone	40000085	40000089	40000185	40000189
BRAND-REX® (BICC®)	40000085	40000089	40000185	40000189
COMMSCOPE® (1375055-2)	40000085	40000089	40000185	40000189
DATWYLER® (418071)	40000085	40000089	40000185	40000189
ERSYS®	40000085	40000089	40000185	40000189
EXCEL®				
100-011, 100-181, 100-182, 100-215	40000085	40000089	40000185	40000189
GENERAL CABLE®	40000085	40000089	40000185	40000189
GIGAMEDIA® (GGM 621030200)	40000085	40000089	40000185	40000189
INFRA +®	40015085	40015089	40015185	40015189
ITT CANNON®	40016085	40016089		
TE connectivity® (TYCO®, AMP netconnect®, KRONE®)				
8-406372-2, 1375055-2, 2153001-1	40000085	40000089	40000185	40000189
Serie KM8 keystone	40000085	40000089	40000185	40000189
Serie HK keystone	40017085			
Standard 110 SL110 y SL toolless	40000085	40000089	40000185	40000189
216000 y 216005		40000089	40000185	40000189
MOLEX®	40000085	40000089	40000185	40000189
NEXANS® (LAN mark®-5 eVo, LAN mark®-6 eVo)	40018085		40018185	
ORTRONICS®				
Clarity TechChoice Keystone	40000085	40000089	40000185	40000189
PANDUIT®				
Serie MINI-COM	40019085	40019089	40019185	40019189
Serie NETKEY	40000085	40000089	40000185	40000189
R&M® (REICHLÉ DE MASSARI®)				
Serie CLASSIC Cat5e (R925371, R925370)				
Serie STAR Cat6 (R302373, R302372)				
Serie ADVANCED Cat6A Keystone (R509508, R509509)			40000185	
813512	40000085	40000089	40000185	40000189
RIT®	40000085	40000089	40000185	40000189
SYSTIMAX® (AVAYA®) (ATT®)	40000085	40000089	40000185	40000189

COMPATIBILIDAD PLACAS DE VOZ Y DATOS SIMON 500 CIMA





PLACAS INCLINADAS PARA CONECTORES DE OTRAS MARCAS

FABRICANTES	Con guardapolvo		Sin guardapolvo	
	1 conector	2 conectores	1 conector	2 conectores
Acabados disponibles	-030 -033 -038		-030 -033 -038	
SIMON	5000081.. + 1 MD67	5000086.. + 2 MD67	50000181.. + 1 MD67	50000186.. + 2 MD67
3M® (Volition OCK®: RJ25, K5e, K6)	-	-	50000181.. + 1 MD45	50000186.. + 2 MD45
AMP netconnect® (TYCO®)				
Standard 110 SL110 y SL toolless	5000081.. + 1 MD67	5000086.. + 2 MD67	50000181.. + 1 MD67	50000186.. + 2 MD67
216000 y 216005	5000081.. + 1 MD64	5000086.. + 2 MD64	50000181.. + 1 MD64	50000186.. + 2 MD64
BeldenCDT® (NORDX®)				
Giga Flex MDVO	5000081.. + 1 MD68	5000086.. + 2 MD68	50000181.. + 1 MD68	50000186.. + 2 MD68
Giga Flex Keystone	5000081.. + 1 MD64	5000086.. + 2 MD64	50000181.. + 1 MD64	50000186.. + 2 MD64
BRAND-REX® (BICC®)	5000081.. + 1 MD67	5000086.. + 2 MD67	50000181.. + 1 MD67	50000186.. + 2 MD67
CORNING® (SIEMENS®)				
S500k y XS500	5000081.. + 1 MD67	5000086.. + 2 MD67	50000181.. + 1 MD67	50000186.. + 2 MD67
ERSYS®	5000081.. + 1 MD64	5000086.. + 2 MD64	50000181.. + 1 MD64	50000186.. + 2 MD64
ADC KRONE®				
Serie KM8 keystone	5000081.. + 1 MD64	5000086.. + 2 MD64	50000181.. + 1 MD64	50000186.. + 2 MD64
Serie HK keystone	5000081.. + 1 MD64	5000086.. + 2 MD64	50000181.. + 1 MD64	50000186.. + 2 MD64
MOLEX®	5000081.. + 1 MD64	5000086.. + 2 MD64	50000181.. + 1 MD64	50000186.. + 2 MD64
NEXANS® (LAN mark®-5 eVo, LAN mark®-6 eVo)	5000081.. + 1 MD85	5000086.. + 2 MD85	50000181.. + 1 MD85	50000186.. + 2 MD85
ORTRONICS®				
Clarity TechChoice Keystone	5000081.. + 1 MD64	5000086.. + 2 MD64	50000181.. + 1 MD64	50000186.. + 2 MD64
PANDUIT®				
S-MINI-COM	5000081.. + 1 MD69	5000086.. + 2 MD69	50000181.. + 1 MD69	50000186.. + 2 MD69
S-NETKEY	5000081.. + 1 MD67	5000086.. + 2 MD67	50000081.. + 1 MD67	50000086.. + 2 MD67
R&M® (REICHLÉ DE MASSARI®)				
CLASSIC Cat5e (R925371, R925370)	5000081.. + 1 MD54	5000086.. + 2 MD54	50000181.. + 1 MD54	50000186.. + 2 MD54
STAR Cat6 (R302373, R302372)	5000081.. + 1 MD54	5000086.. + 2 MD54	50000181.. + 1 MD54	50000186.. + 2 MD54
ADVANCED Cat6A (R509500, R509504)	5000081.. + 1 MD54	5000086.. + 2 MD54	50000181.. + 1 MD54	50000186.. + 2 MD54
RIT®	5000081.. + 1 MD67	5000086.. + 2 MD67	50000181.. + 1 MD67	50000186.. + 2 MD67
SIEMON®				
Serie MAX Keystone	5000081.. + 1 MD64	5000086.. + 2 MD64	50000181.. + 1 MD64	50000186.. + 2 MD64
SYSTIMAX® (AVAYA®) (ATT®)	5000081.. + 1 MD63	5000086.. + 2 MD63	50000181.. + 1 MD63	50000186.. + 2 MD63

Simon declina toda responsabilidad de cualquier modificación o cambio que realice el fabricante del conector.

COMPATIBILIDAD PLACAS DE VOZ Y DATOS SIMON 500 CIMA

PLACAS INCLINADAS PARA CONECTORES DE OTRAS MARCAS

	Con guardapolvo		Sin guardapolvo	
	1 conector	2 conectores	1 conector	2 conectores
FABRICANTES				
Acabados disponibles	-030 -038			
SIMON	5000085..*	5000089..*	50000185..*	50000189..*
3M® (Volition OCK®: RJ45, K5e, K6)	-	-	50011185..	50011189..
AMP netconnect® (TYCO®)				
Standard 110 SL110 y SL toolless	5000085..*	5000089..*	50000185..*	50000189..*
216000 y 216005	5000085..*	5000089..*	50000185..*	50000189..*
BeldenCDT® (NORDX®)				
Giga Flex MDVO	50013085..*	50013089..*	-	-
Giga Flex Keystone	5000085..*	5000089..*	50000185..*	50000189..*
BRAND-REX® (BICC®)	5000085..*	5000089..*	50000185..*	50000189..*
ERSYS®	5000085..*	5000089..*	50000185..*	50000189..*
GENERAL CABLE®	5000085..*	5000089..*	50000185..*	50000189..*
INFRA +®	50015085..	50015089..	50015185..	50015189..
ITT CANNON®	50016085..	50016089..	-	-
ADC KRONE®				
Serie KM8 keystone	5000085..*	5000089..*	50000185..*	50000189..*
Serie HK keystone	50017085..*	50017089..*	-	-
MOLEX®	5000085..*	5000089..*	50000185..*	50000189..*
NEXANS® (LAN mark®-5 eVo, LAN mark®-6 eVo)	50018085..*	50018089..*	50018185..*	50018189..*
ORTRONICS®				
Clarity TechChoice Keystone	5000085..*	5000089..*	50000185..*	50000189..*
PANDUIT®				
S-MINI-COM	50019085..	50019089..	50019185..	50019189..
S-NETKEY	5000085..*	5000089..*	50000185..*	50000189..*
R&M® (REICHLÉ DE MASSARI®)				
CLASSIC Cat5e (R925371, R925370)	-	-	50020185..*	-
STAR Cat6 (R302373, R302372)	-	-	50020185..*	-
ADVANCED Cat6A Keystone (R509508, R509509)	5000085..*	5000089..*	50000185..*	50000189..*
RIT®	5000085..*	5000089..*	50000185..*	50000189..*
SIEMON®				
Serie MAX Keystone	5000085..*	5000089..*	50000185..*	50000189..*
Serie CT	-	-	50021186-030	50021186-030
SYSTIMAX® (AVAYA®) (ATT®)	5000085..*	5000089..*	50000185..*	50000189..*

... Acabado

* También disponible en **-033**

COMPATIBILIDAD PLACAS K45 DE VOZ Y DATOS SIMON

PLACAS K45 INCLINADAS PARA CONECTORES DE OTRAS MARCAS

	Con guardapolvo		Sin guardapolvo	
	1 conector	2 conectores	1 conector	2 conectores
FABRICANTES				
Acabados disponibles	/9 /14 /8		/9 /14	
SIMON	K80/.. + MD67	KB80/.. + 2 MD67	K080/.. + MD67	KB080/.. + 2 MD67
3M® (Volition OCK®: RJ45, K5e, K6)	-	-	K080/.. + MD45	KB080/.. + 2 MD45
AMP netconnect® (TYCO ELECTRONICS®)				
Standard 110	K80/.. + MD67	-	K080/.. + MD67	-
SL110 y SL toolless	K80/.. + MD67	KB80/.. + 2 MD67	K080/.. + MD67	KB080/.. + 2 MD67
216000 y 216005	K80/.. + MD64	-	K080/.. + MD67	-
BeldenCDT® (NORDX®)				
Giga Flex MDVO	K80/.. + MD68	KB80/.. + 2 MD68	K080/.. + MD68	KB080/.. + 2 MD68
Giga Flex Keystone	K80/.. + MD64	KB80/.. + 2 MD64	K080/.. + MD64	KB080/.. + 2 MD64
BRAND-REX® (BICC®)	K80/.. + MD67	-	K080/.. + MD67	-
CORNING® (SIEMENS®)	K80/.. + MD67	KB80/.. + 2 MD67	K080/.. + MD67	KB080/.. + 2 MD67
ERSYS®	K80/.. + MD64	KB80/.. + 2 MD64	K080/.. + MD64	KB080/.. + 2 MD64
ADC KRONE®				
Serie KM8 keystone	K80/.. + MD64	KB80/.. + 2 MD64	K080/.. + MD64	KB080/.. + 2 MD64
Serie HK keystone	K80/.. + MD64	-	K080/.. + MD64	-
MOLEX®	K80/.. + MD64	KB80/.. + 2 MD64	K080/.. + MD64	KB080/.. + 2 MD64
NEXANS® (LAN mark®-5 EVO, LAN mark®-6 EVO)	K80/.. + MD85	KB80/.. + 2 MD85	K080/.. + MD85	KB080/.. + 2 MD85
ORTRONICS®				
Clarity TechChoice Keystone	K80/.. + MD64	KB80/.. + 2 MD64	K080/.. + MD64	KB080/.. + 2 MD64
PANDUIT®	K80/.. + MD69	KB80/.. + 2 MD69	K080/.. + MD69	KB080/.. + 2 MD69
S-MINI-COM	50019085..	50019089..	50019185..	50019189
S-NETKEY	50000085..	50000089..	50000185..	50000189..
R&M® (REICHLE DE MASSARI®)				
CLASSIC Cat5e (R925371, R925370)	K80/.. + MD54	KB80/.. + 2 MD54	K080/.. + MD54	KB080/.. + 2 MD54
STAR Cat6 (R302373, R302372)	K80/.. + MD54	KB80/.. + 2 MD54	K080/.. + MD54	KB080/.. + 2 MD54
ADVANCED Cat6A (R509500, R509504)	K80/.. + MD54	KB80/.. + 2 MD54	K080/.. + MD54	KB080/.. + 2 MD54
RIT®	K80/.. + MD67	KB80/.. + 2 MD67	K080/.. + MD67	KB080/.. + 2 MD67
SIEMON®				
Serie MAX Keystone	K80/.. + MD64	KB80/.. + 2 MD64	K080/.. + MD64	KB080/.. + 2 MD64
SYSTIMAX® (AVAYA®) (ATT®)	K80/.. + MD63	KB80/.. + 2 MD63	K080/.. + MD63	KB080/.. + 2 MD63

Algunos conectores FTP pueden ser incompatibles en su instalación en placas dobles. Consultar compatibilidad. Simon declina toda responsabilidad de cualquier modificación o cambio que realice el fabricante del conector.

Accesorios



K66
Posicionador 90° K45 para colocar las placas K45 de Voz y Datos en posición vertical en TELEBLOCK K45, Columnas y Minicolumnas K45.

COMPATIBILIDAD PLACAS K45 DE VOZ Y DATOS SIMON

PLACAS K45 PLANAS PARA CONECTORES DE OTRAS MARCAS

	Con guardapolvo			Sin guardapolvo		
	1 conector (medio mecanismo)	1 conector	2 conectores	1 conector (medio mecanismo)	1 conector	2 conectores
FABRICANTES						
Acabados disponibles	/9 /14					
SIMON	KA76/..*	K76/..*	KB76/..*	-	K076/..	KB076/..
3M® (Volition OCK®: RJ45, K5e, K6)				KA045/..	K045/..	KB045/..
AMP netconnect® (TYCO ELECTRONICS®)						
Standard 110	KA76/..	K76/..	-	-	K076/..	-
SL110 y SL toolless	KA76/..	K76/..	KB76/..	-	K076/..	KB076/..
216000 y 216005	KA76/..	K76/..	-	-	K076/..	-
BeldenCDT® (NORDX®)						
Giga Flex MDVO	KA68/..	K68/..	KB68/..	-		
Giga Flex Keystone	KA76/..	K76/..	KB76/..	-	K076/..	KB076/..
BRAND-REX® (BICC®)	KA76/..	K76/..	-	-	K076/..	-
ERSYS®	KA76/..	K76/..	KB76/..	-	K076/..	KB076/..
GENERAL CABLE®	KA76/..	K76/..	KB76/..	-	K076/..	KB076/..
IBM®	-	K87/..	KB87/..	-	K087/..	-
INFRA +®	KA75/..	K75/..	KB75/..	-	K075/..	KB075/..
ITT CANNON®	KA65/..	K65/..	KB65/..	-		
KRONE®						
Serie KM8 keystone	KA76/..	K76/..	KB76/..	-	K076/..	KB076/..
Serie HK keystone	-	K82/..	-	-		
MOLEX®	KA76/..	K76/..	KB76/..	-	K076/..	KB076/..
NEXANS® (LAN mark®-5eVo, LAN mark®-6eVo)	KA85/..	K85/..	KB85/..	-	K085/..	KB085/..
ORTRONICS®						
Clarity TechChoice Keystone	KA76/..	K76/..	KB76/..	K281/..	K076/..	KB076/..
PANDUIT®	KA69/..	K69/..	KB69/..	-	K069/..	KB069/..
S-MINI-COM	50019085..	50019089..	50019185..	50019189	K069/..	KB069/..
S-NETKEY	50000085..	50000089..	50000185..	50000189..		
R&M® (REICHLÉ DE MASSARI®)						
CLASSIC Cat5e (R925371, R925370)	-	-	-	-	K054/..	-
STAR Cat6 (R302373, R302372)	-	-	-	-	K054/..	-
ADVANCED Cat6A Keystone (R509508, R509509)	KA76/..	K76/..*	KB76/..*	-	K076/..	KB076/..
RIT®	KA76/..	K76/..	KB76/..	-	K076/..	KB076/..
SIEMON®						
Serie MAX	-	-	-	-	-	KB72/9
Serie MAX Keystone	KA76/..	K76/..	KB76/..	-	K076/..	KB076/..
SYSTMIX® (AVAYA®) (ATT®)	KA76/..	K76/..	KB76/..	-	K076/..	KB076/..







/.. Acabado * También disponible en /8



Simon **SLIM&DROP**
Sistemas de iluminación

ARQUITECTURAL

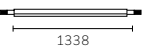
MÓDULOS LUMÍNICOS SUSPENSIÓN / PARED / TECHO

CONTROL	K	LM	W	ARTÍCULO	PVR	PIEZAS	
	OBD	2700	2030	29	91770605-2**	288,00	1
	OBD	3000	2180	29	91770605-3**	288,00	1
	OBD	4000	2310	29	91770605-4**	288,00	1
	DALI one-to-one	2700	2030	30	91770305-2**	343,00	1
	DALI one-to-one	3000	2180	30	91770305-3**	343,00	1
	DALI one-to-one	4000	2310	30	91770305-4**	343,00	1
	OBD	2700	3040	42	91771605-2**	322,00	1
	OBD	3000	3270	42	91771605-3**	322,00	1
	OBD	4000	3460	42	91771605-4**	322,00	1
	DALI one-to-one	2700	3040	43	91771305-2**	389,00	1
	DALI one-to-one	3000	3270	43	91771305-3**	389,00	1
	DALI one-to-one	4000	3460	43	91771305-4**	389,00	1
	OBD	2700	4050	56	91772605-2**	363,00	1
	OBD	3000	4360	56	91772605-3**	363,00	1
	OBD	4000	4620	56	91772605-4**	363,00	1
	DALI one-to-one	2700	4050	57	91772305-2**	441,00	1
	DALI one-to-one	3000	4360	57	91772305-3**	441,00	1
	DALI one-to-one	4000	4620	57	91772305-4**	441,00	1

TRAMOS CIEGOS SUSPENSIÓN / PARED / TECHO

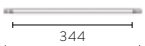
CONTROL	K	LM	W	ARTÍCULO	PVR	PIEZAS	
	Sin continuidad	-	-	-	91899004-0**	90,00	1
	OBD	-	-	-	91899104-0**	128,00	1
	DALI	-	-	-	91899204-0**	141,00	1
	Sin continuidad	-	-	-	91899005-0**	102,00	1
	OBD	-	-	-	91899105-0**	141,00	1
	DALI	-	-	-	91899205-0**	153,00	1
	Sin continuidad	-	-	-	91899006-0**	115,00	1
	OBD	-	-	-	91899106-0**	153,00	1
	DALI	-	-	-	91899206-0**	166,00	1

DROP MINI SUSPENSIÓN / PARED / TECHO

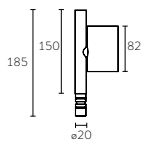
CONTROL	K	LM	W	ARTÍCULO	PVR	PIEZAS
	SPOT 18°					
OBD	2700	1000	13,5	91891611-2**	248,00	1
OBD	3000	1050	13,5	91891611-3**	248,00	1
OBD	4000	1100	13,5	91891611-4**	248,00	1
DALI one-to-one	2700	1000	14,5	91891311-2**	367,00	1
DALI one-to-one	3000	1050	14,5	91891311-3**	367,00	1
DALI one-to-one	4000	1100	14,5	91891311-4**	367,00	1

FLOOD 30°

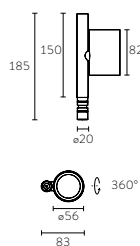

OBD	2700	950	13,5	91891612-2**	248,00	1
OBD	3000	1000	13,5	91891612-3**	248,00	1
OBD	4000	1050	13,5	91891612-4**	248,00	1
DALI one-to-one	2700	950	14,5	91891312-2**	367,00	1
DALI one-to-one	3000	1000	14,5	91891312-3**	367,00	1
DALI one-to-one	4000	1050	14,5	91891312-4**	367,00	1

ACCESORIOS DROP MINI

DESCRIPCIÓN	ARTÍCULO	PVR	PIEZAS
Accesorio Panel de Abeja	92099999-919	20,00	1
Accesorio en Cruz	92099999-929	20,00	1
Accesorio Lente Extensiva	92099992-999	20,00	1

DROP SUSPENSIÓN / PARED / TECHO

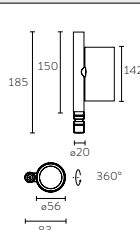

CONTROL	K	LM	W	ARTÍCULO	PVR	PIEZAS
SPOT 18°						
OBD	2700	1350	19	91892611-2**	305,00	1
OBD	3000	1450	19	91892611-3**	305,00	1
OBD	4000	1500	19	91892611-4**	305,00	1
DALI one-to-one	2700	1350	20	91892311-2**	389,00	1
DALI one-to-one	3000	1450	20	91892311-3**	389,00	1
DALI one-to-one	4000	1500	20	91892311-4**	389,00	1

FLOOD 30°

OBD	2700	1300	19	91892612-2**	305,00	1
OBD	3000	1350	19	91892612-3**	305,00	1
OBD	4000	1400	19	91892612-4**	305,00	1
DALI one-to-one	2700	1300	20	91892312-2**	389,00	1
DALI one-to-one	3000	1350	20	91892312-3**	389,00	1
DALI one-to-one	4000	1400	20	91892312-4**	389,00	1

ACCESORIOS DROP

DESCRIPCIÓN	ARTÍCULO	PVR	PIEZAS
Accesorio Panel de Abeja	92099999-919	20,00	1
Accesorio en Cruz	92099999-929	20,00	1
Accesorio Lente Extensiva	92099992-999	20,00	1

SLIM SUSPENDIDA 48V

CONTROL	K	LM	W	ARTÍCULO	PVR	PIEZAS
1,2 m						
OBD	2700	3040	42	91713010-2**	693,00	1
OBD	3000	3270	42	91713010-3**	693,00	1
OBD	4000	4000	42	91713010-4**	693,00	1
DALI	2700	3040	42	91813010-2**	750,00	1
DALI	3000	3270	42	91813010-3**	750,00	1
DALI	4000	4000	42	91813010-4**	750,00	1

CONTROL	K	LM	W	ARTÍCULO	PVR	PIEZAS
1,5 m						
OBD	2700	4050	56	91713110-2**	747,00	1
OBD	3000	4360	56	91713110-3**	747,00	1
OBD	4000	4620	56	91713110-4**	747,00	1
DALI	2700	4050	56	91813110-2**	820,00	1
DALI	3000	4360	56	91813110-3**	820,00	1
DALI	4000	4620	56	91813110-4**	820,00	1

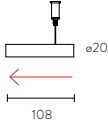
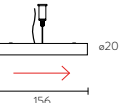
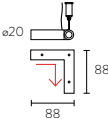
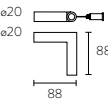
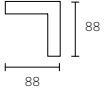
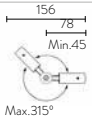

ACCESORIOS PARA SUSPENSIÓN

CONTROL	DESCRIPCIÓN	ARTÍCULO	PVR	
SUSPENSIÓN				
	Sin continuidad Tramo Final	91899007-0**	64,00	1
	OBD Tramo Inicio On Board Dimmer con entrada alimentación	91899307-0**	121,00	1
	DALI Tramo Inicio DALI con entrada alimentación	91899407-0**	134,00	1
	Sin continuidad Tramo Unión	91899001-0**	83,00	1
	OBD Tramo Unión OBD	91899101-0**	92,00	1
	OBD Tramo Unión OBD con entrada alimentación	91899301-0**	154,00	1
	DALI Tramo Unión DALI	91899201-0**	102,00	1
	DALI Tramo Unión DALI con entrada alimentación	91899401-0**	168,00	1
	Sin continuidad Codo 90° Horizontal	91899002-0**	124,00	1
	OBD Codo 90° Horizontal OBD	91899102-0**	139,00	1
	OBD Codo 90° Horizontal OBD con entrada alimentación	91899302-0**	197,00	1
	DALI Codo 90° Horizontal DALI	91899202-0**	153,00	1
	DALI Codo 90° Horizontal DALI con entrada alimentación	91899402-0**	212,00	1
	Sin continuidad Codo 90° Vertical	91899003-0**	124,00	1
	OBD Codo 90° Vertical OBD	91899103-0**	139,00	1
	DALI Codo 90° Vertical DALI	91899203-0**	153,00	1
	Sin continuidad Codo 90° Vertical (Sin Tensor)	91899022-0**	117,00	1
	OBD Codo 90° Vertical OBD (Sin Tensor)	91899122-0**	132,00	1
	DALI Codo 90° Vertical DALI (Sin Tensor)	91899222-0**	146,00	1
	-	91899000-999	11,80	1
	Accesorios suspensión intermedia			
	Sin continuidad Tramo unión con rótula.	91894980-0**	137,00	1
	DALI Tramo unión con rótula	91894982-0**	154,00	1
	Sin continuidad Tapa Final (Sin tensor)	91892007-0**	57,00	1
	OBD Conector Intermedio OBD	91895108-999	58,00	1
	DALI Conector Intermedio DALI	91895208-999	71,00	1

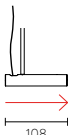
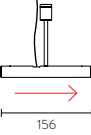
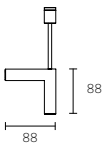
ACCESORIOS PARA SUSPENSIÓN CON VARILLA

CONTROL	DESCRIPCIÓN	ARTÍCULO	PVR	
SUSPENSIÓN CON VARILLA				
	Sin continuidad Tramo Final con Varilla	91899091-0**	99,00	1
	OBD Tramo Inicio OBD con entrada alimentación y Varilla*	91899391-0**	154,00	1
	DALI Tramo Inicio DALI con entrada alimentación y Varilla	91899491-0**	168,00	1
	Sin continuidad Tramo Unión con Varilla	91899092-0**	115,00	1
	OBD Tramo Unión OBD con Varilla	91899192-0**	121,00	1
	OBD Tramo Unión OBD con entrada alimentación y Varilla*	91899392-0**	188,00	1
	DALI Tramo Unión DALI con Varilla	91899292-0**	134,00	1
	DALI Tramo Unión DALI con entrada alimentación y Varilla*	91899492-0**	201,00	1
	Sin continuidad Codo 90° Vertical	91899093-0**	161,00	1
	OBD Codo 90° Vertical OBD	91899193-0**	175,00	1
	DALI Codo 90° Vertical DALI	91899293-0**	190,00	1
	-	91899099-9**	32,00	1
	Varilla 1m			

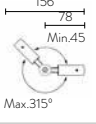
ACCESORIOS PARA SUJECIÓN PARED, TECHO O SUELO

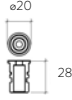
CONTROL	DESCRIPCIÓN	ARTÍCULO	PVR	
PARED / TECHO				
	Sin continuidad Accesorio L	91893012-0**	113,00	1
	OBD Accesorio L OBD con entrada alimentación	91893112-0**	167,00	1
	DALI Accesorio L DALI con entrada alimentación	91893212-0**	182,00	1
	Sin continuidad Accesorio de unión a pared Rótula	91894990-0**	148,00	1
	DALI Accesorio de unión DALI a pared Rótula	91894992-0**	170,00	1
	-	91893009-0**	103,00	1
	Accesorio Pared para driver			
	-	91893010-0**	87,00	1
	Accesorio Pared para regleta			
	-	91893011-0**	47,00	1
	Accesorio Pared para sujeción			
				

FLORONES Y EQUIPOS DE ALIMENTACIÓN

CONTROL	DESCRIPCIÓN	W	ARTÍCULO	PVR	PIEZAS
SUPERFICIE					
72 W		47			
On-Off / DALI	Florón superficie con equipo 72W	64	91791901-9**	237,00	1
On-Off / DALI	Florón superficie con equipo 100W	90	91791902-9**	292,00	1
On-Off / DALI	Florón superficie con equipo 240W	216	91791903-9**	349,00	1

CONTROL	DESCRIPCIÓN	W	ARTÍCULO	PVR	PIEZAS
TRIMLESS SUSPENSIÓN					
Sin Contin.	Florón suspendido X-Less	-	91899018-0**	77,00	1

CONTROL	DESCRIPCIÓN	W	ARTÍCULO	PVR	PIEZAS
TRIMLESS TECHO					
OBD	Florón X-Less con Rótula OBD	-	91894115-0**	246,00	1
DALI	Florón X-Less con Rótula DALI	-	91894215-0**	255,00	1

CONTROL	DESCRIPCIÓN	W	ARTÍCULO	PVR	PIEZAS
EQUIPOS DE ALIMENTACIÓN					
On-Off / DALI	Equipo 72W	64	91793901-999	114,00	1
On-Off / DALI	Equipo 100W	90	91793902-999	120,00	1
On-Off / DALI	Equipo 240W	216	91793903-999	133,00	1

X-LESS - ACCESORIOS

DESCRIPCIÓN	ARTÍCULO	PVR	PIEZAS
Accesorio X-trimless	99921109-199	27,00	1

CAJA REGISTRO

DESCRIPCIÓN	ARTÍCULO	PVR	PIEZAS
Caja registro X-Less Blanca	99981000-900	61,00	1
Caja registro X-Less Imprimable	99981000-977	61,00	1











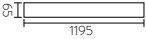















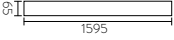







860

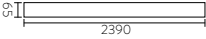



ESTRUCTURA PERFIL

DESCRIPCIÓN	ARTÍCULO	PVR	PIEZAS
Luminaria Lineal 860.21 perfil 1200 empotrado	860210**-109	50,00	1
Luminaria Lineal 860.22 perfil 1600 empotrado	860220**-109	65,00	1
Luminaria Lineal 860.23 perfil 2400 empotrado	860230**-109	96,00	1
Luminaria Lineal 860.41 perfil 1200 superficie/suspendido	860410**-109	58,00	1
Luminaria Lineal 860.42 perfil 1600 superficie/suspendido	860420**-109	50,00	1
Luminaria Lineal 860.43 perfil 2400 superficie/suspendido	860430**-109	65,00	1
Accesorio corner perfil empotrado	860243**-309	96,00	1
Accesorio corner perfil superficie/suspendido	860443**-309	58,00	1
Perfil 860 1200 3000K UP&DOWN	860462**-393	149,00	1
Perfil 860 1200 4000K UP&DOWN	860462**-394	140,00	1
Perfil 860 1600 3000K UP&DOWN	860466**-393	290,00	1
Perfil 860 1600 4000K UP&DOWN	860466**-394	290,00	1
Perfil 860 2400 3000K Blanco UP&DOWN	86044230-393	385,00	1
Perfil 860 2400 4000K Blanco UP&DOWN	86044230-394	385,00	1
Perfil 860 2400 3000K Negro UP&DOWN	86044238-393	385,00	1
Perfil 860 2400 4000K Negro UP&DOWN	86044238-394	385,00	1
Accesorio corner Low UGR perfil superficie/suspendido	860044**-209	97,00	1
Accesorio corner Low UGR perfil empotrado	860244**-209	97,00	1
Accesorio en T Ciego empotrado	860245**-209	95,00	1
Accesorio en X Ciego empotrado	860246**-209	95,00	1
Accesorio en T Ciego superficie	860478**-039	95,00	1
Accesorio en X Ciego superficie	860479**-039	95,00	1

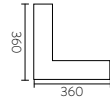
MÓDULOS LUMÍNICOS

	Luminaria Lineal modulo 860 1200 3000 K	 86001300-383	163,46	1
	Luminaria Lineal modulo 860 1200 4000 K	 86001300-384	163,46	1
	Luminaria Lineal modulo 860 1200 3000K CRI90	 86001300-393	164,00	1
	Luminaria Lineal modulo 860 1200 4000K CRI90	 86001300-394	164,00	1
	Luminaria Lineal modulo 860 1200 TW CRI90	 86001300-399	240,00	1
	Luminaria Lineal modulo 860 Low UGR 1200 3000 K	 86001300-583	259,61	1
	Luminaria Lineal modulo 860 Low UGR 1200 4000 K	 86001300-584	259,61	1
	Luminaria Lineal modulo 860 Low UGR 1200 3000K CRI90	 86001300-593	260,00	1
	Luminaria Lineal modulo 860 Low UGR 1200 4000K CRI90	 86001300-594	260,00	1
	Luminaria Lineal modulo 860 Low UGR 1200 TW CRI90	 86001300-599	350,00	1
	Luminaria Lineal modulo 860 1600 3000 K	 86002300-383	182,69	1
	Luminaria Lineal modulo 860 1600 4000 K	 86002300-384	182,69	1
	Luminaria Lineal modulo 860 1600 3000K CRI90	 86002300-393	183,00	1
	Luminaria Lineal modulo 860 1600 4000K CRI90	 86002300-394	183,00	1
	Luminaria Lineal modulo 860 1600 TW CRI90	 86002300-399	275,00	1
	Luminaria Lineal modulo 860 Low UGR 1600 3000 K	 86002300-583	276,92	1
	Luminaria Lineal modulo 860 Low UGR 1600 4000 K	 86002300-584	276,92	1
	Luminaria Lineal modulo 860 Low UGR 1600 3000K CRI90	 86002300-593	277,00	1
	Luminaria Lineal modulo 860 Low UGR 1600 4000K CRI90	 86002300-594	277,00	1
	Luminaria Lineal modulo 860 Low UGR 1600 TW CRI90	 86002300-599	380,00	1
	Luminaria Lineal modulo 860 2400 3000 K	 86003300-383	240,38	1
	Luminaria Lineal modulo 860 2400 4000 K	 86003300-384	240,38	1
	Luminaria Lineal modulo 860 2400 3000K CRI90	 86003300-393	241,00	1
	Luminaria Lineal modulo 860 2400 4000K CRI90	 86003300-394	241,00	1
	Luminaria Lineal modulo 860 2400 TW CRI90	 86003300-399	370,00	1
	Luminaria Lineal modulo 860 Low UGR 2400 3000 K	 86003300-583	337,50	1
	Luminaria Lineal modulo 860 Low UGR 2400 4000 K	 86003300-584	337,50	1
	Luminaria Lineal modulo 860 Low UGR 2400 3000K CRI90	 86003300-593	338,00	1
	Luminaria Lineal modulo 860 Low UGR 2400 4000K CRI90	 86003300-594	338,00	1
	Luminaria Lineal modulo 860 Low UGR 2400 TW CRI90	 86003300-599	470,00	1







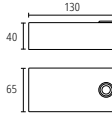
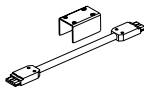
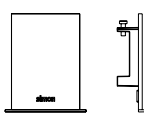
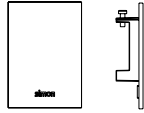
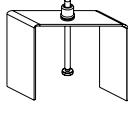
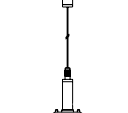

Accesorio corner light modulo 3000K	 86004300-183	125,00	1
Accesorio corner light modulo 4000K	 86004300-184	125,00	1
Accesorio corner light modulo 3000K CRI90	 86004300-193	125,00	1
Accesorio corner light modulo 4000K CRI90	 86004300-194	125,00	1

DIFUSORES

Microprismatico corner	86099900-510	29,00	1
Opal corner	86099900-520	12,60	1
Microprismatico 1200 mm	86099900-612	87,00	5
Microprismatico 1600 mm	86099900-616	116,00	5
Microprismatico 2400 mm	86099900-624	174,00	5
Opal Enrollable 10 m	86099900-700	51,00	1
Opal1200 mm	86099900-712	39,00	5
Opal1600 mm	86099900-716	52,00	5
Opal2400 mm	86099900-724	78,00	5

ACCESORIOS INSTALACIÓN

Cable de alimentación 5P 4m	86097905-039	32,00	1
 Accesorio florón	860969**-039	35,00	1
 Conector estructural luminaria lineal	86097900-039	16,00	1
 Tapa final empotrado	860259**-039	22,00	2
 Tapa final suspendido	860459**-039	22,00	2
 Accesorio empotra	86098700-039	9,60	2
 Accesorio empotrar	86098900-039	14,50	3
 Kit de suspensión 4 m	860487**-039	14,50	2
 Kit de suspensión 4 m	860489**-039	22,00	3
 Accesorio varilla 1 m	860987**-039	9,60	2
 Accesorio varilla 1 m	860999**-039	41,00	3
 Extensión varilla 0.5m	860988**-039	11,50	1

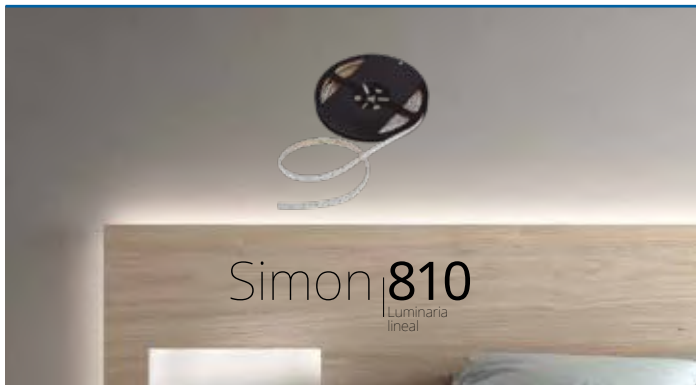

810 ESSENTIALS

K	IP	LED/M	LM	W	WTOTAL	LONGITUD	ARTÍCULO	PVR	PIEZAS
2700 CRI>80	20	60	590	4,8	24	5m	81023000-982	34,00	1
4000 CRI>80	20	60	600	4,8	24	5m	81023000-984	34,00	1
3000 CRI>80	20	60	590	4,8	24	5m	81023000-983	34,00	1
2700 CRI>80	20	60	590	4,8	96	20m	81023020-982	131,00	1
3000 CRI>80	20	60	590	4,8	96	20m	81023020-983	131,00	1
4000 CRI>80	20	60	600	4,8	96	20m	81023020-984	131,00	1
2700 CRI>80	65	60	590	4,8	24	5m	81023100-982	45,00	1
3000 CRI>80	65	60	590	4,8	24	5m	81023100-983	45,00	1
4000 CRI>80	65	60	600	4,8	24	5m	81023100-984	45,00	1
2700 CRI>80	20	60	1181	9,6	48	5m	81025000-982	45,00	1
4000 CRI>80	20	60	1200	9,6	48	5m	81025000-984	45,00	1
3000 CRI>80	20	60	1181	9,6	48	5m	81025000-983	45,00	1
2700 CRI>80	20	60	1181	9,6	192	20m	81025020-982	176,00	1
3000 CRI>80	20	60	1181	9,6	192	20m	81025020-983	176,00	1
4000 CRI>80	20	60	1200	9,6	192	20m	81025020-984	176,00	1
2700 CRI>80	65	60	1181	9,6	48	5m	81025100-982	62,00	1
3000 CRI>80	65	60	1181	9,6	48	5m	81025100-983	62,00	1
4000 CRI>80	65	60	1200	9,6	48	5m	81025100-984	62,00	1
2700 CRI>80	20	60	1771	14,4	72	5m	81026000-982	56,50	1
3000 CRI>80	20	60	1771	14,4	72	5m	81026000-983	56,50	1
4000 CRI>80	20	60	1800	14,4	72	5m	81026000-984	56,50	1
2700 CRI>80	20	60	1771	14,4	288	20m	81026020-982	221,00	1
3000 CRI>80	20	60	1771	14,4	288	20m	81026020-983	221,00	1
4000 CRI>80	20	60	1800	14,4	288	20m	81026020-984	221,00	1
2700 CRI>80	65	60	1771	14,4	72	5m	81026100-982	70,50	1
3000 CRI>80	65	60	1771	14,4	72	5m	81026100-983	70,50	1
4000 CRI>80	65	60	1800	14,4	72	5m	81026100-984	70,50	1
2700 CRI>80	20	120	2362	19,2	96	5m	81028000-982	90,50	1
3000 CRI>80	20	120	2362	19,2	96	5m	81028000-983	90,50	1
4000 CRI>80	20	120	2400	19,2	96	5m	81028000-984	90,50	1
2700 CRI>80	20	120	2362	19,2	384	20m	81028020-982	356,50	1
3000 CRI>80	20	120	2362	19,2	384	20m	81028020-983	356,50	1
4000 CRI>80	20	120	2400	19,2	384	20m	81028020-984	356,50	1
2700 CRI>80	65	120	2362	19,2	96	5m	81028100-982	104,50	1
3000 CRI>80	65	120	2362	19,2	96	5m	81028100-983	104,50	1
4000 CRI>80	65	120	2400	19,2	96	5m	81028100-984	104,50	1

ESSENTIAL PRO

2700 CRI>90 R9>80	20	60	490	4,8	24	5m	81033000-992	51,00	1
3000 CRI>90 R9>80	20	60	500	4,8	24	5m	81033000-993	51,00	1
4000 CRI>90 R9>80	20	60	510	4,8	24	5m	81033000-994	51,00	1
6500 CRI>90 R9>80	20	60	530	4,8	24	5m	81033000-996	51,00	1
2700 CRI>90 R9>80	65	60	490	4,8	24	5m	81033100-992	65,00	1

3000 CRI>90 R9>80	65	60	500	4,8	24	5m	81033100-993	65,00	1
4000 CRI>90 R9>80	65	60	510	4,8	24	5m	81033100-994	65,00	1
6500 CRI>90 R9>80	65	60	530	4,8	24	5m	81033100-996	65,00	1
2700 CRI>90 R9>80	20	120	970	9,6	48	5m	81035000-992	90,50	1
3000 CRI>90 R9>80	20	120	980	9,6	48	5m	81035000-993	90,50	1
4000 CRI>90 R9>80	20	120	1030	9,6	48	5m	81035000-994	90,50	1
6500 CRI>90 R9>80	20	120	1090	9,6	48	5m	81035000-996	90,50	1
2700 CRI>90 R9>80	65	120	950	9,6	48	5m	81035100-992	104,50	1
3000 CRI>90 R9>80	65	120	960	9,6	48	5m	81035100-993	104,50	1
4000 CRI>90 R9>80	65	120	1010	9,6	48	5m	81035100-994	104,50	1
6500 CRI>90 R9>80	65	120	1070	9,6	48	5m	81035100-996	104,50	1
2700 CRI>90 R9>80	20	120	1440	14,4	72	5m	81036000-992	104,00	1
3000 CRI>90 R9>80	20	120	1480	14,4	72	5m	81036000-993	104,00	1
4000 CRI>90 R9>80	20	120	1580	14,4	72	5m	81036000-994	104,00	1
6500 CRI>90 R9>80	20	120	1620	14,4	72	5m	81036000-996	104,00	1
2700 CRI>90 R9>80	65	120	1420	14,4	72	5m	81036100-992	118,50	1
3000 CRI>90 R9>80	65	120	1460	14,4	72	5m	81036100-993	118,50	1
4000 CRI>90 R9>80	65	120	1560	14,4	72	5m	81036100-994	118,50	1
6500 CRI>90 R9>80	65	120	1600	14,4	72	5m	81036100-996	118,50	1
2700 CRI>90 R9>80	20	120	1880	19,2	96	5m	81038000-992	127,50	1
3000 CRI>90 R9>80	20	120	1920	19,2	96	5m	81038000-993	127,50	1
4000 CRI>90 R9>80	20	120	2050	19,2	96	5m	81038000-994	127,50	1
6500 CRI>90 R9>80	20	120	2180	19,2	96	5m	81038000-996	127,50	1
2700 CRI>90 R9>80	65	120	1790	19,2	96	5m	81038100-992	143,50	1
3000 CRI>90 R9>80	65	120	1830	19,2	96	5m	81038100-993	143,50	1
4000 CRI>90 R9>80	65	120	1960	19,2	96	5m	81038100-994	143,50	1
6500 CRI>90 R9>80	65	120	2090	19,2	96	5m	81038100-996	143,50	1

ALTA EFICIENCIA

2700 CRI>80	20	128	920	7,2	36	5m	81034000-982	119,50	1
3000 CRI>80	20	128	960	7,2	36	5m	81034000-983	119,50	1
4000 CRI>80	20	128	1040	7,2	36	5m	81034000-984	119,50	1
6500 CRI>80	20	128	1080	7,2	36	5m	81034000-986	119,50	1
2700 CRI>80	65	128	840	7,2	36	5m	81034100-982	134,50	1
3000 CRI>80	65	128	880	7,2	36	5m	81034100-983	134,50	1
4000 CRI>80	65	128	960	7,2	36	5m	81034100-984	134,50	1
6500 CRI>80	65	128	1000	7,2	36	5m	81034100-986	134,50	1
2700 CRI>80	20	240	1800	14	70	5m	81062000-982	179,50	1
3000 CRI>80	20	240	1880	14	70	5m	81062000-983	179,50	1
4000 CRI>80	20	240	1980	14	70	5m	81062000-984	179,50	1
6500 CRI>80	20	240	2060	14	70	5m	81062000-986	179,50	1
2700 CRI>80	65	240	1740	14	70	5m	81062100-982	204,50	1
3000 CRI>80	65	240	1820	14	70	5m	81062100-983	204,50	1
4000 CRI>80	65	240	1920	14	70	5m	81062100-984	204,50	1
6500 CRI>80	65	240	2000	14	70	5m	81062100-986	204,50	1

EST.CORRIENTE

2700 CRI>80	20	98	1600	16	80	5m	81086000-982	124,00	1
3000 CRI>80	20	98	1600	16	80	5m	81086000-983	124,00	1
4000 CRI>80	20	98	1600	16	80	5m	81086000-984	124,00	1
2700 CRI>80	65	98	1600	16	80	5m	81086100-982	140,00	1
3000 CRI>80	65	98	1600	16	80	5m	81086100-983	140,00	1
4000 CRI>80	65	98	1600	16	80	5m	81086100-984	140,00	1

CONTORNO

2700 CRI>80	20	60	1180	14,4	72	5m	81042000-982	127,00	1
3000 CRI>80	20	60	1200	14,4	72	5m	81042000-983	127,00	1
4000 CRI>80	20	60	1220	14,4	72	5m	81042000-984	127,00	1
6500 CRI>80	20	60	1250	14,4	72	5m	81042000-986	127,00	1

ANCHO 5MM

2700 CRI>80	20	120	1320	14,4	72	5m	81052000-982	160,00	1
3000 CRI>80	20	120	1340	14,4	72	5m	81052000-983	160,00	1
4000 CRI>80	20	120	1360	14,4	72	5m	81052000-984	160,00	1
6500 CRI>80	20	120	1430	14,4	72	5m	81052000-986	160,00	1

RGB+2700K

RGB	20	60	480	14,4	72	5m	81036000-900	136,50	1
RGB	65	60	450	14,4	72	5m	81036100-900	157,00	1
RGB+2700	20	60	975	19,2	96	5m	81037000-902	160,50	1
RGB+2700	65	60	933	19,2	96	5m	81037100-902	177,50	1

BIODINÁMICA

2700-6000	20	60	940	12	60	5m	81036000-800	141,00	1
2700-6000	65	60	920	12	60	5m	81036100-800	155,00	1

ALIMENTACIÓN

2000 CRI>92	20	120	666	7,7	38,5	5m	81034000-910	130,50	1
2300 CRI>92	20	120	725	7,7	38,5	5m	81034000-920	130,50	1
6500 CRI>92	20	120	724	7,7	38,5	5m	81034000-940	130,50	1

PERFILERÍA DE SUPERFICIE

PERFILERÍA CON CANAL AUXILIAR PARA CABLEADO

DESCRIPCIÓN	ACABADO	ARTÍCULO	PVR	PIEZAS
Perfilería cableado para LedFlex	Aluminio	81202133-039	25,00	1
Difusor transparente perf. Empotrar	Transparente	81210012-039	9,80	1
Difusor opal perfilería empotrar	Opal	81210010-039	9,80	1
Tapa perfilería cableado	-	81222100-039	1,20	1
Clip montaje perfilería cableado	-	81272100-139	1,20	1
Grapa con pinza para empotrar	-	81270000-239	6,80	1

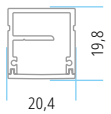

PERFILERÍA DE SUPERFICIE

Perfilería superficie para LedFlex	Aluminio	81200133-039	18,50	1
Perfilería superficie LedFlex Blanco	Blanco	81200130-039	22,50	1
Perfilería superficie para LedFlex Negro	Negro	81200138-039	20,50	1
Difusor opal perfilería superficie	Opal	81210110-039	9,00	1
Difusor transparente perfilería múltiple	Transparente	81210112-039	9,00	1
Tapa final perfilería superficie	Gris	81220100-039	1,20	1
Tapa inicio perfilería superficie	Gris	81230100-039	1,20	1
Tapa final Perfilería superficie Blanco	Blanco	81220130-039	1,30	1
Tapa inicio Perfilería superficie Blanco	Blanco	81230130-039	1,30	1
Tapa final Perfilería superficie Negro	Negro	81220138-039	1,30	1
Tapa inicio Perfilería superficie Negro	Negro	81230138-039	1,30	1
Clip perfilería superficie	-	81270100-139	1,20	1
Grapa con pinza para empotrar	-	81270000-239	6,80	1

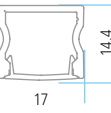

PERFILERÍA DE SUPERFICIE SLIM

Perfilería superficie slim para LedFlex	Aluminio	81201933-039	11,50	1
Perfilería superficie slim LedFlex Blanco	Blanco	81201930-039	15,50	1
Perfilería superficie slim LedFlex Negro	Negro	81201938-039	12,50	1
Difusor transparente perfilería múltiple	Transparente	81210112-039	9,00	1
Difusor opal perfilería slim	Opal	81211910-039	9,00	1
Tapa final perfilería superficie slim	Gris	81221933-039	1,20	1
Tapa inicio perfilería superficie slim	Gris	81231933-039	1,20	1
Tapa final perf. superficie slim Blanco	Blanco	81221930-039	1,30	1
Tapa inicio perf. superficie slim Blanco	Blanco	81231930-039	1,30	1
Tapa final perf. superficie slim Negro	Negro	81221938-039	1,30	1
Tapa inicio perf. superficie slim Negro	Negro	81231938-039	1,30	1
Grapa con pinza para empotrar	-	81270000-239	6,80	1
Clips perfilería superficie	-	81270100-139	1,20	1

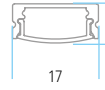

PERFILERÍA DE SUPERFICIE MINI

Perfilería superficie mini para LedFlex	Aluminio	81201733-039	9,10	1
Perfilería superficie mini LedFlex Negro	Negro	81201738-039	12,00	1
Tapa final perf. superficie mini	Gris	81221733-039	1,30	1
Tapa inicio perf. superficie mini	Gris	81231733-039	1,30	1
Tapa final perf. superficie mini Negro	Negro	81221738-039	1,20	1
Tapa inicio perf. superficie mini Negro	Negro	81231738-039	1,20	1
Clip montaje perfilería mini	-	81271700-139	1,20	1
Difusor opal perfilería mini	-	81211610-039	7,50	1

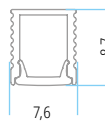

PERFILERÍA DE SUPERFICIE

PERFILERÍA DE EMPOTRAR

Perfilería empotrar para LedFlex	Aluminio	81200033-039	19,00	1
Perfilería empotrar para LedFlex Negro	Negro	81200038-039	24,00	1
Difusor transparente perf. Empotrar	Transparente	81210012-039	9,80	1
Difusor opal perfilería empotrar	Opal	81210010-039	9,80	1
Tapa final perfilería empotrar	Aluminio	81220000-039	1,20	1
Tapa inicio perfilería empotrar	Aluminio	81230000-039	1,20	1
Tapa final perfilería empotrar negro	Negro	81220038-039	1,20	1
Tapa inicio perfilería empotrar negro	-	81230038-039	1,20	1

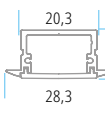

PERFILERÍA DE EMPOTRAR SLIM

	Perfilería empotrar slim para LedFlex	Aluminio	81201833-039	11,50	1
	Perfilería empotrar slim LedFlex Blanco	Blanco	81201830-039	15,50	1
	Perfilería empotrar slim LedFlex Negro	Negro	81201838-039	12,50	1
	Difusor transparente perfilera múltiple	Transparente	81210112-039	9,00	1
	Difusor opal perfilera slim	Opal	81211910-039	9,00	1
	Tapa final perfilera empotrar slim	Gris	81221833-039	1,20	1
	Tapa inicio perfilera empotrar slim	Gris	81231833-039	1,20	1
	Tapa final perf. empotrar slim Blanco	Blanco	81221830-040	1,30	1
	Tapa inicio perf. empotrar slim Blanco	Blanco	81231830-040	1,30	1
	Tapa final perf. empotrar slim Negro	Negro	81221838-041	1,30	1
	Tapa inicio perf. empotrar slim Negro	Negro	81231838-041	1,30	1

PERFILERÍA DE EMPOTRAR MINI

	Perfilería empotrar mini para LedFlex	Aluminio	81201633-039	9,40	1
	Perfilería empotrar mini LedFlex Negro	Negro	81201638-039	13,50	1
	Tapa final perf. empotrar mini	Gris	81221633-039	1,30	1
	Tapa inicio perf. empotrar mini	Gris	81231633-039	1,30	1
	Tapa final perf. empotrar mini Negro	Negro	81221638-039	1,30	1
	Tapa inicio perf. empotrar mini Negro	Negro	81231638-039	1,30	1
	Clip montaje perfilera mini	-	81271700-139	1,20	1
	Difusor opal perfilera mini	Opal	81211610-039	7,50	1

PERFILERÍA ANGULAR

PERFILERÍA ANGULAR ENRASADO

	Perfilería angular para LedFlex	Aluminio	81200233-039	27,50	1
	Difusor opal perf. angular y colgante	Opal	81210210-039	8,90	1
	Difusor lente perfilera angular LedFlex	-	81210213-039	11,00	1
	Tapa final perfilera angular	Gris	81220200-039	1,20	1
	Tapa inicio perfilera angular	Gris	81230200-039	1,20	1
	Clip montaje perfilera angular	-	81270200-139	1,20	1

PERFILERÍA ANGULAR REDONDA

	Perfilería angular redonda para LedFlex	Aluminio	81200633-039	16,00	1
	Difusor opal perfilera angular redonda	Opal	81210611-039	9,00	1
	Tapa final perfilera angular redonda	Gris	81220600-039	1,20	1
	Tapa inicio perfilera angular redonda	Gris	81230600-039	1,20	1
	Clip montaje perfilera angular redonda	-	81270600-139	1,20	1

PERFILERÍA ARQUITECTÓNICA

PERFILERÍA INTEGRADA ESCAYOLA

	Perfilería escayola para LedFlex	Aluminio	81202233-039	34,00	1
	Difusor translúcido perfilera escayola	Translúcido	81212210-039	12,50	1
	Tapa final perfilera escayola	Gris	81222200-039	2,00	1
	Tapa inicio perfilera escayola	Gris	81232200-039	2,00	1

PERFILERÍA INTEGRADA AZULEJO

	Perfilería arquitectural para LedFlex	Aluminio	81202033-039	37,00	1
	Tapa final perfilera Arquitectural	Gris	81222000-039	1,20	1
	Tapa inicio perfilera Arquitectural	Gris	81232000-039	1,20	1
	Difusor transparente perfilera múltiple	Transparente	81210112-039	9,00	1
	Difusor opal perfilera superficie	Opal	81210110-039	9,00	1

PERFILERÍA INTEGRADA ZÓCALO

	Perfilería Zócalo para LedFlex	Aluminio	81200933-039	52,50	1
	Perfilería Zócalo para LedFlex Blanco	Blanco	81200930-039	56,50	1
	Difusor opal perfilera Zócalo	Opal	81210910-039	7,50	1
	Tapas perfilera Zócalo kit	Gris	81220900-039	2,50	1
	Tapas perfilera Zócalo Blanco kit	Blanco	81220930-039	2,90	1

PERFILERÍA FLEXIBLE

PERFILERÍA FLEXIBLE HORIZONTAL

	Perfilería flexible horizontal LedFlex	Blanco	81208030-039	37,50	1
	Tapa final perf. flexible horiz. LedFlex	Gris	81238000-039	2,10	1
	Tapa inicio perf. flexible horiz. LedFlex	Gris	81228000-039	2,10	1
	Clip montaje perfilera flexible horiz.	-	81278030-139	1,20	1

PERFILERÍA FLEXIBLE VERTICAL

	Perfilería flexible vertical LedFlex	Blanco	81208060-039	42,50	1
	Tapa final perf. flexible vert. LedFlex	Gris	81228020-039	2,10	1
	Tapa inicio perf. flexible vert. LedFlex	Gris	81238020-039	2,10	1
	Clip montaje perfilera flexible vertical	-	81278060-139	1,70	1

PERFILERÍA SUSPENDIDA

PERFILERÍA CILÍNDRICA OPAL

	Perfilería cilíndrica opal para LedFlex	Opal	N 81202310-039	51,50	1
	Tapa perfilera cilíndrica para LedFlex	Opal	N 81222300-039	8,30	1
	Placa interna perfilera cilíndrica	Aluminio	N 81272300-039	7,50	1
	Clip montaje perfilera cilíndrica	-	N 81272300-139	2,30	1
	Acc. Susp. perfilera cilíndrica Blanco	-	N 81272330-339	19,50	1
	Acc. Susp. perfilera cilíndrica Negro	-	N 81272338-339	19,50	1

PERFILERÍA SUSPENDIDA CUADRADA

	Perfilería suspendida para LedFlex	Aluminio	N 81200833-039	60,00	1
	Perfilería suspendida LedFlex Blanco	Blanco	N 81200830-039	64,50	1
	Perfilería suspendida para LedFlex Negro	Negro	N 81200838-039	64,50	1
	Difusor translúcido perf. suspendida	Translúcido	N 81210811-039	11,50	1
	Tapa perfilera suspendida	Gris	N 81220800-039	2,00	1
	Tapa perfilera suspendida Blanco	Blanco	N 81220830-039	2,30	1
	Tapa perfilera suspendida Negro	Negro	N 81220838-039	2,30	1
	Accesorio perfilera suspendida	-	N 81270800-339	14,50	1

PERFILERÍA SUSPENDIDA REDONDA

	Perfilería colgante redonda para LedFlex	Aluminio	N 81200533-039	27,00	1
	Perfilería colgante redonda LedFlex Negro	Negro	N 81200538-039	29,00	1
	Tapa final perfilera colgante	Gris	N 81220500-039	1,60	1
	Tapa inicio perfilera colgante	Gris	N 81230500-039	1,60	1
	Tapa final perfilera colgante negro	Negro	N 81220538-039	1,70	1
	Tapa inicio perfilera colgante negro	Negro	N 81230538-039	1,70	1
	Difusor opal perf. angular y colgante	Opal	N 81210210-039	8,90	1
	Soporte lateral perfilera colgante	-	N 81270500-539	6,60	1
	Soporte central perfilera colgante	-	N 81270500-639	8,30	1

EMPOTRABLES EN SUELOS

PERFILERÍA PISABLE

	Perfilería pisable para LedFlex	Aluminio	N 81201533-039	22,50	1
	Tapa perfilera pisable para LedFlex	Gris	N 81221500-039	2,70	1
	Difusor opal perfilera pisable LedFlex	Opal	N 81211510-039	13,80	1
	Resina epoxi perfilera pisable LedFlex	-	N 81271500-039	7,60	1

EQUIPOS: FUENTES DE TENSIÓN

DESCRIPCIÓN	DIMENSIONES	IP	CONTROL	ARTÍCULO	PVR	PIEZAS
18W/24V	115 x 45 x 21	20	On-OFF	81090024-139	16,00	1
40W/24V	166 x 52 x 24	20	On-OFF	81090035-139	29,50	1
60W/24V	184 x 61 x 32	20	On-OFF	81090060-139	36,00	1
75W/24V	184 x 61 x 32	20	On-OFF	81090070-139	56,50	1
150W/24V	210 x 67 x 34	20	On-OFF	81090150-139	96,00	1
240W/24V	249 x 70 x 40	67	On-OFF	81090250-139	130,00	1
75W/24V HE	180 x 63 x 35,5	67	On-OFF	81095300-039	73,50	1
150W/24V HE	219 x 63 x 35,5	67	On-OFF	81095400-039	124,00	1
240W/24V HE	244 x 71 x 37,5	67	On-OFF	81095500-039	158,00	1
25W/24V 1-10V HE	110 x 75 x 22	20	1-10V	81091025-039	60,00	1
65W/24V 1-10V HE	130 x 75 x 25	20	1-10V	81091065-039	74,50	1
75W/24V 1-10V HE	180 x 63 x 35,5	67	1-10V	81091075-039	84,50	1
150W/24V 1-10V HE	219 x 63 x 35,5	67	1-10V	81091150-039	135,50	1
240W/24V 1-10V HE	244 x 71 x 37,5	67	1-10V	81091240-039	169,00	1
75W/24V DALI HE	180 x 63 x 35,5	67	DALI	81093060-039	108,50	1
150W/24V DALI HE	219 x 63 x 35,5	67	DALI	81093150-039	169,00	1



ÓPTICAS (°)	K	LM	W	ARTÍCULO	PVR	PIEZAS
1-10V PUSH&DIM*						
Flood 36°	2700	700	9	91551002-2**	172,00	1
Flood 36°	3000	700	9	91551002-3**	172,00	1
Flood 36°	4000	900	9	91551002-4**	172,00	1
Wide Flood 60°	2700	600	9	91551003-2**	172,00	1
Wide Flood 60°	3000	600	9	91551003-3**	172,00	1
Wide Flood 60°	4000	750	9	91551003-4**	172,00	1
DALI						
Flood 36°	2700	700	9	91552002-2**	199,00	1
Flood 36°	3000	700	9	91552002-3**	199,00	1
Flood 36°	4000	900	9	91552002-4**	199,00	1
Wide Flood 60°	2700	600	9	91552003-2**	199,00	1
Wide Flood 60°	3000	600	9	91552003-3**	199,00	1
Wide Flood 60°	4000	750	9	91552003-4**	199,00	1

ARCH TRIMLESS REDONDO / TRIMLESS

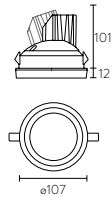

ÓPTICAS (°)	K	LM	W	ARTÍCULO	PVR	PIEZAS
1-10V PUSH&DIM*						
Flood 36°	2700	700	9	91563002-2**	139,00	1
Flood 36°	3000	700	9	91563002-3**	139,00	1
Flood 36°	4000	900	9	91563002-4**	139,00	1
Wide Flood 60°	2700	600	9	91563003-2**	139,00	1
Wide Flood 60°	3000	600	9	91563003-3**	139,00	1
Wide Flood 60°	4000	750	9	91563003-4**	139,00	1

X-LESS SISTEMA TRIMLESS PATENTADO / TRIMLESS

DESCRIPCIÓN	ARTÍCULO	PVR	PIEZAS
1-10V PUSH&DIM*			
X-Less 1 Equipo incluido	91591019-999	67,00	1
DALI			
X-Less 1 Equipo incluido	91592019-999	80,00	1
ACCESORIO			
X-Less accesorio unión (2 uni)	91592019-000	6,60	1



Simon HOLE
Downlight

ARQUITECTURAL

HOLE 25 RECESSED

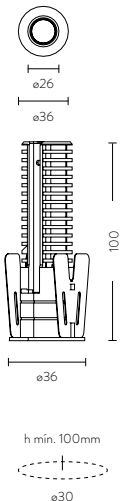

ÓPTICAS (°)	K	LM	W	ARTÍCULO	PVR	PIEZAS
EMPOTRAR						
Spot 15°	2700 CRI90	254	3,5	91410911-2**	108,00	1
Spot 15°	3000 CRI90	266	3,5	91410911-3**	108,00	1
Spot 15°	4000 CRI90	299	3,5	91410911-4**	108,00	1
Flood 35°	2700 CRI90	215	3,5	91410912-2**	108,00	1
Flood 35°	3000 CRI90	222	3,5	91410912-3**	108,00	1
Flood 35°	4000 CRI90	249	3,5	91410912-4**	108,00	1
EQUIPOS						
DESCRIPCIÓN	ARTÍCULO	PVR	PIEZAS			
HOLE 25 On-Off	91493099-999	28,00	1			
HOLE 25 1-10V Push Dim*	91493199-999	46,00	1			
HOLE 25 DALI	91493299-999	54,00	1			
CAJA REGISTRO PARA TRIMLESS						
DESCRIPCIÓN	ARTÍCULO	PVR	PIEZAS			
Caja Registro Techo X-Less Blanco	99981000-900	61,00	1			
Caja Registro Techo X-Less Imprimable	99981000-977	61,00	1			

HOLE 50 RECESSED

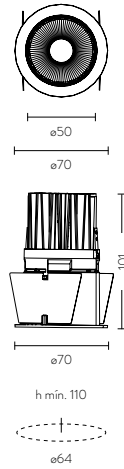

ÓPTICAS (°)	K	LM	W	ARTÍCULO	PVR	PIEZAS
EMPOTRAR						
Spot 20°	2700 CRI98	610	9	91411931-2**	144,00	1
Spot 20°	3000 CRI98	640	9	91411931-3**	144,00	1
Spot 20°	4000 CRI98	700	9	91411931-4**	144,00	1
Flood 35°	2700 CRI98	610	9	91411932-2**	144,00	1
Flood 35°	3000 CRI98	640	9	91411932-3**	144,00	1
Flood 35°	4000 CRI98	700	9	91411932-4**	144,00	1

EQUIPOS

DESCRIPCIÓN	ARTÍCULO	PVR	PIEZAS
HOLE 50 On-Off	91491099-999	29,00	1
HOLE 50 1-10V Push Dim*	91491199-999	43,00	1
HOLE 50 DALI	91491299-999	55,00	1

HOLE 25 TRIMLESS

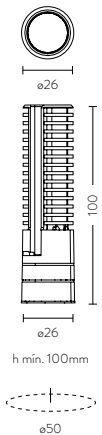

ÓPTICAS (°)	K	LM	W	ARTÍCULO	PVR	PIEZAS
TRIMLESS						
Spot 15°	2700 CRI90	254	3,5	91420911-2**	99,00	1
Spot 15°	3000 CRI90	266	3,5	91420911-3**	99,00	1
Spot 15°	4000 CRI90	299	3,5	91420911-4**	99,00	1
Flood 35°	2700 CRI90	215	3,5	91420912-2**	99,00	1
Flood 35°	3000 CRI90	222	3,5	91420912-3**	99,00	1
Flood 35°	4000 CRI90	249	3,5	91420912-4**	99,00	1

EQUIPOS

DESCRIPCIÓN	CONTROL	ARTÍCULO	PVR	PIEZAS
HOLE 25 On-Off		91493099-999	28,00	1
HOLE 25 1-10V Push Dim*		91493199-999	46,00	1
HOLE 25 DALI		91493299-999	54,00	1

X-LESS ACCESORIOS

DESCRIPCIÓN	ARTÍCULO	PVR	PIEZAS
Accesorio X-Less Hole 25	99920259-199	38,00	1
Accesorio X-Less de unión Hole 25	99920279-999	5,90	1

HOLE 25 PLUS TRIMLESS

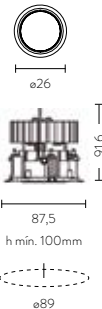

ÓPTICAS (°)	K	LM	W	ARTÍCULO	PVR	PIEZAS
TRIMLESS						
Spot 15°	2700 CRI90	430	9,5	91420983-2**	201,00	1
Spot 15°	3000 CRI90	440	9,5	91420983-3**	201,00	1
Spot 15°	4000 CRI90	550	9,5	91420983-4**	201,00	1

EQUIPOS

DESCRIPCIÓN	CONTROL	ARTÍCULO	PVR	PIEZAS
HOLE 25 PLUS On-Off		91493399-999	26,00	1
HOLE 25 PLUS DALI		91493599-999	75,00	1
HOLE 25 PLUS 1-10V Push Dim*		91493499-999	56,00	1

CAJA REGISTRO

DESCRIPCIÓN	ARTÍCULO	PVR	PIEZAS
Caja Registro Techo X-Less Blanco	99981000-900	61,00	1
Caja Registro Techo X-Less Imprimable	99981000-977	61,00	1

HOLE 50 TRIMLESS

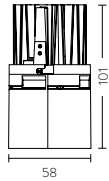
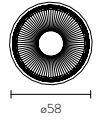

ÓPTICAS (°)	K	LM	W	ARTÍCULO	PVR	PIEZAS
-------------	---	----	---	----------	-----	--------

TRIMLESS

Spot 20°	2700 CRI98	610	9	91421931-200	133,00	1
Spot 20°	3000 CRI98	640	9	91421931-300	133,00	1
Spot 20°	4000 CRI98	700	9	91421931-400	133,00	1
Flood 35°	2700 CRI98	610	9	91421932-2**	133,00	1
Flood 35°	3000 CRI98	640	9	91421932-3**	133,00	1

EQUIPOS

DESCRIPCIÓN	CONTROL	ARTÍCULO	PVR	PIEZAS
HOLE 50	On-Off	91491099-999	29,00	1
HOLE 50	1-10V Push Dim*	91491199-999	43,00	1
HOLE 50	DALI	91491299-999	55,00	1

X-LESS ACCESORIOS

DESCRIPCIÓN	ARTÍCULO	PVR	PIEZAS
Accesorio X-Less Hole 50	99920509-199	43,00	1
Accesorio X-Less de unión Hole 50	99920529-999	6,60	1

703.22

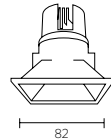

ÓPTICAS (°)	K	LM	W	ARTÍCULO	PVR	PIEZAS
-------------	---	----	---	----------	-----	--------

ON-OFF, EMPOTRADO (IP44)

Spot 20°	2700	680	7,5	703220**-282	39,00	1
Spot 20°	3000	680	7,5	703220**-283	39,00	1
Spot 20°	4000	680	7,5	703220**-284	39,00	1
W. Flood 40°	2700	680	7,5	703220**-482	39,00	1
W. Flood 40°	3000	680	7,5	703220**-483	39,00	1
W. Flood 40°	4000	680	7,5	703220**-484	39,00	1

DALI / PUSH, EMPOTRADO (IP44)

Spot 20°	2700	680	7,5	703223**-282	58,00	1
Spot 20°	3000	680	7,5	703223**-283	58,00	1
Spot 20°	4000	680	7,5	703223**-284	58,00	1
W. Flood 40°	2700	680	7,5	703223**-482	58,00	1
W. Flood 40°	3000	680	7,5	703223**-483	58,00	1
W. Flood 40°	4000	680	7,5	703223**-484	58,00	1

703.23

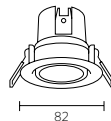

ÓPTICAS (°)	K	LM	W	ARTÍCULO	PVR	PIEZAS
-------------	---	----	---	----------	-----	--------

ON-OFF, EMPOTRADO

Spot 20°	2700	700	7,5	703230**-282	37,50	1
Spot 20°	3000	700	7,5	703230**-283	37,50	1
Spot 20°	4000	700	7,5	703230**-284	37,50	1
W. Flood 40°	2700	700	7,5	703230**-482	37,50	1
W. Flood 40°	3000	700	7,5	703230**-483	37,50	1
W. Flood 40°	4000	700	7,5	703230**-484	37,50	1

DALI / PUSH, EMPOTRADO

Spot 20°	2700	700	7,5	703233**-282	57,00	1
Spot 20°	3000	700	7,5	703233**-283	57,00	1
Spot 20°	4000	700	7,5	703233**-284	57,00	1
W. Flood 40°	2700	700	7,5	703233**-482	57,00	1
W. Flood 40°	3000	700	7,5	703233**-483	57,00	1
W. Flood 40°	4000	700	7,5	703233**-484	57,00	1

703.24

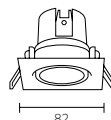

ÓPTICAS (°)	K	LM	W	ARTÍCULO	PVR	PIEZAS
-------------	---	----	---	----------	-----	--------

ON-OFF, EMPOTRADO

Spot 20°	2700	700	7,5	703240**-282	37,50	1
Spot 20°	3000	700	7,5	703240**-283	37,50	1
Spot 20°	4000	700	7,5	703240**-284	37,50	1
W. Flood 40°	2700	700	7,5	703240**-482	37,50	1
W. Flood 40°	3000	700	7,5	703240**-483	37,50	1
W. Flood 40°	4000	700	7,5	703240**-484	37,50	1

DALI / PUSH, EMPOTRADO

Spot 20°	2700	700	7,5	703243**-282	57,00	1
Spot 20°	3000	700	7,5	703243**-283	57,00	1
Spot 20°	4000	700	7,5	703243**-284	57,00	1
W. Flood 40°	2700	700	7,5	703243**-482	57,00	1
W. Flood 40°	3000	700	7,5	703243**-483	57,00	1
W. Flood 40°	4000	700	7,5	703243**-484	57,00	1

703.21

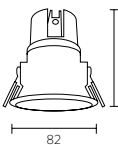

ÓPTICAS (°)	K	LM	W	ARTÍCULO	PVR	PIEZAS
-------------	---	----	---	----------	-----	--------

ON-OFF, EMPOTRADO (IP44)

Spot 20°	2700	680	7,5	703210**-282	39,00	1
Spot 20°	3000	680	7,5	703210**-283	39,00	1
Spot 20°	4000	680	7,5	703210**-284	39,00	1
W. Flood 40°	2700	680	7,5	703210**-482	39,00	1
W. Flood 40°	3000	680	7,5	703210**-483	39,00	1
W. Flood 40°	4000	680	7,5	703210**-484	39,00	1

DALI / PUSH, EMPOTRADO (IP44)

Spot 20°	2700	680	7,5	703213**-282	58,00	1
Spot 20°	3000	680	7,5	703213**-283	58,00	1
Spot 20°	4000	680	7,5	703213**-284	58,00	1
W. Flood 40°	2700	680	7,5	703213**-482	58,00	1
W. Flood 40°	3000	680	7,5	703213**-483	58,00	1
W. Flood 40°	4000	680	7,5	703213**-484	58,00	1

703.25						
ÓPTICAS (°)	K	LM	W	ARTÍCULO	PVR	PIEZAS
ON-OFF, EMPOTRADO (IP65)						
W. Flood 40°	2700	680	7,5	703250**-482	58,50	1
W. Flood 40°	3000	680	7,5	703250**-483	58,50	1
W. Flood 40°	4000	680	7,5	703250**-484	58,50	1
DALI / PUSH, EMPOTRADO (IP65)						
W. Flood 40°	2700	680	7,5	703253**-482	77,50	1
W. Flood 40°	3000	680	7,5	703253**-483	77,50	1
W. Flood 40°	4000	680	7,5	703253**-484	77,50	1

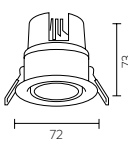

MÓDULOS						
ÓPTICAS (°)	K	LM	W	ARTÍCULO	PVR	PIEZAS
ON-OFF, EMPOTRADO (IP65)						
Spot 20°	2700	1030	12	704000**-282	47,00	1
Spot 20°	3000	1070	12	704000**-283	47,00	1
Spot 20°	4000	1100	12	704000**-284	47,00	1
W. Flood 40°	2700	1015	12	704000**-482	47,00	1
W. Flood 40°	3000	1060	12	704000**-483	47,00	1
W. Flood 40°	4000	1090	12	704000**-484	47,00	1
DALI / PUSH, EMPOTRADO (IP65)						
Spot 20°	2700	1030	12	704003**-282	85,00	1
Spot 20°	3000	1070	12	704003**-283	85,00	1
Spot 20°	4000	1100	12	704003**-284	85,00	1
W. Flood 40°	2700	1015	12	704003**-482	85,00	1
W. Flood 40°	3000	1060	12	704003**-483	85,00	1
W. Flood 40°	4000	1090	12	704003**-484	85,00	1

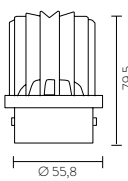

MARCOS				
DESCRIPCIÓN	ARTÍCULO	PVR	PIEZAS	
Marco Orientable Redondo	704239**-039	9,20	1	
Marco Orientable Cuadrado	704249**-039	9,20	1	
Marco Confort Redondo	704219**-039	10,50	1	

	Marco Confort Redondo L	704289**-039	11,80	1
	Marco Confort Cuadrado	704229**-039	10,50	1

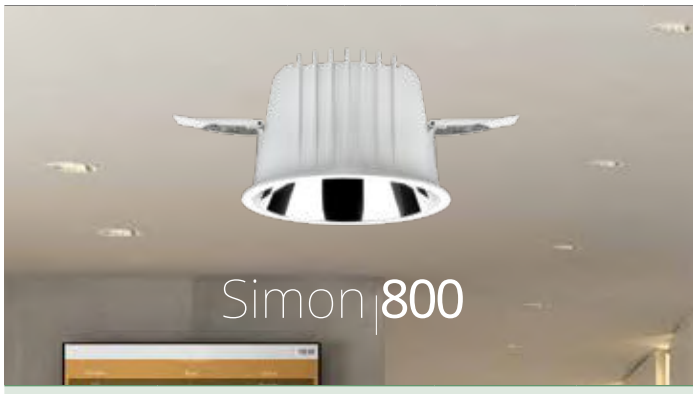

PROJECT
DOWNLIGHT

	Downlight 800.21 3000K Wide Flood 15W	80021030-683	75,00	1
	Downlight 800.21 4000K Wide Flood 15W	80021030-684	75,00	1
	Downlight 800.21 3000K Wide Flood DALI 15W	80021330-683	90,00	1
	Downlight 800.21 4000K Wide Flood DALI 15W	80021330-684	90,00	1
	Downlight 800.22 3000K Wide Flood 24W	80022030-683	90,00	1
	Downlight 800.22 4000K Wide Flood 24W	80022030-684	90,00	1
	Downlight 800.22 3000K Wide Flood DALI 24W	80022330-683	105,00	1
	Downlight 800.22 4000K Wide Flood DALI 24W	80022330-684	105,00	1
	Downlight 800.23 3000K Wide Flood 24W	80023030-683	105,00	1
	Downlight 800.23 4000K Wide Flood 24W	80023030-684	105,00	1
	Downlight 800.23 3000K Wide Flood DALI 24W	80023330-683	120,00	1
	Downlight 800.23 4000K Wide Flood DALI 24W	80023330-684	120,00	1
	Downlight 800.24 3000K Flood 35W	80024030-283	114,00	1
	Downlight 800.24 4000K Flood 35W	80024030-284	114,00	1
	Downlight 800.24 3000K Flood DALI 35W	80024330-283	129,00	1
	Downlight 800.24 4000K Flood DALI 35W	80024330-284	129,00	1

REFLECTORES ANTIDESLUMBRANTES				
	Reflector antideslumbrante 800.21	80071900-039	9,00	1
	Reflector antideslumbrante 800.22	80072900-039	12,00	1
	Reflector antideslumbrante 800.23/24	80073900-039	15,00	1

ACCESORIOS				
	Accesorio panel de abeja 800.21	80081938-039	11,00	1
	Accesorio panel de abeja 800.22	80082938-039	14,00	1
	Accesorio panel de abeja 800.23/24	80083938-039	17,00	1
	Accesorio aro extensivo 800.21	80091930-039	9,00	1
	Accesorio aro extensivo 800.22	80092930-039	12,00	1
	Accesorio aro extensivo 800.23/24	80093930-039	15,00	1



Simon 725 Downlights

ESSENTIALS

725.24 / .25 CONFORT

ÓPTICAS (°)	K	LM	W	ARTÍCULO	PVR	PIEZAS
-------------	---	----	---	----------	-----	--------

ON-OFF, EMPOTRADO (IP44)

General 120°	3000	2200	22	72524030-883	66,00	1
General 120°	4000	2300	22	72524030-884	66,00	1
General 120°	3000	3300	37	72525030-883	105,50	1
General 120°	4000	3400	37	72525030-884	105,50	1

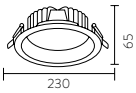

1-10V, EMPOTRADO (IP44)

General 120°	3000	2200	22	72524130-883	102,00	1
General 120°	4000	2300	22	72524130-884	102,00	1
General 120°	3000	3300	37	72525130-883	140,50	1
General 120°	4000	3400	37	72525130-884	140,50	1

DALI-2 / PUSH, EMPOTRADO (IP44)

General 120°	3000	2200	22	72524330-883	124,00	1
General 120°	4000	2300	22	72524330-884	124,00	1
General 120°	3000	3300	37	72525330-883	161,50	1
General 120°	4000	3400	37	72525330-884	161,50	1

725.26 CONFORT

ÓPTICAS (°)	K	LM	W	ARTÍCULO	PVR	PIEZAS
-------------	---	----	---	----------	-----	--------

ON-OFF, EMPOTRADO (IP44)

General 120°	3000	1300	14	72526030-883	39,00	1
General 120°	4000	1400	14	72526030-884	39,00	1

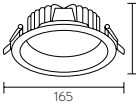

1-10V, EMPOTRADO (IP44)

General 120°	3000	1300	14	72526130-883	75,00	1
General 120°	4000	1400	14	72526130-884	75,00	1

DALI-2 / PUSH, EMPOTRADO (IP44)

General 120°	3000	1300	14	72526330-883	97,00	1
General 120°	4000	1400	14	72526330-884	97,00	1

ACCESORIOS SUPERFICIE

DESCRIPCIÓN	ARTÍCULO	PVR	PIEZAS
Accesorio Superficie Downlight 725.24/25	72534030-039	27,00	1
Accesorio Superficie Downlight 725.26	72536030-039	20,00	1



Simon 640 Downlights

PROJECT

640.10

ÓPTICAS (°)	K	LM	W	ARTÍCULO	PVR	PIEZAS
-------------	---	----	---	----------	-----	--------

ON-OFF / EMPOTRADO

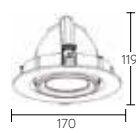

Spot 15°	3000	2500	30	640100**-283	185,00	1
Spot 15°	4000	2600	30	640100**-284	185,00	1
Wide Flood 40°	3000	2500	30	640100**-483	185,00	1
Wide Flood 40°	4000	2600	30	640100**-484	185,00	1
Spot 15°	3000	2100	30	640100**-293	197,00	1
				CRI>92		
Wide Flood 40°	3000	2100	30	640100**-493	197,00	1
				CRI>92		



Simon 712 Downlights

ESSENTIALS

712 EMPOTRADO

ÓPTICAS (°)	K	LM	W	ARTÍCULO	PVR	PIEZAS
-------------	---	----	---	----------	-----	--------

ON-OFF

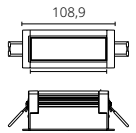

Empotrado General 69°	2700	560	7	71211030-992	108,00	1
Empotrado General 69°	3000	590	7	71211030-993	108,00	1
Empotrado General 69°	2700	1170	12	71212030-992	138,00	1
Empotrado General 69°	3000	1230	12	71212030-993	138,00	1
Empotrado General 69°	2700	560	7	71221030-992	128,00	1
Empotrado General 69°	3000	590	7	71221030-993	128,00	1
Empotrado General 69°	2700	1170	12	71222030-992	158,00	1
Empotrado General 69°	3000	1230	12	71222030-993	158,00	1

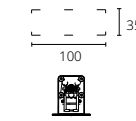

712 TRIMLESS

ÓPTICAS (°)	K	LM	W	ARTÍCULO	PVR	PIEZAS
DALI-2						
On-Off X-Less General 69°	2700	560	7	71211330-992	123,00	1
On-Off X-Less General 69°	3000	590	7	71211330-993	123,00	1
On-Off X-Less General 69°	2700	1170	12	71212330-992	153,00	1
On-Off X-Less General 69°	3000	1230	12	71212330-993	153,00	1
On-Off X-Less General 69°	2700	560	7	71221330-992	143,00	1
On-Off X-Less General 69°	3000	590	7	71221330-993	143,00	1
On-Off X-Less General 69°	2700	1170	12	71222330-992	173,00	1
On-Off X-Less General 69°	3000	1230	12	71222330-993	173,00	1

ACCESORIOS

DESCRIPCIÓN	ARTÍCULO	PVR	PIEZAS
Accesorio Low UGR Downlight 712 100	71291938-039	14,00	1
Accesorio Low UGR Downlight 712 240	71292938-039	17,00	1



719

ÓPTICAS (°)	K	LM	W	ARTÍCULO	PVR	PIEZAS
ON-OFF, SUPERFICIE (PARED-TECHO)						
	3000			71921030-983	10,40	1
	4000			71921030-984	10,40	1
	5700			71921030-986	10,40	1
DETECTOR, SUPERFICIE (PARED-TECHO)						
	3000			71922030-983	17,30	1
	4000			71922030-984	17,30	1
	5700			71922030-986	17,30	1



PROJECT

640.30

ÓPTICAS (°)	K	LM	W	ARTÍCULO	PVR	PIEZAS
ON-OFF / SUSPENSIÓN						
Wide Flood 40°	3000	2500	30	640300**-483	209,00	1
Wide Flood 40°	4000	2600	30	640300**-484	209,00	1
Wide Flood 40°	3000	2100	30	640300**-493	249,00	1
				CRI>92		

640.31

ÓPTICAS (°)	K	LM	W	ARTÍCULO	PVR	PIEZAS
ON-OFF / SUSPENSIÓN						
Spot 15°	3000	1300	16	640310**-283	174,00	1
Spot 15°	4000	1400	16	640310**-284	174,00	1
Wide Flood 40°	3000	1300	16	640310**-483	174,00	1
Wide Flood 40°	4000	1400	16	640310**-484	174,00	1
Spot 15°	3000	1000	16	640310**-293	214,00	1
				CRI>92		
Wide Flood 40°	3000	1000	16	640310**-493	214,00	1
				CRI>92		

640.32

ÓPTICAS (°)	K	LM	W	ARTÍCULO	PVR	PIEZAS
ON-OFF / SUSPENSIÓN						
Spot 20°	3000	800	9	640320**-283	128,00	1
Spot 20°	4000	900	9	640320**-284	128,00	1
Spot 20°	3000	650	9	640320**-293	168,00	1
				CRI>92		

ACCESORIOS

DESCRIPCIÓN	ARTÍCULO	PVR	PIEZAS
Accesorio suspensión 640.30	640901**-039	18,00	1
Accesorio suspensión 640.31	640902**-039	18,00	1
Accesorio suspensión 640.32	640903**-039	18,00	1

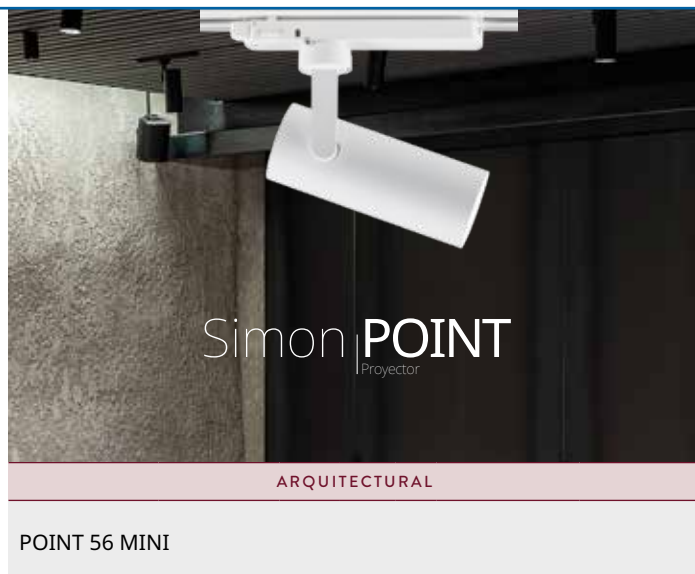

ÓPTICAS (°)	K	LM	W	ARTÍCULO	PVR	PIEZAS
CARRIL						
Spot	3000	2500	30	65004030-293	150,00	1
Spot	4000	2600	30	65004030-294	150,00	1
Flood	3000	2100	30	65004030-393	150,00	1
Flood	4000	2500	30	65004030-394	150,00	1
Spot	3000	2600	30	65004038-293	150,00	1
Spot	4000	2100	30	65004038-294	150,00	1
Flood	3000	2500	30	65004038-393	150,00	1
Flood	4000	2600	30	65004038-394	150,00	1
Wide Flood	3000	2100	30	65004030-493	150,00	1
Wide Flood	4000	2500	30	65004030-494	150,00	1
Wide Flood	3000	2600	30	65004038-493	150,00	1
Wide Flood	4000	2100	30	65004038-494	150,00	1

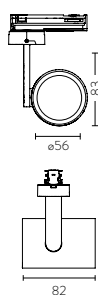
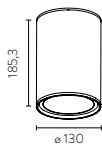

ÓPTICAS (°)	K	LM	W	ARTÍCULO	PVR	PIEZAS
OBD / CARRIL MONOFÁSICO*						
Spot 18°	2700	1000	13,5	92011661-2**	233,00	1
Spot 18°	3000	1050	13,5	92011661-3**	233,00	1
Spot 18°	4000	1100	13,5	92011661-4**	233,00	1
Flood 30°	2700	950	13,5	92011662-2**	233,00	1
Flood 30°	3000	1000	13,5	92011662-3**	233,00	1
Flood 30°	4000	1050	13,5	92011662-4**	233,00	1
Wide Flood 45°	2700	1000	13,5	92011663-2**	233,00	1
Wide Flood 45°	3000	1050	13,5	92011663-3**	233,00	1
Wide Flood 45°	4000	1100	13,5	92011663-4**	233,00	1

ON-OFF / CARRIL TRIFÁSICO						
Spot 18°	2700	1000	14	92061011-2**	219,00	1
Spot 18°	3000	1050	14	92061011-3**	219,00	1
Spot 18°	4000	1100	14	92061011-4**	219,00	1
Flood 30°	2700	950	14	92061012-2**	219,00	1
Flood 30°	3000	1000	14	92061012-3**	219,00	1
Flood 30°	4000	1050	14	92061012-4**	219,00	1
Wide Flood 45°	2700	1000	14	92061013-2**	219,00	1
Wide Flood 45°	3000	1050	14	92061013-3**	219,00	1
Wide Flood 45°	4000	1100	14	92061013-4**	219,00	1

DALI / CARRIL TRIFÁSICO						
Spot 18°	2700	1000	14	92061311-2**	278,00	1
Spot 18°	3000	1050	14	92061311-3**	278,00	1
Spot 18°	4000	1100	14	92061311-4**	278,00	1
Flood 30°	2700	950	14	92061312-2**	278,00	1
Flood 30°	3000	1000	14	92061312-3**	278,00	1
Flood 30°	4000	1050	14	92061312-4**	278,00	1
Wide Flood 45°	2700	1000	14	92061313-2**	278,00	1
Wide Flood 45°	3000	1050	14	92061313-3**	278,00	1
Wide Flood 45°	4000	1100	14	92061313-4**	278,00	1

EQUIPOS ON-OFF PARA CARRIL MONOFÁSICO						
DESCRIPCIÓN	W	ARTÍCULO	PVR	PIEZAS		
Equipo 72W	64	91793901-999	114,00	1		
Equipo 100W	90	91793902-999	120,00	1		
Equipo 240W	216	91793903-999	133,00	1		

ACCESORIOS				
DESCRIPCIÓN	ARTÍCULO	PVR	PIEZAS	
Accesorio Panel de Abeja	92099999-919	20,00	1	
Accesorio en Cruz	92099999-929	20,00	1	
Accesorio Lente Extensiva	92099999-999	20,00	1	

POINT 56

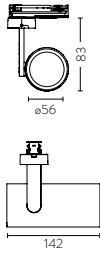

ÓPTICAS (°)	K	LM	W	ARTÍCULO	PVR	PIEZAS
OBD / CARRIL MONOFÁSICO*						
Spot 18°	2700	1350	19	92021661-2**	259,00	1
Spot 18°	3000	1450	19	92021661-3**	259,00	1
Spot 18°	4000	1500	19	92021661-4**	259,00	1
Flood 30°	2700	1300	19	92021662-2**	259,00	1
Flood 30°	3000	1350	19	92021662-3**	259,00	1
Flood 30°	4000	1400	19	92021662-4**	259,00	1
Wide Flood 45°	2700	1300	19	92021663-2**	259,00	1
Wide Flood 45°	3000	1400	19	92021663-3**	259,00	1
Wide Flood 45°	4000	1450	19	92021663-4**	259,00	1

ON-OFF / CARRIL TRIFÁSICO

Spot 18°	2700	1350	21	92062011-2**	239,00	1
Spot 18°	3000	1450	21	92062011-3**	239,00	1
Spot 18°	4000	1500	21	92062011-4**	239,00	1
Flood 30°	2700	1300	21	92062012-2**	239,00	1
Flood 30°	3000	1350	21	92062012-3**	239,00	1
Flood 30°	4000	1400	21	92062012-4**	239,00	1
Wide Flood 45°	2700	1300	21	92062013-2**	239,00	1
Wide Flood 45°	3000	1400	21	92062013-3**	239,00	1
Wide Flood 45°	4000	1450	21	92062013-4**	239,00	1

DALI / CARRIL TRIFÁSICO

Spot 18°	2700	1350	21	92062311-2**	292,00	1
Spot 18°	3000	1450	21	92062311-3**	292,00	1
Spot 18°	4000	1500	21	92062311-4**	292,00	1
Flood 30°	2700	1300	21	92062312-2**	292,00	1
Flood 30°	3000	1350	21	92062312-3**	292,00	1
Flood 30°	4000	1400	21	92062312-4**	292,00	1
Wide Flood 45°	2700	1300	21	92062313-2**	292,00	1
Wide Flood 45°	3000	1400	21	92062313-3**	292,00	1
Wide Flood 45°	4000	1450	21	92062313-4**	292,00	1

EQUIPOS ON-OFF PARA CARRIL MONOFÁSICO

DESCRIPCIÓN	W	ARTÍCULO	PVR	PIEZAS
Equipo 72W	64	91793901-999	114,00	1
Equipo 100W	90	91793902-999	120,00	1
Equipo 240W	216	91793903-999	133,00	1

ACCESORIOS

DESCRIPCIÓN	ARTÍCULO	PVR	PIEZAS
Accesorio Panel de Abeja	92099999-919	20,00	1
Accesorio en Cruz	92099999-929	20,00	1
Accesorio Lente Extensiva	92099992-999	20,00	1



Simon 615
Proyector

PROJECT

615.00

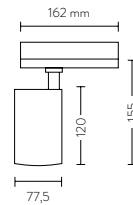

ÓPTICAS (°)	K	LM	W	ARTÍCULO	PVR	PIEZAS
ON-OFF / CARRIL TRIFÁSICO						
Spot 17°	2700	1700	23	615000**-282	217,00	1
Spot 17°	3000	1700	23	615000**-283	217,00	1
Spot 17°	4000	2200	23	615000**-284	217,00	1
Flood 36°	2700	2000	25	615000**-382	217,00	1
Flood 36°	3000	2000	25	615000**-383	217,00	1
Flood 36°	4000	2500	25	615000**-384	217,00	1
Wide Flood 60°	2700	2000	25	615000**-482	217,00	1
Wide Flood 60°	3000	2000	25	615000**-483	217,00	1
Wide Flood 60°	4000	2500	25	615000**-484	217,00	1

DALI / CARRIL TRIFÁSICO

Spot 17°	2700	1700	23	615003**-282	274,00	1
Spot 17°	3000	1700	23	615003**-283	274,00	1
Spot 17°	4000	2200	23	615003**-284	274,00	1
Flood 36°	2700	2000	25	615003**-382	274,00	1
Flood 36°	3000	2000	25	615003**-383	274,00	1
Flood 36°	4000	2500	25	615003**-384	274,00	1
Wide Flood 60°	2700	2000	25	615003**-482	274,00	1
Wide Flood 60°	3000	2000	25	615003**-483	274,00	1
Wide Flood 60°	4000	2500	25	615003**-484	274,00	1

ACCESORIOS

DESCRIPCIÓN	ARTÍCULO	PVR	PIEZAS
Panal abeja 615 negro	61590038-039	23,00	1



Simon 629 Proyector

ESSENTIALS

629.00

	ÓPTICAS (°)	K	LM	W	ARTÍCULO	PVR	PIEZAS
SPOTLIGHT TRACK							
	Spot	3000	2100	25	62902030-283	94,00	1
	Spot	4000	2300	25	62902030-284	94,00	1
	Flood	3000	2100	25	62902030-383	94,00	1
	Flood	4000	2300	25	62902030-384	94,00	1
	Spot	3000	2100	25	62902038-283	94,00	1
	Spot	4000	2300	25	62902038-284	94,00	1
	Flood	3000	2100	25	62902038-383	94,00	1
	Flood	4000	2300	25	62902038-384	94,00	1

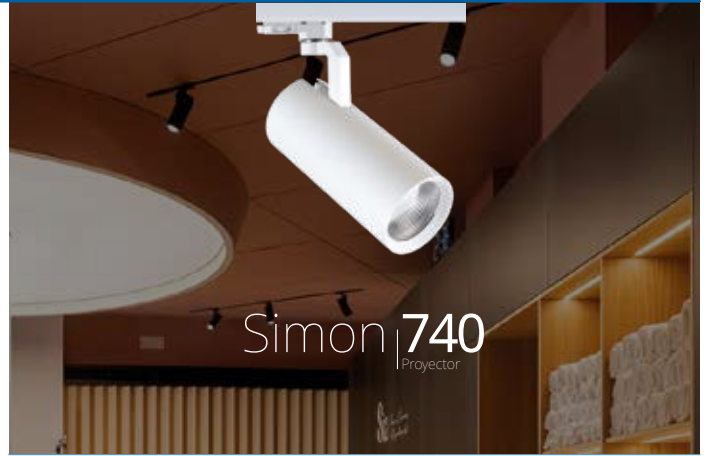

Simon 740 Proyector

ESSENTIALS

740.00

	ÓPTICAS (°)	K	LM	W	ARTÍCULO	PVR	PIEZAS
ON - OFF, CARRIL TRIFÁSICO							
	Spot 15°	3000	1780	20	740010**283	135,50	1
	Flood 25°	3000	1780	20	740010**383	135,50	1
	W. Flood 47°	3000	1780	20	740010**483	135,50	1
	Spot 15°	4000	1830	20	740010**284	135,50	1
	Flood 25°	4000	1830	20	740010**384	135,50	1
	W. Flood 47°	4000	1830	20	740010**484	135,50	1
DALI, CARRIL TRIFÁSICO							
	Spot 17°	3000	1780	20	740013**283	271,50	1
	Flood 27°	3000	1780	20	740013**383	271,50	1
	W. Flood 47°	3000	1780	20	740013**483	271,50	1
	Spot 17°	4000	1830	20	740013**283	271,50	1
	Flood 27°	4000	1830	20	740013**383	271,50	1
	W. Flood 47°	4000	1830	20	740013**483	271,50	1



Simon 899 Carril

ESSENTIALS

ARQUITECTURAL

CARRIL TRIFÁSICO

DESCRIPCIÓN	ARTÍCULO	PVR	PIEZAS
Carril trifásico 1 m	89920130-039	37,00	1
	89920133-039	37,00	1
	89920138-039	37,00	1
Carril trifásico 2 m	89920230-039	70,50	1
	89920233-039	70,50	1
	89920238-039	70,50	1
Carril trifásico 3 m	89920330-039	102,50	1
	89920333-039	102,50	1
	89920338-039	102,50	1
Carril trifásico empotrar 1 m	89930138-039	55,50	1
	89930130-039	55,50	1
Carril trifásico empotrar 2 m	89930238-039	99,00	1
	89930230-039	99,00	1
Carril trifásico empotrar 3 m	89930338-039	142,00	1
	89930330-039	142,00	1

CARRIL TRIFÁSICO REGULABLE

DESCRIPCIÓN	ARTÍCULO	PVR	PIEZAS
Carril trifásico regulable 1 m	89921138-039	62,00	1
	89921130-039	62,00	1
Carril trifásico regulable 2 m	89921238-039	105,00	1
	89921230-039	105,00	1
Carril trifásico regulable 3 m	89921338-039	148,00	1
	89921330-039	148,00	1
Carril tri. regulable empotrar 1 m	89931138-039	81,00	1
	89931130-039	81,00	1
Carril tri. regulable empotrar 2 m	89931238-039	136,00	1
	89931230-039	136,00	1
Carril tri. regulable empotrar 3 m	89931338-039	173,00	1
	89931330-039	173,00	1

ACCESORIOS

DESCRIPCIÓN	ARTÍCULO	PVR	PIEZAS
Alimentación con tierra izquierda	89910130-039	16,50	1
	89910138-039	16,50	1
Alimentación con tierra derecha	89910230-039	16,50	1
	89910238-039	16,50	1
Alimentación intermedia	89910330-039	37,00	1
	89910338-039	37,00	1
Conector de continuidad sin alimentación	89910430-039	11,20	1
	89910438-039	11,20	1

	Conector flexible	89910530-039	80,50	1
		89910538-039	80,50	1
	Conector L con tierra exterior	89910630-039	49,50	1
		89910638-039	49,50	1
	Conector L con tierra interior	89910730-039	49,50	1
		89910738-039	49,50	1
	Conector T con tierra interior izquierda	89910830-039	55,50	1
		89910838-039	55,50	1
	Conector T con tierra exterior derecha	89910930-039	55,50	1
		89910938-039	55,50	1
	Conector T con tierra interior derecha	89911030-039	55,50	1
		89911038-039	55,50	1
	Conector T con tierra exterior izquierda	89911130-039	55,50	1
		89911138-039	55,50	1
	Conector en cruz	89911230-039	73,00	1
		89911238-039	73,00	1
	Tapa final	89911430-039	4,10	1
		89911438-039	4,10	1
	Tapa Acc. lineal empotrar	89911738-039	15,00	1
		89911730-039	15,00	1
	Tapa Acc. L, T, X empotrar	89911838-039	17,50	1
		89911830-039	17,50	1
	Kit de suspensión	89911330-039	21,00	1
		89911338-039	21,00	1
	Base Superficie para proyector	89911530-039	35,00	1
		89911538-039	35,00	1
	Base Empotrable para proyector *	89911630-039	32,50	1
		89911638-039	32,50	1





ACCESORIOS REGULABLES

	Alimentación con tierra derecha regulable	89940238-039	35,00	1
		89940230-039	35,00	1
	Alimentación con tierra izquierda regulable	89940138-039	35,00	1
		89940130-039	35,00	1
	Alimentación intermedia regulable	89940338-039	60,50	1
		89940330-039	60,50	1
	Conector de continuidad sin alimentación regulable	89940438-039	25,00	1
		89940430-039	25,00	1
	Conector flexible regulable	89940538-039	119,50	1
		89940530-039	119,50	1
	Conector L con tierra exterior regulable	89940638-039	68,00	1
		89940630-039	68,00	1
	Conector L con tierra interior regulable	89940738-039	68,00	1
		89940730-039	68,00	1
	Conector T con tierra interior izquierda regulable	89940838-039	92,50	1
		89940830-039	92,50	1
	Conector T con tierra exterior derecha regulable	89940938-039	92,50	1
		89940930-039	92,50	1
	Conector T con tierra interior derecha regulable	89941038-039	92,50	1
		89941030-039	92,50	1
	Conector T con tierra exterior izquierda regulable	89941138-039	92,50	1
		89941130-039	92,50	1
	Conector en cruz regulable	89941238-039	117,50	1
		89941230-039	117,50	1
	Tapa Acc. lineal regulable empotrar	89941738-039	16,00	1
		89941730-039	16,00	1
	Tapa Acc. L, T, X regulable empotrar	89941838-039	18,50	1
		89941830-039	18,50	1

CARRIL MONOFÁSICO

DESCRIPCIÓN	ARTÍCULO	PVR	PIEZAS
 Carril monofásico 1m Superficie	89961930-039	34,00	1
	89961938-039	34,00	1
Carril monofásico 2m Superficie	89962930-039	64,00	1
	89962938-039	64,00	1
Carril monofásico 3m Superficie	89963930-039	93,00	1
	89963938-039	93,00	1
Carril monofásico 1m Empotrado	89964930-039	56,00	1
	89964938-039	56,00	1
Carril monofásico 2m Empotrado	89965930-039	95,00	1
	89965938-039	95,00	1
Carril monofásico 3m Empotrado	89966930-039	134,00	1
	89966938-039	134,00	1

ACCESORIOS CARRIL MONOFÁSICO

DESCRIPCIÓN	ARTÍCULO	PVR	PIEZAS
SUPERFICIE / EMPOTRADO			
 Tapa final Carril monofásico	89969930-112	2,20	1
	89969938-112	2,20	1
Tapa final con alimentación izquierda Carril monofásico	89969930-100	14,50	1
	89969938-100	14,50	1
Tapa final con alimentación derecha Carril monofásico	89969930-101	14,50	1
	89969938-101	14,50	1
Tapa conector unión Carril monofásico	89969930-113	5,60	1
	89969938-113	5,60	1
 Conector flexible Carril monofásico	89969930-104	59,00	1
	89969938-104	59,00	1
 Conector L con alimentación izquierda Carril monofásico	89969930-105	38,00	1
	89969938-105	38,00	1
Conector L con alimentación derecha Carril monofásico	89969930-106	38,00	1
	89969938-106	38,00	1
 Conector T con alimentación interior izquierda Carril monofásico	89969930-107	51,00	1
	89969938-107	51,00	1
Conector T con alimentación interior derecha Carril monofásico	89969930-108	51,00	1
	89969938-108	51,00	1
Conector T con alimentación exterior izquierda Carril monofásico	89969930-109	51,00	1
	89969938-109	51,00	1
Conector T con alimentación exterior derecha Carril monofásico	89969930-110	51,00	1
	89969938-110	51,00	1
 Conector en cruz con alimentación Carril monofásico	89969930-111	66,00	1
	89969938-111	66,00	1
Tapa conector en cruz Carril monofásico	89969930-114	5,60	1
	89969938-114	5,60	1

SUPERFICIE

Conector de unión Superficie Carril monofásico	89969930-102	10,00	1
	89969938-102	10,00	1

EMPOTRADO

Conector de unión Empotrado Carril monofásico	89969930-103	12,80	1
	89969938-103	12,80	1



SUSPENDIDO

Kit Suspensión Carril monofásico	89969930-115	19,00	1
	89969938-115	19,00	1

EQUIPOS

DESCRIPCIÓN	ARTÍCULO	PVR	PIEZAS
Equipo 72W	91793901-999	114,00	1
Equipo 100W	91793902-999	120,00	1
Equipo 240W	91793903-999	133,00	1

CAJA REGISTRO / TRIMLESS

DESCRIPCIÓN	ARTÍCULO	PVR	PIEZAS
 Caja Registro Techo X-Less Blanco	99981000-900	61,00	1
 Caja Registro Techo X-Less Imprimación	99981000-977	61,00	1

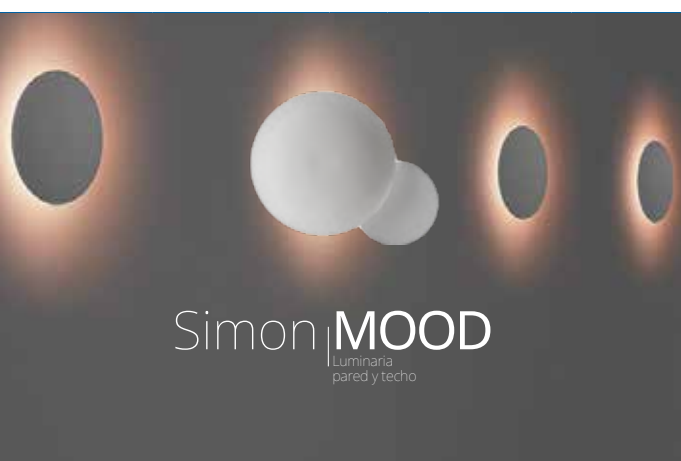

MOOD 25

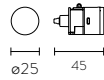
	K	LM	W	ARTÍCULO	PVR	PIEZAS
	2700	24	0,7	91620104-299	44,00	1
	3000	24	0,7	91620104-399	44,00	1
	4000	26	0,7	91620104-499	44,00	1

X-LESS ACCESORIOS

DESCRIPCIÓN	ARTÍCULO	PVR	PIEZAS
Accesorio X-Less 25	99920919-999	25,00	

EQUIPOS

DESCRIPCIÓN	CONTROL	ARTÍCULO	PVR	PIEZAS
De 1 a 6 unidades	1-10V	98820416-999	34,00	1
De 1 a 8 unidades	On-Off	98820318-999	29,00	1
De 1 a 20 unidades	DALI	98820512-999	57,00	1

CAJA DE REGISTRO

DESCRIPCIÓN	ARTÍCULO	PVR	PIEZAS
 Caja Registro Techo X-Less Blanco	99981000-900	61,00	1
 Caja Registro Techo X-Less Imprimable	99981000-977	61,00	1

MOOD 110

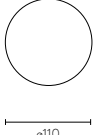
	K	LM	W	ARTÍCULO	PVR	PIEZAS
	2700	90	1,6	91621104-299	73,00	1
	3000	92	1,6	91621104-399	73,00	1
	4000	96	1,6	91621104-499	73,00	1

DALI* / TRIMLESS

2200-4000	76-96	3,8	91621104-899	91,00	1
-----------	-------	-----	--------------	-------	---

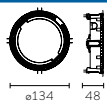

X-LESS ACCESORIOS

DESCRIPCIÓN	ARTÍCULO	PVR	PIEZAS
Accesorio X-Less 110	99921919-999	32,00	1

EQUIPOS

DESCRIPCIÓN	CONTROL	ARTÍCULO	PVR	PIEZAS
De 1 a 5 unidades	On-Off	98821315-999	34,00	1
De 1 a 5 unidades	1-10V	98821415-999	40,00	1
De 1 a 5 unidades	DALI	98821515-999	63,00	1
1 ud para RGB/2200-4000K	Dali*	98820512-999	57,00	1



ARQUITECTURAL

SLIM SUSPENDIDA 48V

ÓPTICAS (°)	K	LM	W	ARTÍCULO	PVR	PIEZAS
-------------	---	----	---	----------	-----	--------

OBD

Simétrica	2700	3040	42	91713010-2**	693,00	1
Simétrica	3000	3270	42	91713010-3**	693,00	1
Simétrica	4000	3460	42	91713010-4**	693,00	1
Simétrica	2700	4050	56	91713110-2**	747,00	1
Simétrica	3000	4360	56	91713110-3**	747,00	1
Simétrica	4000	4620	56	91713110-4**	747,00	1

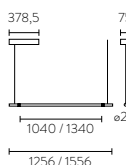

DALI

Simétrica	2700	3040	42	91813010-2**	750,00	1
Simétrica	3000	3270	42	91813010-3**	750,00	1
Simétrica	4000	3460	42	91813010-4**	750,00	1
Simétrica	2700	4050	56	91813110-2**	820,00	1
Simétrica	3000	4360	56	91813110-3**	820,00	1
Simétrica	4000	4620	56	91813110-4**	820,00	1



ARQUITECTURAL

SIMON LOOP



LOOP 3000K DALI BLANCO

DESCRIPCIÓN	ARTÍCULO	PVR	PIEZAS
Loop 3000K Dali blanco	91239954-300	195,00	1



LOOP 3000K DALI NEGRO

DESCRIPCIÓN	ARTÍCULO	PVR	PIEZAS
Loop 3000K Dali negro	91239954-300	195,00	1

ACCESORIO



DESCRIPCIÓN	ARTÍCULO	PVR	PIEZAS
Accesorio X-Less 110 M2	99931109-199	25,00	1



ESSENTIALS

707.30

ÓPTICAS (°)	K	LM	W	ARTÍCULO	PVR	PIEZAS
-------------	---	----	---	----------	-----	--------

ON-OFF, SUPERFICIE (PARED)

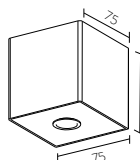

Flood general 30-60°	3000	500	10	70730130-683	94,00	1
Flood general 30-60°	3000	500	10	70730133-683	94,00	1
Flood general 30-60°	4000	700	10	70730130-684	94,00	1
Flood general 30-60°	4000	700	10	70730133-684	94,00	1

707.31

ÓPTICAS (°)	K	LM	W	ARTÍCULO	PVR	PIEZAS
-------------	---	----	---	----------	-----	--------

ON-OFF, SUPERFICIE (PARED)

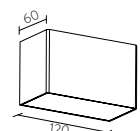

Difusa 70°	3000	670	12	70731130-883	108,00	1
Difusa 70°	3000	670	12	70731133-883	108,00	1
Difusa 70°	4000	750	12	70731130-884	108,00	1
Difusa 70°	4000	750	12	70731133-884	108,00	1



Simon 717
Luminaria pared y techo

ESSENTIALS

717

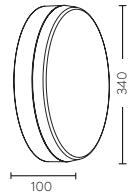

ÓPTICAS (°)	K	LM	W	ARTÍCULO	PVR	PIEZAS
ON-OFF, SUPERFICIE (PARED-TECHO)						
General 120°	3000	1400	21	71730030-983	90,00	1
General 120°	4000	1500	21	71730030-984	90,00	1
DETECTOR, SUPERFICIE (PARED-TECHO)						
General 120°	3000	1400	21	71730530-983	136,00	1
General 120°	4000	1500	21	71730530-984	136,00	1



Simon 720
Luminaria modular

PROJECT

720.60 ADVANCE

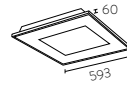

ÓPTICAS	K	LM	W	ARTÍCULO	PVR	PIEZAS
CONTROL ON-OFF						
Microprismatizada 90°	3000	3200	28	72060040-683	256,00	1
	4000	3400	28	72060040-684	256,00	1
Translúcida 120°	3000	3600	28	72060040-883	184,00	1
	4000	4100	28	72060040-884	184,00	1
CONTROL 1-10V						
Microprismatizada 90°	3000	3200	28	72060140-683	291,00	1
	4000	3400	28	72060140-684	291,00	1
Translúcida 120°	3000	3600	28	72060140-883	250,00	1
	4000	4100	28	72060140-884	250,00	1
CONTROL DALI						
Microprismatizada 90°	3000	3200	28	72060340-683	321,00	1
	4000	3400	28	72060340-684	321,00	1
Translúcida 120°	3000	3600	28	72060340-883	256,00	1
	4000	4100	28	72060340-884	256,00	1

720.61 ADVANCE

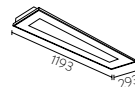

ÓPTICAS	K	LM	W	ARTÍCULO	PVR	PIEZAS
CONTROL ON-OFF						
Microprismatizada 90°	3000	3200	28	72061040-683	273,00	1
	4000	3400	28	72061040-684	273,00	1
Translúcida 120°	3000	3600	28	72061040-883	208,00	1
	4000	4100	28	72061040-884	208,00	1
CONTROL 1-10V						
Microprismatizada 90°	3000	3200	28	72061140-683	309,00	1
	4000	3400	28	72061140-684	309,00	1
Translúcida 120°	3000	3600	28	72061140-883	268,00	1
	4000	4100	28	72061140-884	268,00	1
CONTROL DALI						
Microprismatizada 90°	3000	3200	28	72061340-683	339,00	1
	4000	3400	28	72061340-684	339,00	1
Translúcida 120°	3000	3600	28	72061340-883	273,00	1
	4000	4100	28	72061340-884	273,00	1

720.60 BIODINÁMICA

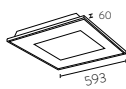

ÓPTICAS	K	LM	W	ARTÍCULO	PVR	PIEZAS
CONTROL DALI DT8						
Microprisma-tizada 90°	2700-5700	4000	34	72060340-688	627,00	1
Translúcida 120°	2700-5700	4000	34	72060340-888	578,00	1

720.61 BIODINÁMICA

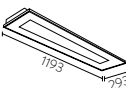

ÓPTICAS	K	LM	W	ARTÍCULO	PVR	PIEZAS
CONTROL DALI DT8						
Microprisma-tizada 90°	2700-5700	4000	34	72061340-688	646,00	1
Translúcida 120°	2700-5700	4000	34	72060340-888	578,00	1

ACCESORIOS

DESCRIPCIÓN	ARTÍCULO	PVR	PIEZAS
Kit conexión rápida 2+2 polos	72095830-039	34,00	1
Accesorio para techos escayola luminaria 720 60x60	72095030-039	51,00	1
Accesorio para techos escayola luminaria 720 120x30	72095130-039	62,50	1
Accesorio perfil oculto/semioculto para luminaria 720	72095530-039	44,00	1
Accesorio perfil oculto para luminaria 720 60x60	72095630-039	79,50	1
Accesorio perfil oculto para luminaria 720 120x30	72095730-039	91,00	1
Accesorio superficie 720 60x60	72096230-039	61,00	1
Accesorio superficie 720 120x30	72096430-039	71,00	1



Simon | 726
Luminaria modular

ESSENTIALS

726.70

CONTROL	K	LM	W	ARTÍCULO	PVR	PIEZAS
---------	---	----	---	----------	-----	--------

ÓPTICA: CONFORT 90° UGR<19

On - Off	3000	3100	36	72670033-683	58,00	1
On - Off	4000	3200	36	72670033-684	58,00	1
On - Off	5000	3200	36	72670033-685	58,00	1
DALI 2	3000	3100	36	72670333-683	108,00	1
DALI 2	4000	3200	36	72670333-684	108,00	1
DALI 2	5000	3200	36	72670333-685	108,00	1

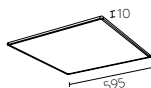

ÓPTICA: GENERAL 120°

On - Off	3000	3260	36	72670033-883	50,00	1
On - Off	4000	3400	36	72670033-884	50,00	1
On - Off	5000	3400	36	72670033-885	50,00	1
1-10V	4000	3400	36	72670133-884	75,00	1
DALI 2	3000	3260	36	72670333-883	97,00	1

726.61

CONTROL	K	LM	W	ARTÍCULO	PVR	PIEZAS
---------	---	----	---	----------	-----	--------

ÓPTICA: OPAL 120° , PERFILERÍA VISTA

On - Off	4000	3200	39	72661033-884	89,00	1
1-10V	4000	3200	39	72661133-884	115,00	1
DALI / Push	4000	3200	39	72661333-884	130,50	1

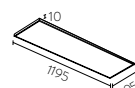

ACCESORIOS

DESCRIPCIÓN	INSTALACIÓN	ARTÍCULO	PVR	PIEZAS
Kit conexión rápida 2+2 - polos	-	72095830-039	34,00	1
Acc. para techos escayola para 720 y 726 60x60	-	72095030-039	51,00	1
Acc. para techos escayola para 720 y 726 120x30	-	72095130-039	62,50	1
Acc. perfil oculto para 720 y 726 60x60	-	72095630-039	79,50	1
Acc. perfil oculto para 720 y 726 120x30	-	72095730-039	91,00	1
Acc. suspensión 726.7 / 726.8	Suspensión	72697000-039	26,00	1
Acc. empotrar 726.7 / 726.8	Empotrar	72697030-039	6,00	1
Acc. superficie 726 60x60	Superficie	72695230-039	45,00	1
Acc. superficie 726 120x30	Superficie	72695430-039	55,50	1





CONTROL K LM W ARTÍCULO PVR PIEZAS

LUMINARIA MODULAR: 60X60

On - Off Low Glare	3000	3100	36	N 72950033-683	45,00	1
On - Off Low Glare	4000	3200	36	N 72950033-684	45,00	1
On - Off Low Glare	5000	3200	36	N 72950033-685	45,00	1
On - Off	3000	3100	36	N 72950033-883	35,00	1
On - Off	4000	3200	36	N 72950033-884	35,00	1
On - Off	5000	3200	36	N 72950033-885	35,00	1
DALI 2 Low Glare	3000	3100	36	N 72950333-683	70,00	1
DALI 2 Low Glare	4000	3200	36	N 72950333-684	70,00	1
DALI 2 Low Glare	5000	3200	36	N 72950333-685	70,00	1

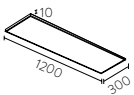
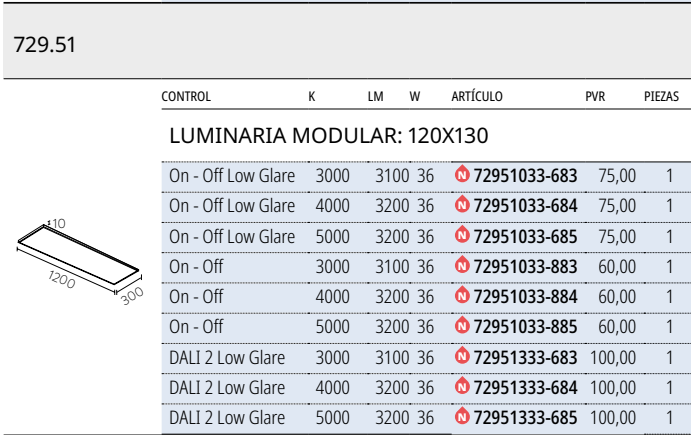
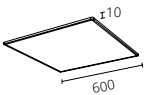

ACCESORIOS

DESCRIPCIÓN	INSTALACIÓN	ARTÍCULO	PVR	PIEZAS
Accesorio de luminaria 729.50	Superficie	N 72950530-039	41,00	1
Accesorio de luminaria 729.50	Empotrar	N 72950730-039	45,00	1
Accesorio de luminaria 729.51	Superficie	N 72951630-039	53,50	1
Accesorio de luminaria 729.51	Empotrar	N 72951830-039	55,00	1
Accesorio sluminaria 729.50/51	Suspensión	N 72992000-039	24,00	1
Accesorio grapa 729 729.50/51	Empotrar	N 72992030-039	5,50	1

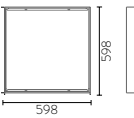

ÓPTICAS K LM W ARTÍCULO PVR PIEZAS

ON-OFF / SUSPENDIDA

Intensive 55°	4000	11500	90	81640038-384	262,00	1
Intensive 55°	5000	11700	90	81640038-385	262,00	1
General 90°	4000	11500	90	81640038-784	262,00	1
General 90°	5000	11700	90	81640038-785	262,00	1
Intensive 55°	4000	19500	160	81641038-384	393,00	1
Intensive 55°	5000	20000	160	81641038-385	393,00	1
General 90°	4000	19500	160	81641038-784	393,00	1
General 90°	5000	20000	160	81641038-785	393,00	1
Intensive 55°	4000	26400	200	81643038-384	474,00	1
Intensive 55°	5000	27600	200	81643038-385	474,00	1
General 90°	4000	26200	200	81643038-784	474,00	1
General 90°	5000	27400	200	81643038-785	474,00	1

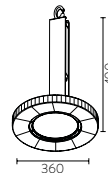

DALI / SUSPENDIDA

Intensive 55°	4000	11500	90	81640338-384	369,00	1
Intensive 55°	5000	11700	90	81640338-385	369,00	1
General 90°	4000	11500	90	81640338-784	369,00	1
General 90°	5000	11700	90	81640338-785	369,00	1
Intensive 55°	4000	19500	160	81641338-384	512,00	1
Intensive 55°	5000	20000	160	81641338-385	512,00	1
General 90°	4000	19500	160	81641338-784	512,00	1
General 90°	5000	20000	160	81641338-785	512,00	1
Intensive 55°	4000	26400	200	81643338-384	607,00	1
Intensive 55°	5000	27600	200	81643338-385	607,00	1
General 90°	4000	26200	200	81643338-784	607,00	1
General 90°	5000	27400	200	81643338-785	607,00	1

816.44

ÓPTICAS K LM W ARTÍCULO PVR PIEZAS

ON-OFF / SUSPENDIDA

Intensive 55°	4000	30600	240	81644038-384	533,00	1
Intensive 55°	5000	31900	240	81644038-385	533,00	1
General 90°	4000	30900	240	81644038-784	533,00	1
General 90°	5000	32200	240	81644038-785	533,00	1

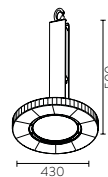

DALI / SUSPENDIDA

Intensive 55°	4000	30600	240	81644338-384	666,00	1
Intensive 55°	5000	31900	240	81644338-385	666,00	1
General 90°	4000	30900	240	81644338-784	666,00	1
General 90°	5000	32200	240	81644338-785	666,00	1



Simon 716
Luminaria industrial

ESSENTIALS

716



ÓPTICAS (°)	K	LM	W	ARTÍCULO	PVR	PIEZAS
1-10V, SUSPENDIDO						
General 100°	4000	13514	100	71640138-784	234,00	1
General 100°	4000	20310	150	71641138-784	282,00	1
General 100°	4000	25828	200	71642138-784	340,00	1



Simon 780
Luminaria industrial

ESSENTIALS

780.36

SUPERFICIE/PARED/SUSPENDIDO (IP65)

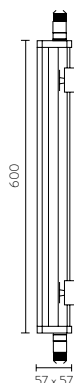

ÓPTICAS (°)	K	LM	W	ARTÍCULO	PVR	PIEZAS
ON-OFF						
General 120°	4000	2100	20	78036033-884	69,50	1
General 120°	5000	2300	20	78036033-885	69,50	1
DALI2						
General 120°	4000	2100	20	78036333-884	188,50	1
General 120°	5000	2300	20	78036333-885	188,50	1
1-10V						
General 120°	4000	2100	20	78036133-884	116,50	1
General 120°	5000	2300	20	78036133-885	116,50	1

780.37

SUPERFICIE/PARED/SUSPENDIDO (IP65)

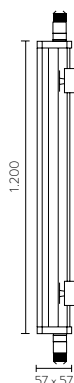

ÓPTICAS (°)	K	LM	W	ARTÍCULO	PVR	PIEZAS
ON-OFF						
General 120°	4000	4200	40	78037033-884	86,50	1
General 120°	5000	4400	40	78037033-885	86,50	1
DALI2						
General 120°	4000	4200	40	78037333-884	218,50	1
General 120°	5000	4400	40	78037333-885	218,50	1
1-10V						
General 120°	4000	4200	40	78037133-884	134,50	1
General 120°	5000	4400	40	78037133-885	134,50	1

780.38

SUPERFICIE/PARED/SUSPENDIDO (IP65)

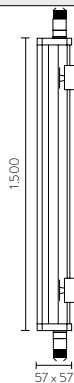

ÓPTICAS (°)	K	LM	W	ARTÍCULO	PVR	PIEZAS
ON-OFF						
General 120°	4000	5700	50	78038033-884	98,50	1
General 120°	5000	5900	40	78038033-885	98,50	1
DALI2						
General 120°	4000	5700	40	78038333-884	248,50	1
General 120°	5000	5900	40	78038333-885	248,50	1
1-10V						
General 120°	4000	5700	40	78038133-884	188,50	1
General 120°	5000	5900	40	78038133-885	188,50	1

CONDICIONES GENERALES DE VENTA Y SUMINISTRO DE SIMON SA

GENERAL

La aceptación por parte de SIMON S.A. de un pedido supone, en cualquier caso, que el cliente acepta las condiciones generales de venta y suministro detalladas en el presente documento.

PRECIOS

Los precios de venta recomendados (PVR) son los indicados en nuestra Tarifa en vigor en la fecha de pedido. Las tarifas podrán modificarse en cualquier momento sin previo aviso y se actualizarán en las plataformas habituales de consulta (Electronet, Telematel y Tarifec). Los precios indicados en ella son antes de impuestos e irán siempre a cargo del cliente.

Los precios de productos especiales o productos no incluidos en la Tarifa deberán consultarse y su valoración en el momento de la petición será independiente y no tendrá necesariamente relación con cotizaciones o pagos realizados con anterioridad sobre dichos productos.

PEDIDOS

Se considera pedido en firme la recepción de un documento escrito en cualquier formato .pdf, .doc, .xls, recibido vía e-mail (pedidos@simon.es) o por las plataformas EDI (Electro Net o PTL) que incorpore la descripción de los materiales solicitados, referencia de pedido, plazo de entrega solicitado, lugar de entrega previsto y cualquier dato que pueda precisarse para su correcta validación en su proceso de aceptación de la factura.

Tras su recepción, el departamento de Atención al Cliente verificará que los datos y condiciones del mismo sean los correctos y enviará la confirmación de recepción del pedido al cliente. Si pasado 1 día laborable de dicho envío de confirmación al cliente, no se notifica ninguna disconformidad al mismo, se considerará el pedido aceptado en todos sus términos.

En caso que el pedido recibido no coincidiera con las condiciones estipuladas, le será comunicado para su modificación o anulación. Los pedidos se suministrarán siempre en unidades de embalaje completas según viene indicado en nuestra tarifa vigente.

MODIFICACIÓN, AMPLIACIÓN O CANCELACIÓN DE PEDIDOS

No se podrán modificar, ampliar o anular pedidos que se encuentren en preparación o se hayan ya enviado. En caso de querer anular un pedido ya enviado y en un plazo máximo de 2 meses a partir de su entrega, los gastos y en un plazo máximo de 2 meses a partir de su entrega a partir de su entrega, los gastos de transporte, tanto del envío como de su devolución, irán a cargo del cliente. En ningún caso se aceptará la devolución o anulación de un producto a medida fabricado exclusivamente para el cliente.

PLAZOS DE ENTREGA

Los plazos de entrega dados por SIMON S.A. tienen un carácter puramente informativo y serán siempre orientativos, por lo que los retrasos que pudiesen existir no implicarán la cancelación del pedido ni la imputación de penalizaciones ni indemnizaciones por dicha demora. Las causas de fuerza mayor nos dan derecho a demorar el plazo de entrega sin previo aviso mientras perdure dicha afectación.

DEVOLUCIONES

Las devoluciones deberán ser siempre autorizadas por el comercial responsable de su cuenta y deberán llegar a nuestro almacén identificadas con el documento de "autorización de la devolución" en un lugar visible en el exterior del embalaje.

Cualquier bulto que no esté debidamente identificado será rechazado y devuelto a su origen.

Los envíos de material en concepto de devolución se realizan a portes pagados por el cliente.

Sólo se aceptarán productos que aparezcan en nuestra tarifa en vigor.

Condiciones:

- Las devoluciones por **anulación de pedido** (siempre que esté aprobado por dirección comercial) se abonarán al precio facturado con un demérito del 5%. El pedido debe tener una antigüedad máxima de 2 meses.
- Las devoluciones en concepto de **regularización de stock** deberán estar siempre autorizadas por el Director de Área y acompañadas de un pedido compensatorio por el doble de valor del importe de la devolución. En este caso, los costes de gestión, manipulación y acondicionamiento de las devoluciones por acuerdos comerciales supondrán un demérito del 20% aplicado sobre el precio de dos tarifas anteriores a la actualmente en vigencia.

No se aceptará ninguna devolución debida a material sobrante de una obra.

Solo se aceptarán aquellos productos y cantidades que figuren en el documento de autorización de la devolución.

Todos los productos deberán llegar a nuestro almacén en su embalaje original, en perfecto estado y en cajas completas.

Si el cliente envía más material, referencias diferentes a las autorizadas o material no apto para su venta (cajas o material en mal estado, cajas incompletas..), este material no se abonará.

El cliente tiene 10 días desde la fecha de comunicación del abono y de las referencias no abonadas para retirar este material de nuestro almacén. Después de esa fecha, le material será destruido y no podrá ser devuelto al cliente.

TRANSPORTES, SUMINISTRO y RECLAMACIONES

Los portes serán pagados por SIMON S.A. a partir de pedidos superiores a 300€ (valor neto del pedido) dentro de la península Ibérica, Baleares y para Canarias. Cualquier pedido que no llegue a ese importe se le cargará los portes en factura (20€ para la península Ibérica, Baleares y 50€ para Canarias).

El cliente tiene la obligación de revisar la mercancía a la entrega y de conformar el albarán del transportista con el sello de su empresa, su nº de DNI y la fecha de recepción. En caso de que el producto presente daños, rotura, avería, robo o extravío, el receptor de la mercancía deberá reclamarlo en el correo clientes@simon.es dentro del plazo máximo de las 48 horas laborales siguientes a la recepción de la mercancía. A partir de este tiempo SIMON S.A. queda exento de toda responsabilidad.

El material se entregará exclusivamente en los almacenes del Cliente o en cualquiera de sus puntos de venta clasificados, a menos que excepcionalmente se acuerde otra cosa por escrito. En este caso la pérdida, sustracción o rotura del bulto, sería a cargo del Cliente solicitante sin derecho alguno a su reclamación.

Transcurridos 10 días naturales de la fecha de entrega de la mercancía, SIMON S.A. no aceptará reclamaciones por diferencia en referencia o cantidad.

CONDICIONES DE GARANTÍA

Los productos SIMON, S.A. tienen una garantía de 3 años, a contar desde la fecha de la factura, siempre que hayan sido debidamente almacenados, instalados y mantenidos.

ALCANCE DE LA GARANTÍA

La garantía cubrirá la reparación o sustitución (a decisión de SIMON S.A.) de los elementos que hayan sido reconocidos por SIMON, SA como defectuosos, bien por defectos de material o por defectos de fabricación o ensamblaje. En ningún caso cubrirá la mano de obra destinada a la reinstalación de dicho material.

La reparación o sustitución de un elemento defectuoso del suministro no varía la fecha de inicio del periodo de garantía, sin embargo el elemento reparado o sustituido tendrá 1 año de garantía a partir de su sustitución.

Cuando por motivos de urgencia se deba hacer una reposición inmediata, el Cliente se compromete a devolver el material antes de 30 días naturales a partir de la recepción de la nueva pieza. En el caso de no recibir la pieza dañada en ese periodo, se procederá a su facturación.

Quedan expresamente fuera del alcance de esta garantía la mano de obra, los trabajos de instalación o desinstalación de los productos, el desgaste habitual, el mantenimiento de los equipos, la sustitución de baterías y consumibles y en general cualquier otro servicio no incluido y detallado en el párrafo anterior.

En ningún caso SIMON S.A. se hará cargo de las reparaciones hechas por personal ajeno a su organización, a menos que haya sido contratado a ese efecto por SIMON S.A.

GESTIÓN DE MATERIAL EN PRESUNTA GARANTÍA:

Cualquier reclamación de material fabricado por SIMON S.A. en concepto de garantía deberá comunicarse:

- A través de un formulario que encontrareis en nuestra página web, en el siguiente link:

<https://www.simonelectric.com/contacta>

- Vía nuestra plataforma B2B, si tiene acceso, en el apartado de incidencias y deberá cumplir las siguientes condiciones:

1. La solicitud deberá proceder del Cliente que ha comprado el material a SIMON S.A.
2. Para material correspondiente a las familias de iluminación, PRVE y electrónica el Cliente deberá rellenar un formulario adjuntando:
 - a. Factura de compra,
 - b. Foto del material defectuoso
 - c. Breve descripción del problema
3. Si por la fecha de la factura el material está en garantía SIMON SA puede optar por:
 - a. Abonar del material
 - b. Reponer el material
 - c. Optar por una reposición en consigna sujeta al análisis del material. En este caso, y una vez recibido el material en reposición, el Cliente tendrá 60 días naturales para devolver el material defectuosos para su análisis. Una vez analizado si el fallo hubiese sido causado por un defecto de instalación o uso indebido, SIMON SA procedería a facturar el material enviado en consigna. Lo mismo ocurriría si pasados 60 días naturales de la reposición, el material no hubiese sido devuelto para su análisis.
4. Documentación para la devolución: Una vez hecha la reposición, el Servicio de Atención Técnica (SAT) enviará al Cliente una etiqueta con la Dirección de envío y el número de autorización de devolución. Esta etiqueta deberá ir pegada de forma visible en el exterior de la caja para su identificación para evitar que sea rechazada por nuestros almacenes
5. Portes: Los portes de envío del material de reposición y devolución del material defectuoso serán a cargo de SIMON S.A. En caso que no procediere la garantía, SIMON S.A. facturaría al Cliente, tanto el material enviado, como los portes de envío y recepción correspondientes.

ANULACIÓN DE GARANTÍA

La garantía perderá su efecto en los supuestos de mal uso, uso inadecuado, manipulación indebida, deterioro del producto debido a agentes externos, mantenimiento inadecuado, falta de limpieza o uso de recambios no originales de la marca. Asimismo no estarán amparadas por la garantía las averías o falta de funcionamiento producidas por voltajes, frecuencias e instalaciones eléctricas incorrectas, actos vandálicos o desperfectos o incidencias ocasionados por fuerza mayor (como pueden ser guerras, terremotos, incendios, inundaciones, etc).

PAGOS

Las condiciones generales de cobro serán las pactadas con el Delegado Comercial a principio del año.

FUEROS

Para todas las discrepancias que se deriven de la presente operación, cliente y vendedor se someten expresamente a la competencia de los jueces y tribunales de Barcelona.

TASAS ECORAEES

SIMON S.A cumple con la directiva de residuos de aparatos eléctricos y electrónicos RAEE según la directiva promulgada por la Comunidad Europea 2002/96/CE de RAEE, posteriormente traspuesta a la legislación española por RD 208/2005.



www.simonelectric.com



SIMON, S.A.U.

Sáncho de Ávila, 66
08018 Barcelona
Tel. 651 761 336

Departamento de Proyectos

Tel. 651 761 346
E-mail: proyectos@simon.es

Customer Service

Tel. 651 761 314

**Servicio de Atención
Técnica al Cliente**

Tel. 651 761 346
E-mail: sat@simon.es

Visítanos en:

La Casa de la Llum (Barcelona)

Sancho de Ávila, 66
08018 Barcelona
Tel. 630 927 001
E-mail: lacasadelallum@simonelectric.com

La Casa de la Luz (Madrid)

Santa Cruz de Marcenado, 1
28015 Madrid
Tel. 630 893 497
E-mail: lacasadelaluz@simonelectric.com